



ATSC

ADVANCED TELEVISION
SYSTEMS COMMITTEE

ATSC Standard: Link-Layer Protocol (A/330)

Doc. A/330:2016
19 September 2016

Advanced Television Systems Committee
1776 K Street, N.W.
Washington, D.C. 20006
202-872-9160

The Advanced Television Systems Committee, Inc., is an international, non-profit organization developing voluntary standards for digital television. The ATSC member organizations represent the broadcast, broadcast equipment, motion picture, consumer electronics, computer, cable, satellite, and semiconductor industries.

Specifically, ATSC is working to coordinate television standards among different communications media focusing on digital television, interactive systems, and broadband multimedia communications. ATSC is also developing digital television implementation strategies and presenting educational seminars on the ATSC standards.

ATSC was formed in 1982 by the member organizations of the Joint Committee on InterSociety Coordination (JCIC): the Electronic Industries Association (EIA), the Institute of Electrical and Electronic Engineers (IEEE), the National Association of Broadcasters (NAB), the National Cable Telecommunications Association (NCTA), and the Society of Motion Picture and Television Engineers (SMPTE). Currently, there are approximately 150 members representing the broadcast, broadcast equipment, motion picture, consumer electronics, computer, cable, satellite, and semiconductor industries.

ATSC Digital TV Standards include digital high definition television (HDTV), standard definition television (SDTV), data broadcasting, multichannel surround-sound audio, and satellite direct-to-home broadcasting.

Note: The user's attention is called to the possibility that compliance with this standard may require use of an invention covered by patent rights. By publication of this standard, no position is taken with respect to the validity of this claim or of any patent rights in connection therewith. One or more patent holders have, however, filed a statement regarding the terms on which such patent holder(s) may be willing to grant a license under these rights to individuals or entities desiring to obtain such a license. Details may be obtained from the ATSC Secretary and the patent holder.

Revision History

Version	Date
Candidate Standard approved	25 December 2015
Standard approved	19 September 2016

Table of Contents

1. SCOPE	6
1.1 Organization	6
2. REFERENCES	6
2.1 Normative References	6
3. DEFINITION OF TERMS	7
3.1 Compliance Notation	7
3.2 Treatment of Syntactic Elements	7
3.2.1 Reserved Elements	7
3.3 Acronyms and Abbreviation	8
3.4 Terms	8
3.5 Extensibility	9
4. LINK LAYER OVERVIEW	9
4.1 Services	10
4.1.1 Packet Encapsulation	10
4.1.2 Overhead Reduction	11
4.1.3 Signaling Transmission	11
4.2 System Architecture	11
5. ALP PACKET FORMAT	12
5.1 ALP packet Encapsulation	12
5.1.1 Base Header	12
5.1.2 Additional Headers	14
5.1.3 Optional Header Extension	17
5.2 Signaling Encapsulation	18
5.2.1 Additional Header for Signaling Information	19
5.3 Packet Type Extension	20
5.3.1 Additional Header for type extension	21
5.4 MPEG-2 TS Packet Encapsulation	21
5.4.1 SYNC Byte Removal	23
5.4.2 Null Packet Deletion	23
5.4.3 TS Packet Header Deletion	24
6. IP HEADER COMPRESSION.....	24
6.1 ROHC-U (Robust Header Compression – Unidirectional Mode)	25
6.2 Adaptation	26
6.2.1 Extraction of Context Information	27
6.2.2 Transmission of Context	29
7. LINK LAYER SIGNALING.....	32
7.1 Table Format for Link Layer Signaling	32
7.1.1 Link Mapping Table (LMT)	32
7.1.2 ROHC-U Description Table (RDT)	35
ANNEX A : ALP PACKET FORMAT EXAMPLES	38
A.1 ALP packet Encapsulation	38
A.1.1 Single Packet Encapsulation	38
A.1.2 Segmentation	39

A.1.3	Concatenation	40
A.2	MPEG-2 TS Packet Encapsulation	41
A.2.1	Using Null packet deletion	41
A.2.2	Using TS Header deletion	42
ANNEX B : IP HEADER COMPRESSION EXAMPLES		45
B.1	Using Adaptation Mode 1	45
B.2	Using Adaptation Mode 2	46
B.3	Using Adaptation Mode 3	47

Index of Figures

Figure 4.1	ATSC 3.0 link layer logical diagram.....	10
Figure 4.2	Block diagram of the architecture and interface of ALP.....	11
Figure 5.1	ALP Packet format.	12
Figure 5.2	Structure of base header for ALP packet encapsulation.....	12
Figure 5.3	Structure of the additional header for single packets.	15
Figure 5.4	Structure of the additional header for segmentation.....	15
Figure 5.5	Structure of additional header for concatenation.....	16
Figure 5.6	Structure of ALP signaling packets (base header and additional header).	19
Figure 5.7	Structure of packet type extension (base header and additional header).....	20
Figure 5.8	Structure of the header for MPEG-2 TS packet encapsulation.	22
Figure 5.9	Null TS packet deletion example.....	24
Figure 5.10	TS header deletion example.	24
Figure 6.1	Functional structure of IP header compression.	25
Figure 6.2	Procedure for IP header compression using adaptation mode 1.....	27
Figure 6.3	Procedure for IP header compression using adaptation mode 2.....	28
Figure 6.4	Procedure for IP header compression using adaptation mode 3.....	29
Figure 6.5	Transmission of context information.....	30
Figure 6.6	Context acquisition procedure in receiver side.....	31
Figure 7.1	Example of Link Mapping for a PLP.	33
Figure A.1.1	Single Packet Encapsulation (short packet).....	38
Figure A.1.2	Single Packet Encapsulation (long packet).....	38
Figure A.1.3	Segmented Packet Encapsulation.	39
Figure A.1.4	Concatenated Packet Encapsulation.	40
Figure A.1.5	Concatenated Packet Encapsulation (odd number of component_length field)..	40
Figure A.2.1	MPEG-2 TS encapsulation example.....	41
Figure A.2.2	MPEG-2 TS encapsulation example using Null Packet Deletion.	42
Figure A.2.3	MPEG-2 TS decapsulation example using Null Packet Deletion.	42
Figure A.2.4	MPEG-2 TS encapsulation example using TS header deletion.....	43
Figure A.2.5	MPEG-2 TS decapsulation example using TS header deletion.....	44
Figure B.1.1	Example of IP header compression using adaptation mode 1.	45
Figure B.2.1	Example of IP header compression using adaptation mode 2.	46
Figure B.3.1	Example of IP header compression using adaptation mode 3.	47

Index of Tables

Table 5.1 Header Syntax for ALP Packet Encapsulation.....	13
Table 5.2 Code Values for <code>packet_type</code>	13
Table 5.3 Payload Configuration (PC) Field Value and Total Header Length	14
Table 5.4 Syntax of Additional Header for Single Packet	15
Table 5.5 Syntax of the Additional Header for Segmentation	16
Table 5.6 Syntax of Additional Header for Concatenation	17
Table 5.7 Syntax for Sub Stream Identification	18
Table 5.8 Syntax for Header Extension	18
Table 5.9 Code Values for Extension Type	18
Table 5.10 Syntax of Additional Header for Signaling Information.....	19
Table 5.11 Code Values for Signaling Type	19
Table 5.12 Code Values for Signaling Format.....	20
Table 5.13 Code Values for Signaling Encoding	20
Table 5.14 Syntax of Additional Header for Type Extension.....	21
Table 5.15 Code Values for Extended Type	21
Table 5.16 ATSC3.0 Link Layer Packet Header Syntax for MPEG-2 TS.....	22
Table 6.1 ROHC profile for ATSC 3.0	25
Table 7.1 Additional Header Values for LMT	33
Table 7.2 Syntax for Link Mapping Table.....	34
Table 7.3 Additional Header Values for RDT	35
Table 7.4 Syntax of ROHC-U Description Table	36
Table 7.5 Code Values for Adaptation Mode	36

ATSC Standard: Link-Layer Protocol

1. SCOPE

This standard defines the ATSC Link-Layer Protocol (ALP). ALP corresponds to the data link layer in the OSI 7-layer model. ALP provides a path to deliver IP packets, link layer signaling packets, and MPEG-2 Transport Stream (TS) packets down to the RF Layer and back, after reception. ALP also optimizes the proportion of useful data in the ATSC 3.0 Physical Layer by means of efficient encapsulation and overhead reduction mechanisms for IP and MPEG-2 TS transport. ALP provides extensible headroom for future use.

This standard consists of the following functions:

- ALP Packet Format
- IP header compression
- Link layer signaling

1.1 Organization

This document is organized as follows:

- Section 1 – Outlines the scope of this document and provides a general introduction.
- Section 2 – Lists references and applicable documents.
- Section 3 – Provides a definition of terms, acronyms, and abbreviations for this document.
- Section 4 – Link Layer Overview
- Section 5 – ALP Packet Format
- Section 6 – IP Header Compression
- Section 7 – Link Layer Signaling
- Annex A – ALP Packet Format Examples
- Annex B – IP Header Compression Examples

2. REFERENCES

All referenced documents are subject to revision. Users of this Standard are cautioned that newer editions might or might not be compatible.

2.1 Normative References

The following documents, in whole or in part, as referenced in this document, contain specific provisions that are to be followed strictly in order to implement a provision of this Standard.

- [1] ATSC: “ATSC Standard: Physical Layer Protocol,” Doc. A/322:2016, Advanced Television Systems Committee, Washington, D.C., 7 September 2016.
- [2] ATSC: “ATSC Candidate Standard: Signaling, Delivery, Synchronization, and Error Protection,” Doc. A/331, Advanced Television Systems Committee, Washington, D.C., 21 June 2016. *Work in process.*
- [3] IEEE: “Use of the International Systems of Units (SI): The Modern Metric System,” Doc. SI 10, Institute of Electrical and Electronics Engineers, New York, N.Y.
- [4] IETF: “Internet Protocol,” Doc. STD05 (originally RFC 791), Internet Engineering Task Force, Reston, VA, September 1981.

- [5] IETF: “User Datagram Protocol”, Doc. STD06 (originally RFC 768), Internet Engineering Task Force, Reston, VA, August 1980.
- [6] ISO/IEC: 13818-1:2013(E), “Information technology – Generic coding of moving pictures and associated audio information: Systems – Part 1.”
- [7] IETF: RFC 3095, “RObust Header Compression (ROHC): Framework and four profiles: RTP, UDP, ESP, and uncompressed”), Internet Engineering Task Force, Reston, VA, July 2001. <http://tools.ietf.org/html/rfc3095>.
- [8] IETF: RFC 4815: “RObust Header Compression (ROHC): Corrections and Clarifications to RFC 3095”, Internet Engineering Task Force, Reston, VA, February 2007. <http://tools.ietf.org/html/rfc4815>.
- [9] IETF: RFC 5795: “The RObust Header Compression (ROHC) Framework”, Internet Engineering Task Force, Reston, VA, March 2010. <http://tools.ietf.org/html/rfc5795>.

3. DEFINITION OF TERMS

With respect to definition of terms, abbreviations, and units, the practice of the Institute of Electrical and Electronics Engineers (IEEE) as outlined in the Institute’s published standards [3] shall be used. Where an abbreviation is not covered by IEEE practice or industry practice differs from IEEE practice, the abbreviation in question will be described in Section 3.3 of this document.

3.1 Compliance Notation

This section defines compliance terms for use by this document:

shall – This word indicates specific provisions that are to be followed strictly (no deviation is permitted).

shall not – This phrase indicates specific provisions that are absolutely prohibited.

should – This word indicates that a certain course of action is preferred but not necessarily required.

should not – This phrase means a certain possibility or course of action is undesirable but not prohibited.

3.2 Treatment of Syntactic Elements

This document contains symbolic references to syntactic elements used in the audio, video, and transport coding subsystems. These references are typographically distinguished by the use of a different font (e.g., `restricted`), may contain the underscore character (e.g., `sequence_end_code`) and may consist of character strings that are not English words (e.g., `dynrng`).

3.2.1 Reserved Elements

One or more reserved bits, symbols, fields, or ranges of values (i.e., elements) may be present in this document. These are used primarily to enable adding new values to a syntactical structure without altering its syntax or causing a problem with backwards compatibility, but they also can be used for other reasons.

The ATSC default value for reserved bits is ‘1.’ There is no default value for other reserved elements. Use of reserved elements except as defined in ATSC Standards or by an industry standards setting body is not permitted. See individual element semantics for mandatory settings and any additional use constraints. As currently-reserved elements may be assigned values and meanings in future versions of this Standard, receiving devices built to this version are expected

to ignore all values appearing in currently-reserved elements to avoid possible future failure to function as intended.

3.3 Acronyms and Abbreviation

The following acronyms and abbreviations are used within this document.

ALP – ATSC Link-layer Protocol

ATSC – Advanced Television Systems Committee

bslbf – bit string, left bit first

CID – Context Identifier

IANA – Internet Assigned Numbers Authority

IETF – Internet Engineering Task Force

IP – Internet Protocol

IR – Initialization and Refresh

IR-DYN – IR Dynamic

JSON – JavaScript Object Notation

LLS – Low Level Signaling

LMT – Link Mapping Table

MPEG – Moving Picture Experts Group

MSB – Most Significant Bit

MTU – Maximum Transmission Unit

PID – Packet Identifier

PLP – Physical Layer Pipe

PDU – Protocol Data Unit

RFC – Request For Comment (IETF standard)

ROHC – RObust Header Compression

RD – ROHC-U Description Table

SID – Sub-stream Identifier

SLS – Service Layer Signaling

SLT – Service List Table

TS – Transport Stream

UDP – User Datagram Protocol

uimsbf – unsigned integer, most significant bit first

XML – eXtensible Markup Language

3.4 Terms

The following terms are used within this document.

Additional Header – An Additional Header is part of the ALP packet header. The presence of an Additional Header depends on the specific fields of the Base Header.

Base Header – A Base Header is part of the ALP packet header. A Base Header is always included in the header of an ALP packet and the first part of an ALP packet.

Context – RFC 3095 [7] describes Context, as used herein, in the following manner: The context of the compressor is the state it uses to compress a header. The context of the decompressor is the state it uses to decompress a header. Either of these or the two in combination are usually

referred to as “context,” when it is clear which is intended. The context contains relevant information from previous headers in the packet stream, such as static fields and possible reference values for compression and decompression. Moreover, additional information describing the packet stream is also part of the context, for example information about how the IP Identifier field changes and the typical inter-packet increase in sequence numbers or timestamps.

Extension Header - An Extension Header is part of the ALP packet header. The presence of an Extension Header depends on the specific fields of the Additional Header.

multicast – (verb) to send data across (e.g., an IPv4) network to many recipients simultaneously; (noun) a set of data sent across (e.g., an IPv4) network to many recipients simultaneously.

Network Layer Packet - A Network Layer Packet is a source packet in the protocol of the data to be transported, e.g., an MPEG-2 Transport Stream packet or an Internet Protocol packet.

Null Packet – An MPEG-2 TS packet with PID equal to 0x1FFF.

reserved – Set aside for future use by a Standard.

3.5 Extensibility

The protocols specified in the present standard are designed with features and mechanisms to support extensibility. Receiving devices are expected to disregard reserved values and unrecognized or unsupported table types.

4. LINK LAYER OVERVIEW

The link layer is the layer between the physical layer and the network layer. The link layer transports the data from the network layer to the physical layer at the sending side and transports the data from the physical layer to the network layer at the receiving side as shown in Figure 4.1. While Figure 4.1 shows two logical flows between the link layer and physical layer, implementations are likely to utilize a single connection. The purpose of the link layer is to abstract all input packet types into a single format for processing by the physical layer (RF), ensuring flexibility and future extensibility for as-yet-undefined input types. In addition, processing within the link layer ensures that the input data can be transmitted in an efficient manner, for example by providing options to compress redundant information in the headers of input packets. Operations including encapsulation, compression and link layer signaling are referred to as the ATSC Link-layer Protocol (ALP) and packets created using this protocol are called ALP packets.

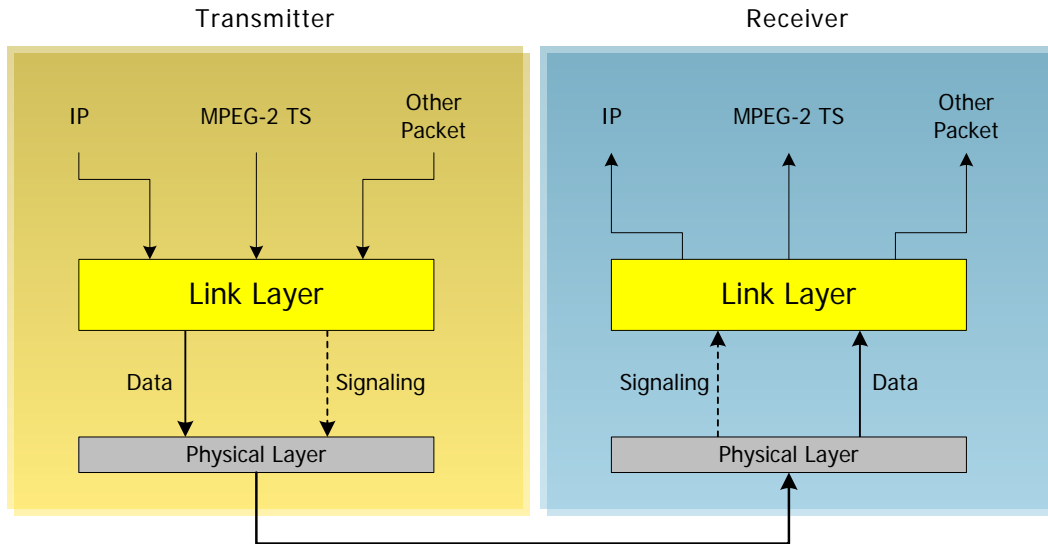

Figure 4.1 ATSC 3.0 link layer logical diagram.

4.1 Services

The services provided by ALP are briefly described below.

4.1.1 Packet Encapsulation

ALP allows encapsulation of any type of packet, including common ones such as IP [4] packets and MPEG-2 TS [6] packets. Using ALP, the physical layer need only process one single packet format, independent of the network layer protocol type (here we consider MPEG-2 TS packet as a kind of Network Layer Packet). Each Network Layer Packet or input packet is transformed into the payload of a generic ALP packet; this process is described in Section 5.1. Additionally, concatenation and segmentation can be performed in order to use the physical layer resources efficiently when the input packet sizes are particularly small or large. In this document, the term “IP packet” is used to refer to an IPv4 [4] packet unless otherwise specifically noted.

4.1.1.1 Segmentation and Reassembly

When a Network Layer Packet is too large to process easily in the physical layer, it is divided into two or more segments. The link layer packet header includes protocol fields to perform segmentation on the sending side and reassembly on the receiving side. This operation is described in Section 5.1.2.2. When the Network Layer Packet is segmented, each segment shall be encapsulated into an ALP packet and transmitted in the same order as its original position in the Network Layer Packet. Each ALP packet which includes a segment of a Network Layer Packet shall be transported within the PHY layer consecutively.

4.1.1.2 Concatenation

When the Network Layer Packet is small enough for the payload of a link layer packet to include several Network Layer Packets, the link layer packet header includes protocol fields to perform concatenation. Concatenation involves combining multiple small-sized packets into the payload of one ALP Packet. This operation is described in Section 5.1.2.3. When the Network Layer Packets are concatenated, each Network Layer Packet shall be concatenated into the payload of an ALP packet in the same order as the original input order. Also, each packet which constructs a payload of an ALP packet shall be a whole packet, not a segment of packet.

4.1.2 Overhead Reduction

Use of the ALP can result in significant reduction in overhead for transport of data on the physical layer. Two particular cases of interest are presented below: IP packets in Section 4.1.2.1 and TS packets in Section 4.1.2.2.

4.1.2.1 IP Overhead Reduction

IP packets have a fixed header format, however some of the information which is needed in a communication environment may be redundant in a broadcast environment. ALP provides mechanisms to reduce the broadcast overhead by compressing headers of IP packets including UDP [5] headers.

4.1.2.2 MPEG-2 TS Overhead Reduction

ALP provides the following overhead reduction functionality to efficiently transport MPEG-2 TS packets. First, sync byte removal provides an overhead reduction of one byte per TS packet. Secondly, a null packet deletion mechanism removes the 188-byte null TS packets in a manner such that they can be re-inserted at the receiver, and finally, a common header removal mechanism is supported.

4.1.3 Signaling Transmission

In ALP a specific format for signaling packets is provided to allow transportation of link layer signaling. This is described in Section 5.2.

4.2 System Architecture

The functional architecture block diagram and interface is shown in Figure 4.2.

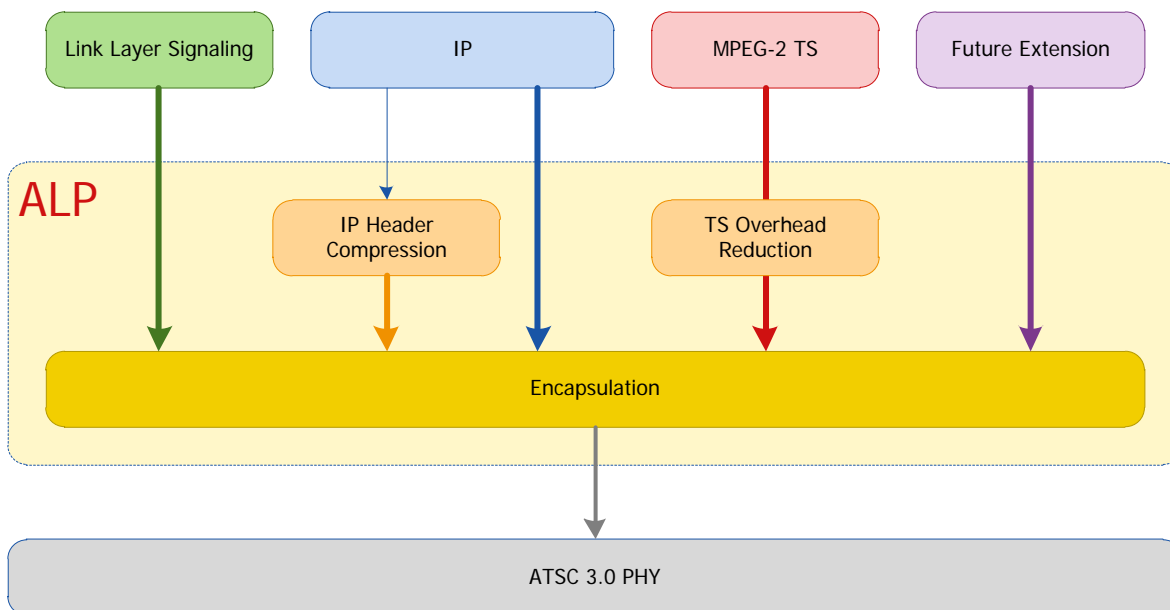

Figure 4.2 Block diagram of the architecture and interface of ALP.

ALP takes as input Network Layer Packets such as IPv4 and MPEG-2 TS as input packets. Future extension indicates other packet types and protocols which are also possible to be input in ALP. ALP also specifies the format and signaling for any link layer signaling, including information about mapping specific IP packet streams to data pipes in the physical layer. Figure

4.2 also shows how ALP incorporates mechanisms to improve the efficiency of transmission, via various header compression and deletion algorithms.

5. ALP PACKET FORMAT

An ALP packet shall consist of a header followed by a data payload. The header of an ALP packet shall always contain a Base Header, and may contain an Additional Header depending on the control fields of the Base Header. The presence of an optional Extension Header is indicated by flag fields within the Additional Header. (See Figure 5.1.)

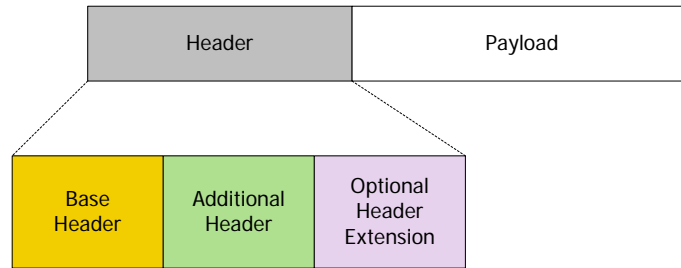

Figure 5.1 ALP Packet format.

5.1 ALP packet Encapsulation

5.1.1 Base Header

The Base Header for ALP packet encapsulation has the hierarchical structure shown in Figure 5.2. The Base Header shall always be two bytes in length and two bytes is the minimum length of the ALP packet header. An exception is when the value of packet_type is '111'. In this case, the detailed structure of encapsulation is described in Section 5.4.

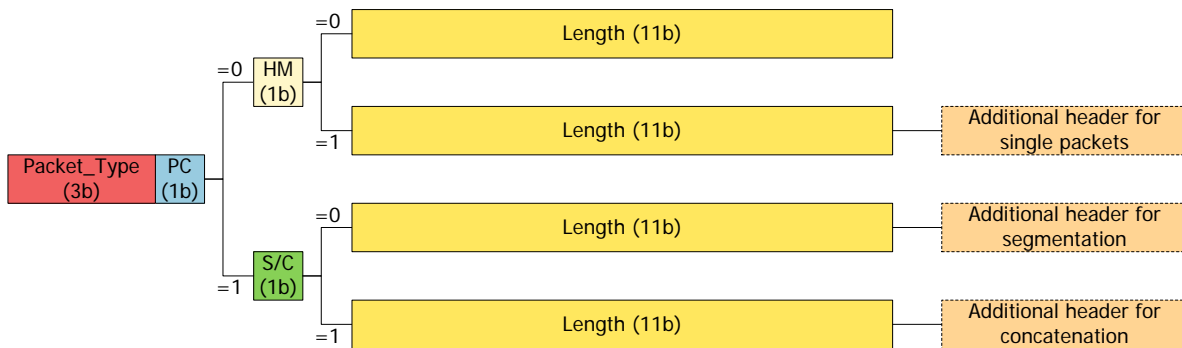

Figure 5.2 Structure of Base Header for ALP packet encapsulation.

The bit stream syntax of an ALP packet shall be as shown in Table 5.1. The text following Table 5.1 describes the semantics of each field in the table section.

Table 5.1 Header Syntax for ALP Packet Encapsulation

Syntax	No. of bits	Format
ALP_packet_header() {		
packet_type	3	uimsbf
payload_configuration	1	bslbf
if (payload_configuration == 0) {		
header_mode	1	bslbf
length	11	uimsbf
if (header_mode == 1) {		
single_packet_hdr()	var	Sec. 5.1.2.1
}		
}		
else if (payload_config == 1) {		
segmentation_concatenation	1	bslbf
length	11	uimsbf
if (segmentation_concatenation == 0) {		
segmentation_hdr()	var	Sec. 5.1.2.2
}		
else if (segmentation_concatenation == 1) {		
concatenation_hdr()	var	Sec. 5.1.2.3
}		
}		
}		

packet_type – This 3-bit field shall indicate the original protocol or packet type of the input data before encapsulation into an ALP packet as shown in Table 5.2 below. All packet types of Table 5.2 shall be encapsulated according to Table 5.1 except MPEG-2 TS packets. When MPEG-2 TS packets are encapsulated, the value of `packet_type` shall be ‘111’ and the detailed structure of encapsulation is described in Section 5.4.

Table 5.2 Code Values for `packet_type`

<code>packet_type</code> Value	Meaning
000	IPv4 packet
001	Reserved
010	Compressed IP packet
011	Reserved
100	Link layer signaling packet
101	Reserved
110	Packet Type Extension
111	MPEG-2 Transport Stream

payload_configuration (PC) – This 1-bit field shall indicate the configuration of the payload. A value of ‘0’ shall indicate that the ALP packet carries a single, whole input packet and the following field is the `header_mode` field. A value of ‘1’ shall indicate that the ALP packet carries more than one input packet (concatenation) or a part of a large input packet (segmentation) and the following field is the `segmentation_concatenation` field.

header_mode (HM) – This 1-bit field, when set to ‘0’, shall indicate there is no Additional Header for the single packet as defined in Section 5.1.2.1, and that the length of the payload of the ALP packet is less than 2048 bytes. A value of ‘1’ shall indicate that an Additional Header for the single packet as defined in Section 5.1.2.1 is present following the length field. In this case, the length of the payload is larger than 2047 bytes and/or optional features can be used (sub-stream identification, Extension Header, etc.). This field shall be present only when payload_configuration field of the ALP packet has a value of ‘0’.

segmentation_concatenation (S/C) – This 1-bit field, when set to ‘0’, shall indicate that the payload carries a segment of an input packet and an Additional Header for segmentation defined in Section 5.1.2.2 is present following the length field. A value of ‘1’ shall indicate that the payload carries more than one complete input packet and an Additional Header for concatenation defined in Section 5.1.2.3 is present following the length field. This field shall be present only when the value of payload_configuration field of the ALP packet is ‘1’.

length – This 11-bit field shall indicate the 11 least significant bits (LSBs) of the length in bytes of payload carried by the ALP packet. When there is a length_MSB field in the following Additional Header, the length field is concatenated with the length_MSB field, and represents the LSB value portion of the actual payload length.

Four types of packet configurations are thus possible: a single packet without any Additional Header, a single packet with an Additional Header, a segmented packet, and finally a concatenated packet. The header length of ALP packet is indicated separately with the combination of the fields in the Base Header and the Additional Header. These four types of packet configurations are shown with the total header length in Table 5.3.

Table 5.3 Payload Configuration (PC) Field Value and Total Header Length

PC Field Value	Meaning	Next Field	Additional Header Size	Additional Header Field	Total Header Length (excluding optional header)	
		Name				Value
0	Single packet	HM	0	-	2 bytes	
		HM	1	1 byte	length_MSB	3 bytes
1	Segmentation or Concatenation	S/C	0	1 byte	seg_SN, LSI	3 bytes
		S/C	1	1 byte	length_MSB, count	3 + [(count+1) × 1.5] bytes ¹

¹ The operation [] above is the ceiling function.

In the ALP, null-packets (which have zero-length payloads) shall not be generated. Therefore, the length field for single packet encapsulation with Base Header only, concatenated length indication with length and length_MSB field, and component_length field shall not have a value equal to ‘0’.

5.1.2 Additional Header

There are three different types of Additional Headers that need to be described: the Additional Header for single packets is described in Section 5.1.2.1, the Additional Header for segmentation is described in Section 5.1.2.2 and the Additional Header for concatenation is described in Section 5.1.2.3.

5.1.2.1 Single Packets

This Additional Header for single packets shall be present only when header_mode (HM) = ‘1’. The header_mode (HM) shall be set to ‘1’ when the length of the payload of the ALP packet is larger than

2047 bytes and/or to signal additional functionality in the single packet case. The Additional Header for single packets is shown in Figure 5.3.

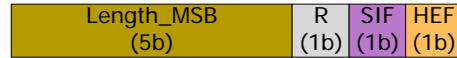

Figure 5.3 Structure of the Additional Header for single packets.

The syntax of the additional header for single packets shall be as shown in Table 5.4. The text following Table 5.4 describes the semantics of each field in the table section.

Table 5.4 Syntax of Additional Header for Single Packet

Syntax	No. of bits	Format
single_packet_hdr() {		
length_MSB	5	uimsbf
reserved	1	'1'
SIF	1	bslbf
HEF	1	bslbf
if (SIF == 1) {		
sub_stream_identification()	8	Sec. 5.1.3.1
}		
if (HEF == 1) {		
header_extension()	var	Sec. 5.1.3.2
}		
}		

length_MSB – This 5-bit field shall indicate the most significant bits (MSBs) of the total payload length in bytes in the current ALP packet, and is concatenated with the length field containing the 11 least significant bits (LSBs) to obtain the total payload length. The maximum length of the payload that can be signaled is therefore 65,535 bytes. When the payload of an ALP packet is less than 2048 bytes and the optional header needs to be added to the ALP packet, this field shall be set to all zeroes.

SIF (Sub-stream Identifier Flag) – This 1-bit field shall indicate whether the optional header for sub-stream identification is present after the HEF field or not. When there is no `sub_stream_identification()` in this ALP packet, SIF field shall be set to '0'. When there is a `sub_stream_identification()` after the HEF field in the ALP packet, SIF shall be set to '1'. The detail of the optional header for sub-stream identification is described in Section 5.1.3.1.

HEF (Header Extension Flag) – This 1-bit field, when set to '1' shall indicate an optional Header Extension is present for future extension. A value of '0' shall indicate that the Extension Header is not present.

5.1.2.2 Segmentation

The Additional Header for segmentation shall be present only when `segmentation_concatenation (S/C)` = '0'. The Additional Header for segmentation is shown in Figure 5.4.



Figure 5.4 Structure of the Additional Header for segmentation.

The syntax of the Additional Header for segmentation shall be as shown in Table 5.5. The text following Table 5.5 describes the semantics of each field in the table section.

Table 5.5 Syntax of the Additional Header for Segmentation

Syntax	No. of bits	Format
segmentation_hdr() {		
segment_sequence_number	5	uimsbf
last_segment_indicator	1	bslbf
SIF	1	bslbf
HEF	1	bslbf
if (SIF == 1) {		
sub_stream_identification()	8	Sec. 5.1.3.1
}		
if (HEF == 1) {		
header_extension()	var	Sec. 5.1.3.2
}		
}		

segment_sequence_number – This 5-bit unsigned integer shall indicate the order of the corresponding segment carried by the ALP packet. For the ALP packet which carries the first segment of an input packet, the value of this field shall be set to ‘0x0’. This field shall be incremented by one with each additional segment belonging to the segmented input packet. When segment_sequence_number is equal to ‘0x0’, last_segment_indicator shall not be equal to ‘1’.

last_segment_indicator (LSI) – This 1-bit field shall indicate, when set to ‘1’, that the segment in this payload is the last one of input packet. A value of ‘0’ shall indicate that it is not last segment.

SIF (Sub-stream Identifier Flag) – This 1-bit field shall indicate whether the optional header for sub-stream identification is present after the HEF field or not. When there is no sub_stream_identification () in the ALP packet, the SIF field shall be set to ‘0’. When there is a sub_stream_identification () after the HEF field in the ALP packet, the SIF field shall be set to ‘1’. The details of the optional header for sub-stream identification are described in Section 5.1.3.1.

HEF (Header Extension Flag) – This 1-bit field shall indicate, when set to ‘1’, that the optional Extension Header is present after the Additional Header for future extensions of the ALP header. A value of ‘0’ shall indicate that the optional Extension Header is not present.

5.1.2.3 Concatenation

This Additional Header shall be present when segmentation_concatenation (S/C) = ‘1’. The Additional Header for concatenations is shown in Figure 5.5.



Figure 5.5 Structure of Additional Header for concatenation.

The syntax of the Additional Header for concatenation shall be as shown in Table 5.6. The text following Table 5.6 describes the semantics of each field in the table section.

Table 5.6 Syntax of Additional Header for Concatenation

Syntax	No. of bits	Format
concatenation_hdr() {		
length_MSB	4	uimsbf
count	3	uimsbf
SIF	1	bslbf
for (i=0; i<count+1; i++) {		
component_length	12	uimsbf
}		
if ((count & 1) == 0) {		
stuffing_bits	4	'0000'
}		
if (SIF == 1) {		
sub_stream_identification()	var	Sec. 5.1.3.2
}		
}		

length_MSB – This 4-bit field shall indicate MSB bits of the payload length in bytes in this ALP packet. The maximum length of the payload is 32,767 bytes for concatenation.

count – This field shall indicate the number of the packets included in the ALP packet. The value of this field shall be set to (number of the packets included in the ALP packet - 2). So, the minimum number of concatenated packets is 2 and the maximum number of concatenated packets is 9 in an ALP packet.

SIF (Sub-stream Identifier Flag) – This 1-bit field shall indicate whether the optional header for sub-stream identification is present after the last `component_length` field or not. When there is no `sub_stream_identification ()` in the ALP packet, the SIF field shall be set to '0'. When there is a `sub_stream_identification ()` after the last `component_length` field in the ALP packet, the SIF field shall be set to '1'. The details of the optional header for sub-stream identification are described in Section 5.1.3.1.

component_length – This 12-bit length field shall indicate the length in bytes of each packet. `component_length` fields are included in the same order as the packets present in the payload except the last component packet. The number of length fields shall be indicated by (count+1). When an ALP header consists of an odd number of `component_length` fields, four stuffing bits shall follow after the last `component_length` field. These bits shall be set to '0'.

5.1.3 Extension Header

The ALP packet may be extended by the addition of an optional Extension Header if it is signaled by one of the fields in the Additional Header structure, that is the SIF or HEF. If the SIF flag is set, the optional header shall contain a `Sub_Stream_Identification()` structure as described in Table 5.7. If the HEF flag is set, the Extension Header exists and shall contain a `header_extension` as described in Table 5.8. If both SIF and HEF are set, the order shall be `Sub_Stream_Identification()` structure followed by `header_extension` structure.

5.1.3.1 Sub Stream Identification

The optional header for sub-stream identification is used to filter out specific packet stream in the link layer level. One example of sub-stream identification is the role of service identifier in an ALP stream carrying multiple services. The mapping information between an upper layer stream and

the SID value corresponding to the upper layer stream shall be provided as in the Link Mapping Table as specified in Section 7.1.1.

Table 5.7 Syntax for Sub Stream Identification

Syntax	No. of bits	Format
sub_stream_identification() { SID }	8	bslbf

SID (Sub-stream Identifier) – This 8-bit field shall indicate the sub stream identifier for the ALP packet. If there is an optional Extension Header, SID shall be present between the Additional Header and the optional header extension.

5.1.3.2 Header Extension

The header extension contains extended fields for future use. Receivers are expected to ignore any header extensions which they do not understand. The header extension shall consist of the fields as defined in Table 5.8. In the present version of the specification, all values for *extension_type* field are reserved.

Table 5.8 Syntax for Header Extension

Syntax	No. of bits	Format
header_extension() { extension_type extension_length_minus1 for (i=0; i<=extension_length_minus1; i++) { extension_byte } }	8 8 8	uimsbf uimsbf uimsbf

The semantic definitions for the fields are given below:

extension_type – This 8-bit field shall indicate the type of the header_extension() according to Table 5.9. When the value of extension_type is in the user private range, extension_byte data is usable for propriety implementations.

Table 5.9 Code Values for Extension Type

extension_type	Meaning
0x00–0xEF	Reserved
0xF0–0xFF	User Private

extension_length_minus1 – This 8-bit field shall indicate one less than the number of extension_byte(s) that follow..

extension_byte – A byte representing the value of the header_extension().

5.2 Signaling Encapsulation

This section provides information about how link layer signaling is incorporated into ALP packets. Signaling packets are identified by the packet_type field of the Base Header being equal to ‘100’.

Figure 5.6 shows the structure of the ALP packets containing an Additional Header for signaling information. In addition to the ALP header, the ALP packet shall consist of two additional parts, an Additional Header for signaling information and the actual signaling data itself. The total length of the ALP signaling packet is shown in the ALP packet header.

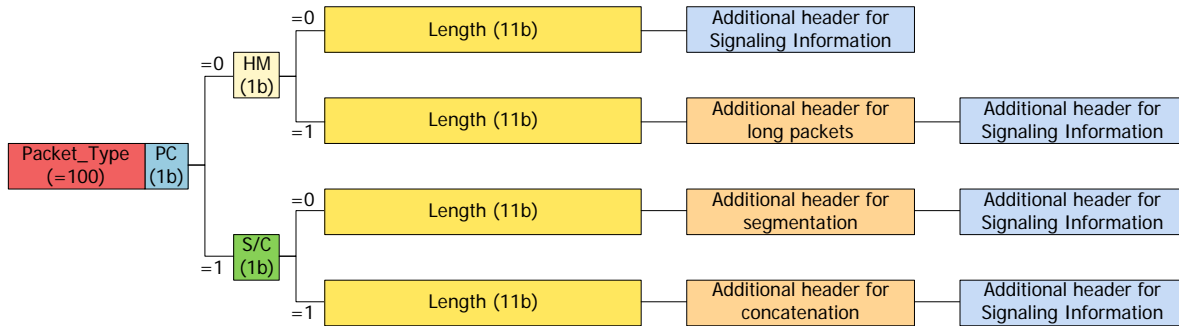

Figure 5.6 Structure of ALP signaling packets (base header and additional header).

5.2.1 Additional Header for Signaling Information

The Additional Header for signaling information `signaling_information_hdr()` shall consist of the fields as defined in Table 5.10. The text following Table 5.10 describes the semantics of each field in the table.

Table 5.10 Syntax of Additional Header for Signaling Information

Syntax	No. of bits	Format
<code>signaling_information_hdr() {</code>		
signaling_type	8	uimsbf
signaling_type_extension	16	bslbf
signaling_version	8	uimsbf
signaling_format	2	uimsbf
signaling_encoding	2	uimsbf
reserved	4	'1111'
<code>}</code>		

signaling_type – This 8-bit field shall indicate the type of signaling according to Table 5.11.

Table 5.11 Code Values for Signaling Type

signaling_type	Meaning
0x00	Reserved
0x01	Link Mapping Table (see Section 7.1.1)
0x02	ROHC-U Description Table (see Section 7.1.2)
0x03–0xEF	Reserved
0xF0–0xFF	User Private

signaling_type_extension – This 16-bit field shall indicate the attribute of the signaling. Detail of this field shall be defined in each signaling section in Section 7. This field and its value is defined within each signaling table.

signaling_version – This 8-bit field shall indicate the version of signaling. The value of this field shall be incremented by 1 whenever any data of the signaling identified by signaling_type changes. The value of signaling_version field shall wrap around to 0 after its maximum value.

signaling_format – This 2-bit field shall indicate the data format of the signaling data as described in Table 5.12.

Table 5.12 Code Values for Signaling Format

signaling_format	Meaning
00	Binary
01	XML
10	JSON
11	Reserved

signaling_encoding – This 2-bit field shall specify the encoding/compression format. The code values of signaling_encoding field are described in Table 5.13. When signaling_format field indicates Binary ('00'), the signaling_encoding shall be set to '00'.

Table 5.13 Code Values for Signaling Encoding

signaling_encoding	Meaning
00	No Compression
01	DEFLATE (RFC1951)
10	Reserved
11	Reserved

5.3 Packet Type Extension

In order to provide a mechanism to allow an almost unlimited number of additional protocol and packet types to be carried by ALP in the future, the Additional Header is defined. Packet type extension shall be used only when packet_type is '110' in the Base Header as described in Table 5.2. Figure 5.7 shows the structure of the ALP packets containing Additional Header for type extension.

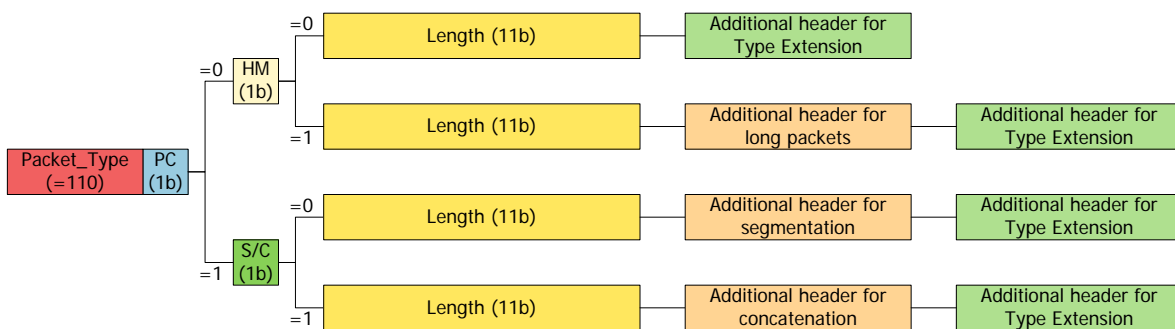

Figure 5.7 Structure of packet type extension (Base Header and Additional Header).

5.3.1 Additional Header for type extension

The Additional Header for type extension `type_extension_hdr()` shall consist of the fields as defined in Table 5.14. The text following Table 5.14 describes the semantics of each field in the table.

Table 5.14 Syntax of Additional Header for Type Extension

Syntax	No. of bits	Format
<pre>type_extension_hdr() { extended_type }</pre>	16	uimsbf

The semantic definitions for the fields are given below:

extended_type – this 16-bit field shall indicate the protocol or packet type of the input encapsulated in the ALP packet as payload. This field shall not be used for any protocol or packet type already defined in Table 5.2. In the current version of the specification, all `extended_type` values are reserved, as shown in Table 5.15.

Table 5.15 Code Values for Extended Type

extended_type	Meaning
0x00–0xFF	Reserved

5.4 MPEG-2 TS Packet Encapsulation

This section provides the ALP packet format when the input consists of MPEG-2 TS packets, that is when the `packet_type` field of the Base Header is equal to '111'. Multiple TS packets can be encapsulated within each ALP packet. The number of TS packets is signaled via the `NUMTS` field.

ALP provides overhead reduction mechanisms for MPEG-2 TS to enhance the transmission efficiency. The sync byte (0x47) of each TS packet is always deleted. The option to delete Null Packets and similar TS headers is also provided.

In order to avoid unnecessary transmission overhead, TS Null Packets (PID = 0x1FFF) may be removed. Deleted Null Packets can be recovered using the `DNP` field. The `DNP` field indicates the count of deleted Null Packets. The Null Packet deletion mechanism using the `DNP` field is described in Section 5.4.3.

In order to achieve more transmission efficiency, similar headers of consecutive MPEG-2 TS packets can be removed. When two or more successive TS packets have sequentially increasing continuity counter fields and other header fields are the same, the header is sent once at the first packet and the subsequent headers are deleted. The `HDM` field shall indicate whether the header deletion is performed or not. The detailed procedure of common TS header deletion is described in Section 5.4.4.

When multiple overhead reduction mechanisms are performed, overhead reduction shall be performed in the following sequence. First, sync removal, followed by Null Packet deletion, and then common header deletion.

5.4.1 ALP Packet Structure (for TS Packet Encapsulation)

The overall structure of the ALP packet header when using MPEG-2 TS packet encapsulation is depicted in Figure 5.8. The first byte is Base Header and the optional second byte is the Additional Header, as shown in **Figure 5.1**. The Base Header length shall be one byte, and the minimum

length of the ALP packet header in this case is one byte. When the Additional Header is present the total ALP packet header length is two bytes. Further details and the specific syntax is described in Table 5.16.

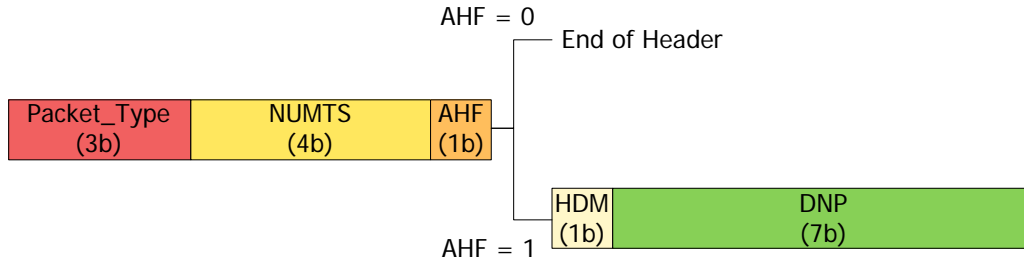

Figure 5.8 Structure of the header for MPEG-2 TS packet encapsulation.

The syntax of MPEG-2 TS packet encapsulation shall be as shown in Table 5.16. The text following Table 5.16 describes the semantics of each field in the table section.

Table 5.16 ATSC3.0 Link Layer Packet Header Syntax for MPEG-2 TS

Syntax	No. of bits	Format
ATSC3.0_link_layer_packet() {		
packet_type	3	'111'
NUMTS	4	uimsbf
AHF	1	bslbf
if (AHF == 1) {		
HDM	1	bslbf
DNP	7	uimsbf
}		
}		

packet_type – This 3-bit field shall indicate the protocol type of the input packet as defined in Table 5.2. For MPEG-2 TS packet encapsulation, this field shall always be set to ‘111’.

NUMTS (Number of TS packets) – This 4-bit field shall indicate the number of TS packets in the payload of this ALP packet. A maximum of 16 TS packets can be supported in one ALP packet. The value of NUMTS = ‘0’ shall indicate that 16 TS packets are carried by the payload of the ALP packet. For all other values of NUMTS, the same number of TS packets are recognized, e.g. NUMTS = ‘0001’ means one TS packet is carried.

AHF (Additional Header Flag) – This field shall indicate whether the Additional Header is present or not. A value of ‘0’ indicates that there is no Additional Header. A value of ‘1’ indicates that an Additional Header of length 1-byte is present following the Base Header. If null TS packets are deleted or TS header compression is applied this field shall be set to ‘1’.

The Additional Header for TS packet encapsulation consists of the following two fields and is present only when the value of AHF in this ALP packet is set to ‘1’.

HDM (Header Deletion Mode) – This 1-bit field shall indicate whether TS header deletion is applied to this ALP packet. A value of ‘1’ indicates that TS header deletion shall be applied as described

in Section 5.4.4. A value of '0' indicates that the TS header deletion method is not applied to this ALP packet.

DNP (Deleted Null Packets) –This 7-bit field shall indicate the number of deleted null TS packets prior to this ALP packet. A maximum of 128 null TS packets can be deleted. When HDM = '0' the value of DNP = '0' shall indicate that 128 Null Packets are deleted. When HDM = '1' the value of DNP = '0' shall indicate that no Null Packets are deleted. For all other values of DNP, the same number of Null Packets are recognized, e.g. DNP = '5' means 5 Null Packets are deleted.

5.4.2 SYNC Byte Removal

When encapsulating TS packets into the payload of an ALP packet, the SYNC byte (0x47) from the start of each TS packet shall always be deleted. Hence the length of the MPEG-2 TS packet encapsulated in the payload of the ALP packet is always of length 187 bytes (instead of 188 bytes originally).

5.4.3 Null Packet Deletion

Transport Stream rules require that bit rates at the output of a transmitter's multiplexer and at the input of the receiver's de-multiplexer are constant in time and the end-to-end delay is also constant. For some Transport Stream input signals, Null Packets may be present in order to accommodate variable bitrate services in a constant bitrate stream. In this case, in order to avoid unnecessary transmission overhead, TS Null Packets (that is TS packets with PID = 0x1FFF) may be removed. The process is carried out in a way that the removed Null Packets can be re-inserted in the receiver in the exact place where they were originally, thus guaranteeing constant bitrate and avoiding the need for PCR time stamp updating.

Before generation of an ALP packet, a counter used for counting deleted Null Packets shall first be reset to zero and then incremented for each deleted Null Packet preceding the first non-Null Packet to be encapsulated into the payload of the current ALP packet. The value of this counter is then used to set the DNP field. Then a group of consecutive useful TS packets is encapsulated into the payload of the current ALP packet and the value of each field in its header can be determined. After the generated ALP packet is injected to the physical layer, the DNP counter is reset to zero. When DNP counter reaches its maximum allowed value, if the next packet is also a Null Packet, this Null Packet is kept as a useful packet and encapsulated into the payload of the current ALP packet. Each ALP packet shall contain at least one useful TS packet in its payload.

Figure 5.9 shows an example when Null Packet deletion is used. In this example HDM = '0' and AHF = '1' for both ALP packets. In the first ALP packet one Null Packet is deleted before two useful TS packets are transmitted in the ALP packet. The next packet is a Null Packet, so the ALP packet is completed and the DNP counter is reset to zero. In the header for this ALP packet NUMTS = '2' and DNP = '1'. In the second ALP packet two Null Packets are deleted before transmission of 4 TS packets in the ALP packet. In the header for this packet NUMTS = '4' and DNP = '2'.

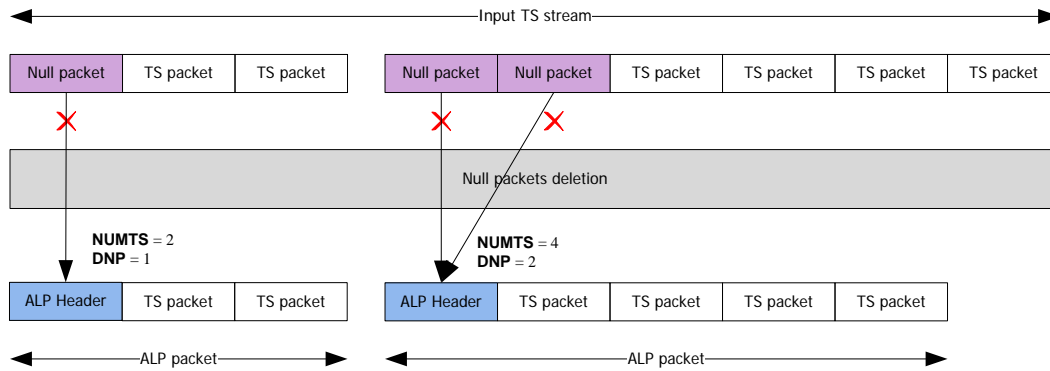

Figure 5.9 Null TS packet deletion example.

5.4.4 TS Packet Header Deletion

When two or more successive TS packets have sequentially increasing continuity counter fields and other TS packet header fields are the same, the header is sent once at the first packet and the other headers are deleted. When the duplicated MPEG-2 TS packets are included in two or more successive TS packets, the header deletion mechanism shall not be applied in the current ALP packet on the transmitter side. The HDM field shall indicate whether the header deletion is performed or not. When TS header deletion is performed, HDM shall be set to '1'.

Figure 5.10 illustrates the use of TS packet header deletion through an example. In this case three TS packets have the same header fields and the field NUMTS = '4'. HDM = '1' and DNP = '0' while AHF = '1'. In the receiver side, using the first packet header, the deleted packet headers are recovered, and the continuity counter is restored by incrementing it sequentially from that of the first header.

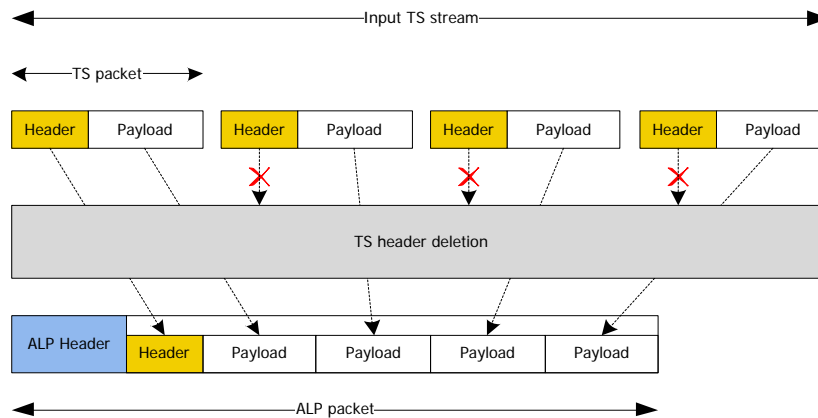

Figure 5.10 TS header deletion example.

6. IP HEADER COMPRESSION

In the ATSC 3.0 link layer, an IP header compression/decompression scheme is provided. The functional structure of IP header compression is shown in Figure 6.1. IP header compression consists of the following two parts: header compressor/decompressor and adaptation module. The header compression scheme is based on the Robust Header Compression (ROHC). In addition, for broadcasting usage, an adaptation function is added.

In the transmitter side, the ROHC Compressor reduces the size of the header for each packet. Then, an Adaptation module extracts context information and builds signaling information from each packet stream. In the receiver side, the adaptation module parses the signaling information associated with the received packet stream and attaches context information to the received packet stream. The ROHC decompressor reconstructs the original IP packet by recovering the packet header. Section 6.1 specifies references to the relevant RFCs and some restrictions of ROHC for ATSC 3.0 use. The detailed methods of packet configuration and context transmission are described in Section 6.2.

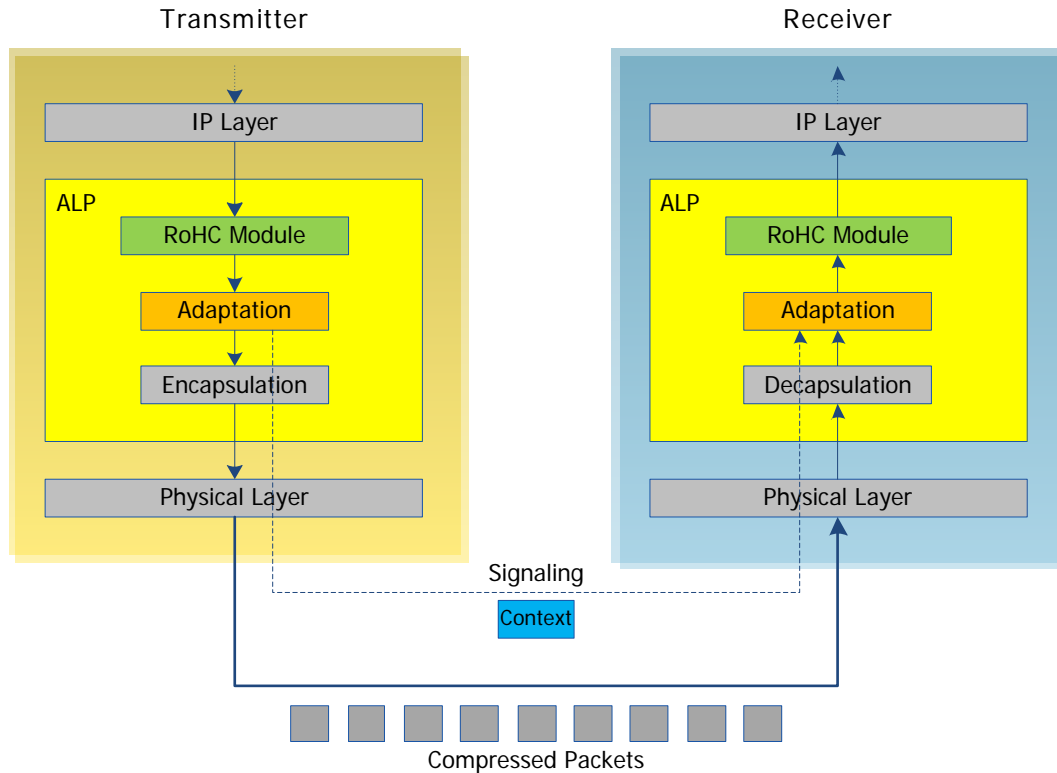

Figure 6.1 Functional structure of IP header compression.

6.1 ROHC-U (Robust Header Compression – Unidirectional Mode)

The IP header compression scheme shall be based on the Robust Header Compression. In consideration of characteristics of the ATSC 3.0 broadcasting link, the ROHC framework shall operate in the unidirectional mode (U-mode) as described in RFC 3095 [7], RFC 4815 [8] and RFC 5795 [9].

In the ROHC framework, multiple header compression profiles are defined. Each profile indicates a specific protocol combination, and the profile identifiers are allocated by the Internet Assigned Numbers Authority (IANA). For the ATSC 3.0 system, the ‘0x0002’ profile shall be used for ATSC 3.0. Table 6.1 shows the ROHC profiles defined for ATSC 3.0 system.

Table 6.1 ROHC profile for ATSC 3.0

Profile Identifier	Profile	Protocol Combination	Reference
0x0002	ROHC UDP	UDP/IP	RFC 3095 [7], RFC 4815 [8]

The ROHC framework defines channels to identify the compressed packet flow. In ATSC 3.0, the PLP should be mapped to an ROHC channel. Therefore, the CID should be managed separately at each PLP. In ROHC, each channel can define three types of CID configuration: small CID, 1-byte large CID, and 2-byte large CID. Among these configurations, small CID and 1-byte large CID should be configured for ATSC 3.0 systems.

For the protocol optimization, the following mechanisms and packet formats from the ROHC framework shall not be used.

- ROHC Padding – ALP does not provide a padding operation, however, the baseband packet of the ATSC 3.0 physical layer supports this operation. Thus, a padding operation shall not be performed in the ROHC compressor.
- ROHC Feedback – For the ATSC 3.0, a unidirectional link is used. Therefore, the feedback mechanism and format shall not be used.
- ROHC Segmentation – The segmentation of ROHC shall not be used. If the packet segmentation is required, it shall be performed in ALP encapsulation.

The ROHC framework defines configuration parameters to establish the context state between compressor and decompressor at each channel. In ATSC 3.0, the compressor sets these parameters and transmits signaling information to the decompressor.

MAX_CID – This parameter is the maximum CID value to be used by the compressor. This parameter should be signaled by the `max_CID` field in the RDT (ROHC-U Description Table) as described in Section 7.1.2.

LARGE_CIDS – This Boolean parameter indicates the CID configuration. When this parameter is ‘FALSE’, the short CID is used in this channel. When this parameter is ‘TRUE’, the long CID is used in this channel. In ATSC 3.0, this parameter should be inferred from the `max_CID` field in RDT. If `max_CID` is equal or less than ‘15’, **LARGE_CIDS** is considered as ‘FALSE’. And if `max_CID` is larger than ‘15’, **LARGE_CIDS** is considered as ‘TRUE’ in the decompressor.

PROFILES – This parameter defines which profile is used by the compressor. The list of profiles is defined in Table 6.1. This parameter is conveyed in the `context_profile` field of the RDT.

FEEDBACK_FOR – For ATSC 3.0, the feedback mechanism shall not be used. Therefore, this parameter shall not be used.

MRRU (Maximum Reconstructed Reception Unit) – In the ROHC framework, this parameter is defined for ROHC segmentation. Thus, this parameter shall not be used in the ATSC 3.0.

The detailed procedures and algorithms of compression/decompression are specified in each RFC, and the implementation of the ROHC framework and compression algorithm is out of scope in this specification.

6.2 Adaptation

In the case of transmission through a unidirectional link, if a receiver has no context information, the decompressor cannot recover the received packet header until it receives full context data. This may cause channel change delay and turn on delay. For this reason, context information and configuration parameters shall be sent in the RDT (see Section 7.1.2).

The Adaptation function at the transmitter provides construction of link layer signaling using configuration parameters and context information from the ROHC process. The adaptation function at the transmitter uses the previous configuration parameters and context information to transmit the link layer signaling periodically through each PHY frame. At the receiver, the fundamental process is reversed.

In addition, the Adaptation function provides out-of-band transmission of the configuration parameters and context information. Out-of-band transmission should be achieved through link layer signaling. By these means, the Adaptation function reduces channel change delay and decompression error due to loss of context information.

6.2.1 Extraction of Context Information

6.2.1.1 Adaptation Mode 1

Figure 6.2 shows the procedure for context extraction when the transmitter side operates in adaptation mode 1. In the adaptation mode 1, there is no additional operation performed on the original ROHC packet stream. The adaptation module shall operate as a buffer. Therefore, there is no context information such as static chain or dynamic chain in link layer signaling.

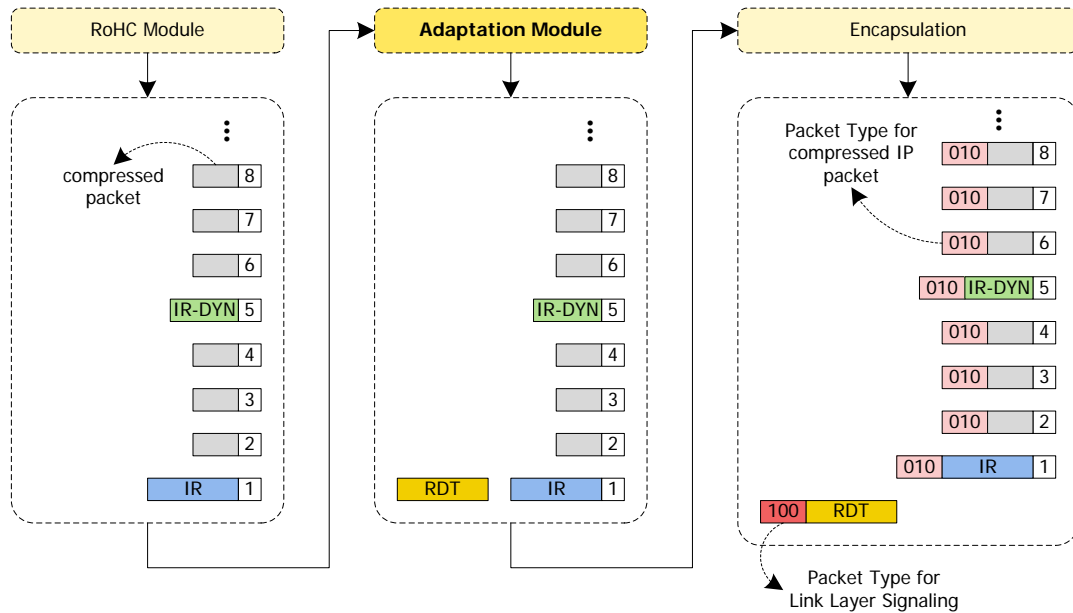

Figure 6.2 Procedure for IP header compression using adaptation mode 1.

6.2.1.2 Adaptation Mode 2

Figure 6.3 shows the procedure for context extraction when the transmitter side operates in adaptation mode 2. The adaptation module shall detect the IR packet from the ROHC packet flow and extract the context information (static chain). After extracting the context information, each IR packet shall be converted to an IR-DYN packet. The converted IR-DYN packet shall be included and transmitted inside the ROHC packet flow in the same order as the IR packet, replacing the original packet.

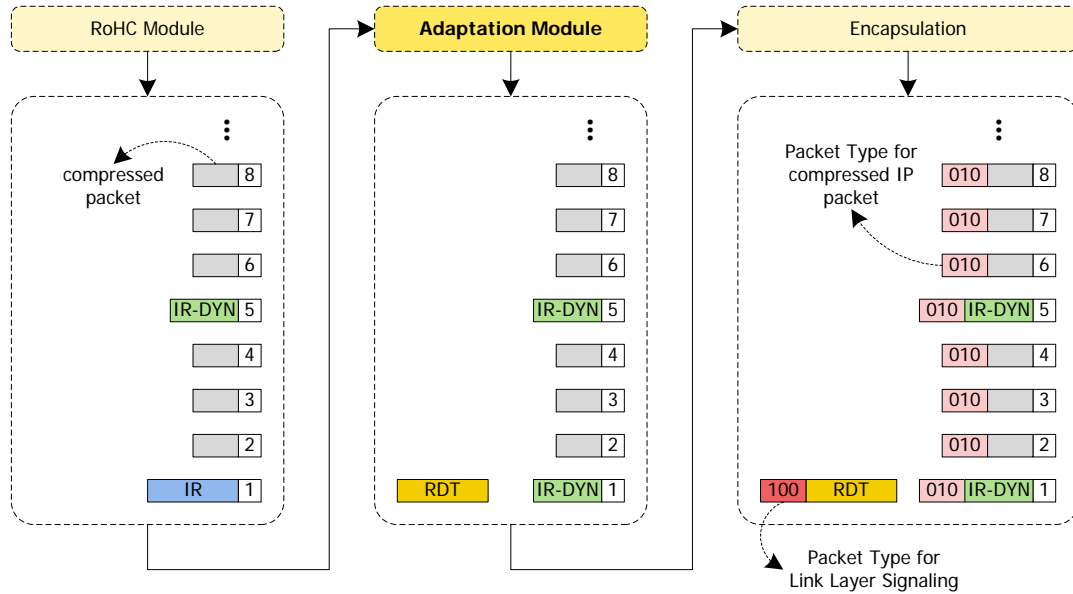

Figure 6.3 Procedure for IP header compression using adaptation mode 2.

Signaling (Context) information shall be encapsulated based on the transmission structure. Context information shall be configured as a part of the RDT and encapsulated within the link layer signaling as described in Section 5.2. In this case, the packet type value in the ALP packet carrying the link layer signaling shall be set to ‘100’.

6.2.1.3 Adaptation Mode 3

Figure 6.4 shows the procedure for context extraction when the transmitter side operates in adaptation mode 3. In adaptation mode 3, the adaptation module shall detect the IR and IR-DYN packet from the ROHC packet flow and shall extract the context information. The static chain and dynamic chain should be extracted from the IR packet and the dynamic chain should be extracted from the IR-DYN packet. After extracting the context information, each IR and IR-DYN packet shall be converted to a compressed packet. The compressed packet format shall be the same with the next packet of IR or IR-DYN packet. The converted compressed packet shall be included and transmitted inside the ROHC packet flow in the same order as the IR or IR-DYN packet, replacing the original packet.

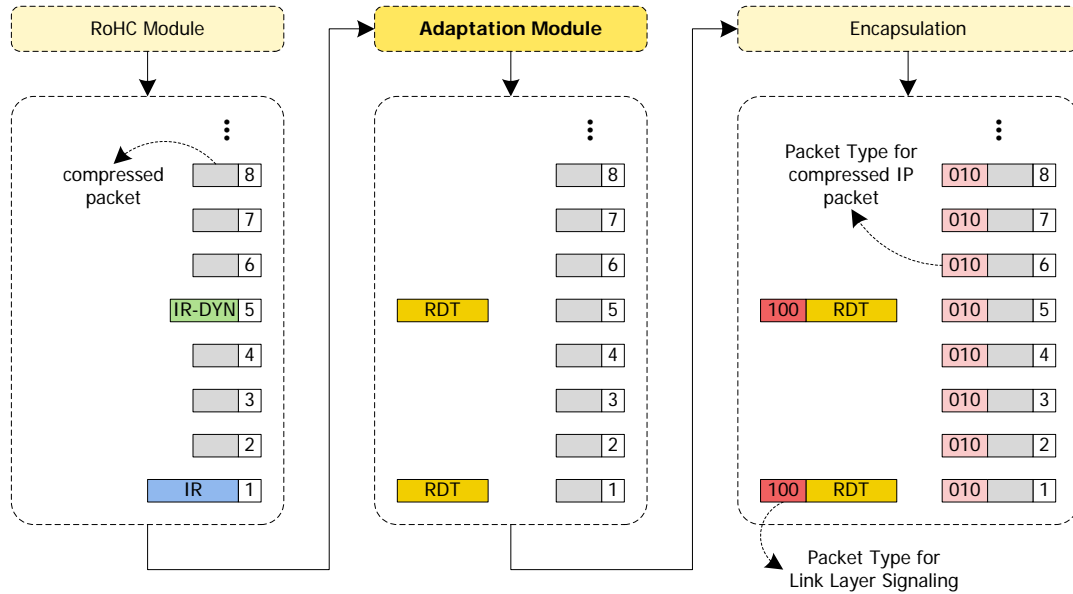

Figure 6.4 Procedure for IP header compression using adaptation mode 3.

Signaling (Context) information shall be encapsulated based on the transmission structure. Context information shall be configured as a part of the RDT and encapsulated to the link layer signaling as described in Section 5.2. In this case, the packet type value in ALP packet carrying the link layer signaling shall be set to ‘100’.

6.2.2 Transmission of Context

Figure 6.5 shows the transmission method of context separately from the compressed packet stream. The RDT, including extracted context information, should be transmitted separately from the ROHC packet flow, with signaling data through a specific physical data path. The transmission of the RDT depends on the configuration of the physical layer path. The RDT shall be transmitted when the context information is changed. In addition, the RDT shall be transmitted every physical layer frame. The RDT should be sent with other link layer signaling through the signaling PLP.

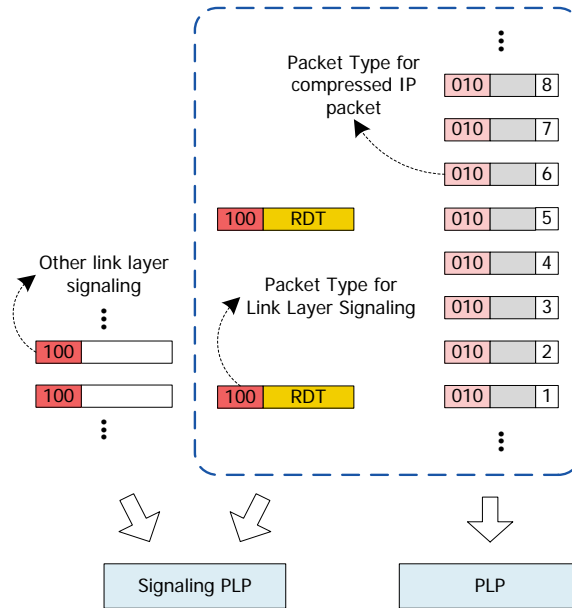

Figure 6.5 Transmission of context information.

The context acquisition procedure in the receiver side is described in Figure 6.6. Before the reception of the packet stream, the receiver shall acquire the signaling information including the SLT, LMT and RDT. When the receiver decodes the initial PLP to acquire the signaling information, the context signaling can be also received. After signaling acquisition is complete, the PLP carrying the packet stream can be selected. In the Figure 6.6, steps 1–3 can be considered to be the default operation in a broadcast receiver. From steps 1–3, the context information is acquired before starting packet stream reception.

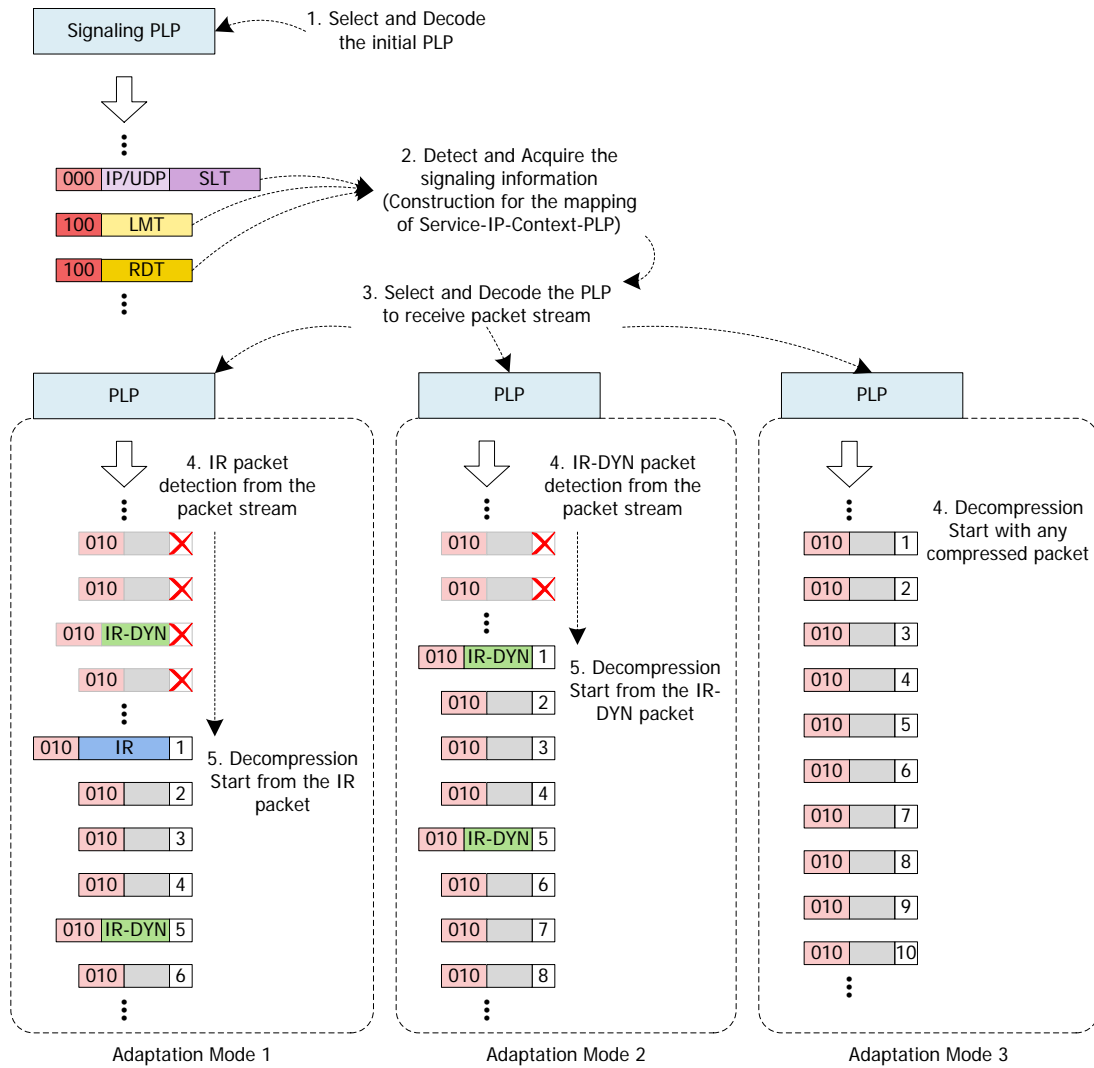

Figure 6.6 Context acquisition procedure in receiver side.

When the transmitter side operates in adaptation mode 1, the receiver must wait for the reception of the IR packet to start the decompression. Other packets which may be received prior to the first IR packet are not needed for decompression. The received ROHC packet flow is then sent to the ROHC decompressor.

When the transmitter side operates in adaptation mode 2, the receiver must wait for the reception of the IR-DYN packet to start the decompression. Other packets which may be received prior to the first IR-DYN packet are not needed for decompression. The adaptation module should parse the context information from the signaling data. Then, the adaptation module combines the context information (static chain) and the IR-DYN packets to form the ROHC packet flow. This operation is similar to receiving the IR packet. For the same context identifier, the IR-DYN packet is recovered to form the IR packet from the context information. The recovered ROHC packet flow is then sent to the ROHC decompressor.

When the transmitter side operates in adaptation mode 3, the receiver need not wait for any specific packet for decompression. In this case, the adaptation module combines the context

information and the compressed packets to form the ROHC packet flow. This operation is similar to receiving the IR packet. For the same context identifier, the compressed packet is recovered to form the IR/IR-DYN packet from the context information. The recovered ROHC packet flow is then sent to the ROHC decompressor.

7. LINK LAYER SIGNALING

Generally, link layer signaling operates below the IP layer. In the receiver, the link layer signaling can be obtained earlier than the IP-level signaling such as Low Level Signaling (LLS), including the Service List Table (SLT) and Service Layer Signaling (SLS). Therefore, the link layer signaling can be obtained before upper-layer signaling is received.

The link layer signaling shall be encapsulated into ALP packets as described in Section 5.2. Each signaling table shall be the payload of an ALP packet. The link layer signaling can be transmitted in various formats, including binary and XML. All link layer signaling tables shall be transmitted in the same format.

7.1 Table Format for Link Layer Signaling

7.1.1 Link Mapping Table (LMT)

The Link Mapping Table (LMT) provides a list of multicasts carried in a PLP. The LMT also provides additional information for processing the ALP packets carrying the multicasts in the link layer.

An LMT shall be present in any PLP identified as carrying LLS, as indicated by the value of the `L1D_plp_lls_flag` (see A/322 [1] Section 9.3.4) being set to '1'. Each instance of the LMT shall describe mappings between PLPs and IP addresses/ports for any IP address/port associated with any Service referenced in the Service List Table (see A/331 [2] Section 6.3) carried in the identified PLP carrying the LLS tables.

The LMT, when present in a PLP, shall be repeated at a rate of at least once every 5 seconds. When present, the LMT should be broadcast at the same rate as the SLT.

A link mapping example between upper layer and physical layer is shown in Figure 7.1. The LMT only provides information on UDP/IPv4 sessions.

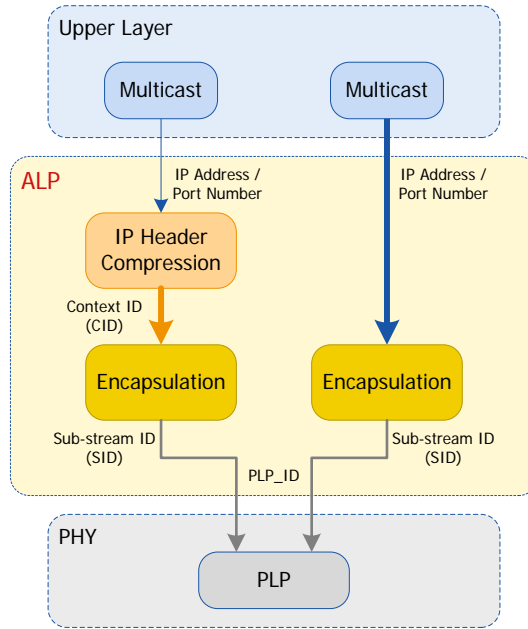

Figure 7.1 Example of Link Mapping for a PLP.

The values for Additional Header shall be as given in Table 7.1. The syntax for the LMT shall be as given in Table 7.2.

Table 7.1 Additional Header Values for LMT

Fields in Additional Header for Signaling	No. of bits	Value
signaling_type	8	0x01
signaling_type_extension	16	0xFFFF
signaling_format	2	00
signaling_encoding	2	00

Table 7.2 Syntax for Link Mapping Table

Syntax	No. of bits	Format
link_mapping_table() {		
num_PLPs_minus1	6	uimsbf
reserved	2	'11'
for (i=0; i<=num_PLPs_minus1; i++) {		
PLP_ID	6	uimsbf
reserved	2	'11'
num_multicasts	8	uimsbf
for (j=0; j<num_multicasts; j++) {		
src_IP_add	32	uimsbf
dst_IP_add	32	uimsbf
src_UDP_port	16	uimsbf
dst_UDP_port	16	uimsbf
SID_flag	1	bslbf
compressed_flag	1	bslbf
reserved	6	'111111'
if (SID_flag == 1) {		
SID	8	uimsbf
}		
if (compressed_flag == 1) {		
context_id	8	uimsbf
}		
}		
}		
}		

num_PLPs_minus1 – This 6-bit field shall have a value one less than the number of PLPs for which multicast-to-PLP mapping is provided in this table.

PLP_ID – This 6-bit field shall indicate the PLP corresponding to the multicast(s) signaled in this iteration of the “for” loop.

num_multicasts – This 8-bit unsigned integer field shall provide the number of multicasts carried in the PLP identified by the above PLP_ID field.

src_IP_add – This 32-bit unsigned integer field shall contain the source IPv4 address of the multicast signaled in this iteration of the “for” loop, carried in the PLP identified by the PLP_ID field.

dst_IP_add – This 32-bit unsigned integer field shall contain the destination IPv4 address of the multicast signaled in this iteration of the “for” loop, carried in the PLP identified by the PLP_ID field.

src_UDP_port – This 16-bit unsigned integer field shall represent the source UDP port number of the multicast signaled in this iteration of the “for” loop, carried in the PLP identified by the PLP_ID field.

dst_UDP_port – This 16-bit unsigned integer field shall represent the destination UDP port number of the multicast signaled in this iteration of the “for” loop, carried in the PLP identified by the PLP_ID field.

SID_flag – This 1-bit Boolean field shall indicate whether the ALP packet carrying the multicast identified by the above four fields, *src_ip_add*, *dst_ip_add*, *src_udp_port* and *dst_udp_port*, has an SID

field in its optional header. When the value of this field is set to '0', the ALP packet carrying the multicast shall not have an SID field in its optional header. When the value of this field is set to '1', the ALP packet carrying the multicast shall have an SID field in its optional header and the value the SID field shall be same as the following SID field in this table.

compressed_flag – This 1-bit Boolean field shall indicate whether the header compression is applied to the ALP packets carrying the multicast identified by the four fields above, `src_ip_add`, `dst_ip_add`, `src_udp_port` and `dst_udp_port`. When the value of this field is set to '0', the ALP packet carrying the multicast shall have a value of '0x00' of `packet_type` field in its Base Header. When the value of this field is set to 1, the ALP packet carrying the multicast shall have a value of '0x02' in the `packet_type` field in its Base Header and the `context_id` field shall be present. When the value of `compressed_flag` is equal to 1, there shall be an RDT signaled that has `PLP_ID` value equal to the `PLP_ID` value in this table for this session.

SID – This 8-bit unsigned integer field shall indicate a sub-stream identifier for the ALP packets carrying the multicast identified by the above four fields, `src_ip_add`, `dst_ip_add`, `src_udp_port` and `dst_udp_port`. This field shall be present only when the value of `SID_flag` is equal to '1'.

context_id – This 8-bit unsigned integer field shall provide a reference for the context id (CID) provided in the ROHC-U description table as specified in Section 7.1.2 with the value of the `PLP_ID` field in the RDT equal to the value of `PLP_ID` in this table. This field shall be present only when the value of `compressed_flag` is equal to '1'.

7.1.2 ROHC-U Description Table (RDT)

As described in Section 6, the ROHC-U adaptation module generates the signaling including the static chain and some necessary information for header compression. The values for the Additional Header shall be as given in Table 7.3. Table 7.4 describes the syntax of the RDT.

Table 7.3 Additional Header Values for RDT

Fields in Additional Header for Signaling	No. of bits	Value
<code>signaling_type</code>	8	0x02
<code>signaling_type_extension</code>	16	0xFFFF
<code>signaling_format</code>	2	00
<code>signaling_encoding</code>	2	00

Table 7.4 Syntax of ROHC-U Description Table

Syntax	No. of bits	Format
ROHC-U_description_table() {		
PLP_ID	6	uimsbf
max_CID	8	uimsbf
adaptation_mode	2	uimsbf
context_config	2	bslbf
reserved	6	'111111'
num_context	8	uimsbf
for (i=0; i<num_context; i++) {		
context_id	8	uimsbf
context_profile	8	uimsbf
if (context_config == 1) {		
context_length	8	uimsbf
static_chain_byte()	var	uimsbf
}		
else if (context_config == 2) {		
context_length	8	uimsbf
dynamic_chain_byte()	var	uimsbf
}		
else if (context_config == 3) {		
context_length	8	uimsbf
static_chain_byte()	var	uimsbf
dynamic_chain_byte()	var	uimsbf
}		
}		
}		

PLP_ID – This 6-bit field shall indicate the PLP corresponding to this table.

max_CID – This 8-bit field shall indicate the maximum value of context id to be used corresponding to this PLP.

adaptation_mode – This 2-bit field shall indicate the mode of the adaptation module in this PLP as described in Section 6.2.1. The code values of adaptation_mode field shall be as given in Table 7.5.

Table 7.5 Code Values for Adaptation Mode

adaptation_mode	Meaning
00	Adaptation Mode 1 (see Section 6.2.1.1)
01	Adaptation Mode 2 (see Section 6.2.1.2)
10	Adaptation Mode 3 (see Section 6.2.1.3)
11	Reserved

context_config – This 2-bit field shall indicate the combination of the context information. If there is no context information in this table, this field shall be set to '0'. If the static_chain_byte() or dynamic_chain_byte() is included in this table, this field shall be set to '1' or '2' respectively. If the static_chain_byte() and dynamic_chain_byte() are included in this table, this field shall be set to '3'.

num_context – This 8-bit field shall indicate the number of context in this table. The value of num_context shall not be larger than max_CID.

context_id – This 8-bit field shall indicate the context id (CID) of the compressed IP stream. In an ATSC 3.0 system, 8-bit CID shall be used for large CID. It shall be encoded as defined in clause 5.1.3 of RFC 3095 [7].

context_profile – This 8-bit field indicates the range of protocols used to compress the stream. It shall convey the eight least significant bits of the ROHC profile identifier defined in Section 6.1.

context_length – This 8-bit field indicates the length of the static chain byte sequence.

static_chain_byte() – This field conveys the static information used to initialize the ROHC-U decompressor. The size and structure of this field depend on the context profile. The static_chain_byte() is defined in Section 5.7.7.1 of RFC 3095 [7] as “Static chain” in the sub-header information of the IR packet.

dynamic_chain_byte() – This field conveys the dynamic information used to initialize the ROHC-U decompressor. The size and structure of this field depend on the context profile. The dynamic_chain_byte() is defined in Section 5.7.7.1 of RFC 3095 [7] as sub-header information of IR packet and IR-DYN packet.

Annex A: ALP Packet Format Examples

A.1 ALP PACKET ENCAPSULATION

A.1.1 Single Packet Encapsulation

Figure A.1.1 shows an example of single short packet encapsulation.

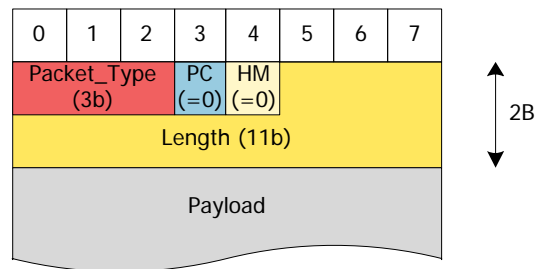

Figure A.1.1 Single Packet Encapsulation (short packet).

Figure A.1.2 shows an example of single long packet encapsulation. In this example, the SID and optional headers are not used.

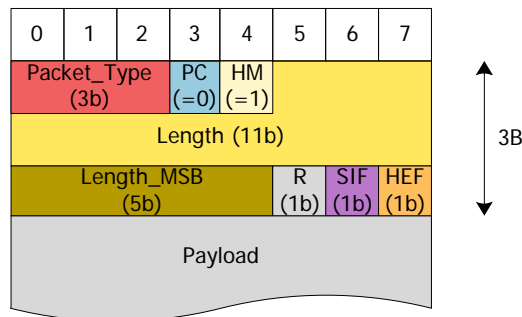

Figure A.1.2 Single Packet Encapsulation (long packet).

A.1.2 Segmentation

Figure A.1.3 shows an example where an IP packet is divided into segments, which are encapsulated in the link layer packets.

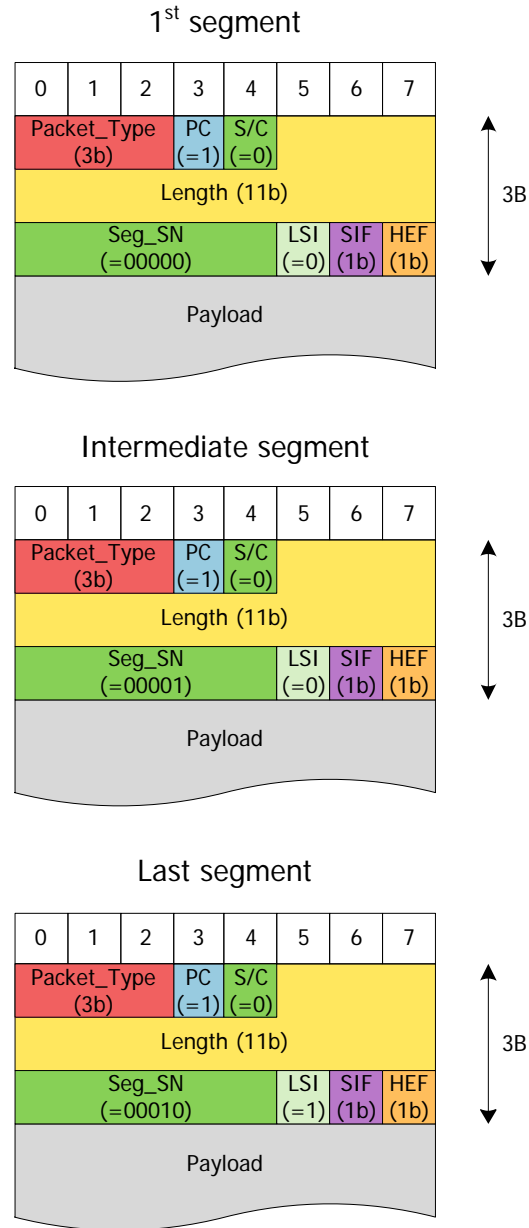

Figure A.1.3 Segmented Packet Encapsulation.

A.1.3 Concatenation

Figure A.1.4 shows an example where several IP packets are concatenated into one payload of the link layer packet. The component length fields ($L_1 \sim L_{n-1}$) indicate the length of each IP packets except the last one. The difference of length field and sum of all component length values indicates the last concatenated IP packet.

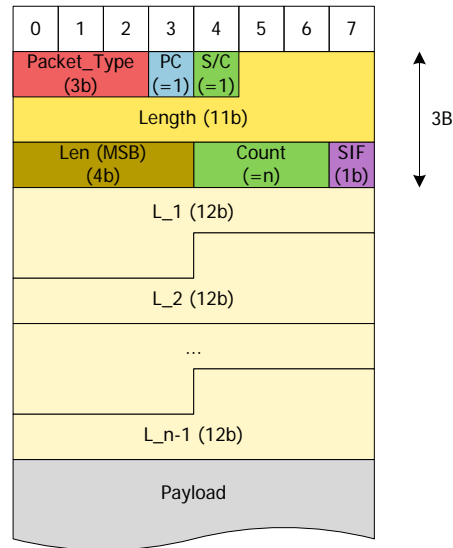

Figure A.1.4 Concatenated Packet Encapsulation.

When an ALP header consists of an odd number in component_length, four stuffing bits follow after the L_{n-1} field as shown in Figure A.1.5.

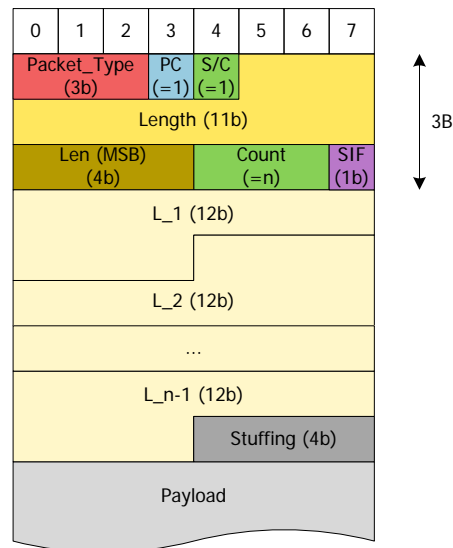

Figure A.1.5 Concatenated Packet Encapsulation (odd number of component_length field).

A.2 MPEG-2 TS PACKET ENCAPSULATION

An ALP packet can carry several MPEG-2 TS packets without sync bytes in their payloads. Figure A.2.1 shows an example of an ALP packet containing eight MPEG-2 TS packets. The encapsulation process can be described as follows:

- Remove sync bytes for MPEG-2 TS packets to be encapsulated (the length of MPEG-2 TS packets are reduced to 187 Bytes from 188 Bytes)
- Group 8 MPEG-2 TS packets into the payload of an ALP packet (the length of payload is $187 \times 8 = 1496$ Bytes)
- Generate an ALP header of length 1 Byte with the following values:
 - packet_type = '111'
 - NUMTS = '1000'
 - AHF = '0'

The resulting ALP packet can save seven bytes compared with the case when the eight MPEG-2 TS packets are directly fed into the PHY layer.

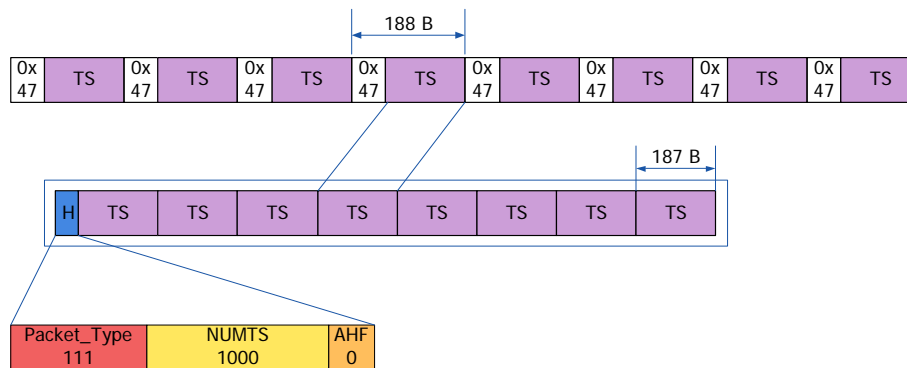

Figure A.2.1 MPEG-2 TS encapsulation example.

A.2.1 Using Null Packet deletion

ALP can delete null MPEG-2 TS packets prior to the first MPEG-2 TS packet encapsulated into an ALP packet and let the receiver know the number of deleted null MPEG-2 TS packets via the header of the ALP packet. Figure A.2.2 shows an example of an ALP packet containing six MPEG-2 TS packets when two null MPEG-2 TS packets are deleted prior to the first MPEG-2 TS packet in its payload. The encapsulation process can be described as follows:

- Delete Null Packets and count
- Remove sync bytes for MPEG-2 TS packets to be encapsulated (the length of the MPEG-2 TS packets are reduced to 187 Bytes from 188 Bytes)
- Group six MPEG-2 TS packets into the payload of an ALP packet (the length of payload is $187 \times 6 = 1122$ Bytes)
- Generate an ALP header of length 2 Bytes with the following values:
 - packet_type = '111'
 - NUMTS = '0110'
 - AHF = '1' (It indicates that there are deleted Null Packets prior to the first MPEG-2 TS packet encapsulated into its payload.)

- HDM = '0'
- DNP = '0000010'

The resulting ALP packet is of length 1124 Bytes and can save 380 bytes compared with the case when the 8 MPEG-TS packets are directly fed into the PHY layer.

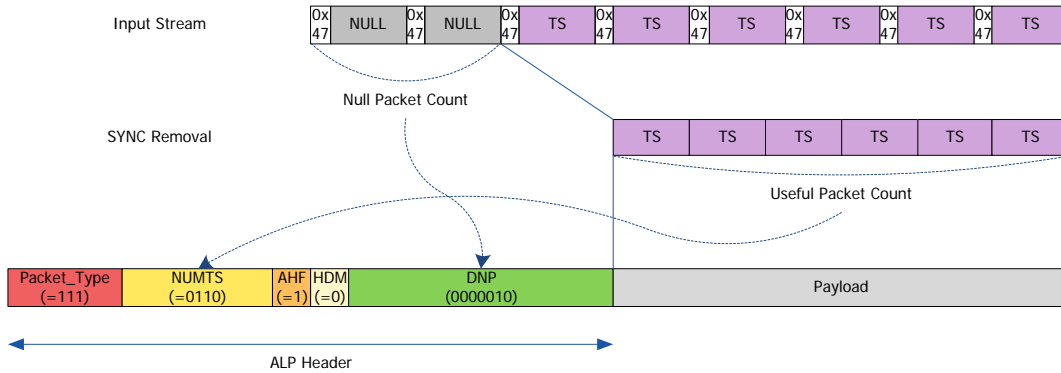

Figure A.2.2 MPEG-2 TS encapsulation example using Null Packet Deletion.

Figure A.2.3 shows an example of ALP packet decapsulation and Null Packet insertion. The decapsulation procedure at the receiver side can be described follow:

- Check the DNP field.
- Check the number of TS packet in this ALP packet using NUMTS field.
- Insert the sync byte.
- Generate the Null Packet as indicated in DNP field before the group of useful TS packets.

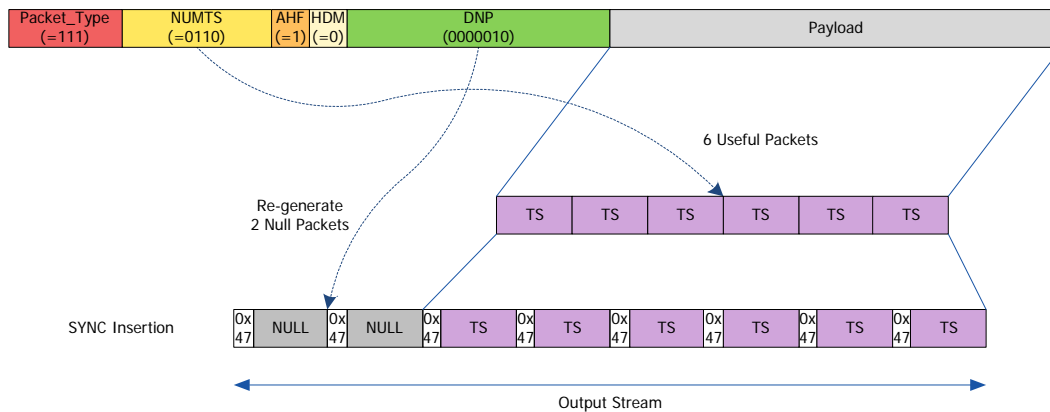

Figure A.2.3 MPEG-2 TS decapsulation example using Null Packet Deletion.

A.2.2 Using TS Header deletion

ALP can further compress the header of the MPEG-2 TS packet encapsulated into an ALP packet. Figure A.2.4 shows an example of an ALP packet containing eight MPEG-2 TS packets which have the same header excluding the CC (continuity counter) field. The encapsulation process can be described as follows:

- Group eight TS packets which have the same header excluding the CC field.

- The header (excluding sync byte) is kept only for the first MPEG2-TS packet and removed for the other seven MPEG-2 TS packets (the length of payload is $3 + 184 \times 8 = 1475$ Bytes).
- Generate an ALP header of length 2 Bytes with the following values:
 - Packet_Type = ‘111’
 - NUMTS = ‘0100’
 - AHF = ‘1’
 - HDM = ‘1’
 - DNP = ‘0000000’

The resulting ALP packet is of length 1477 Bytes and can save 27 bytes compared with the case when the 8 MPEG-TS packets are directly fed into the PHY layer.

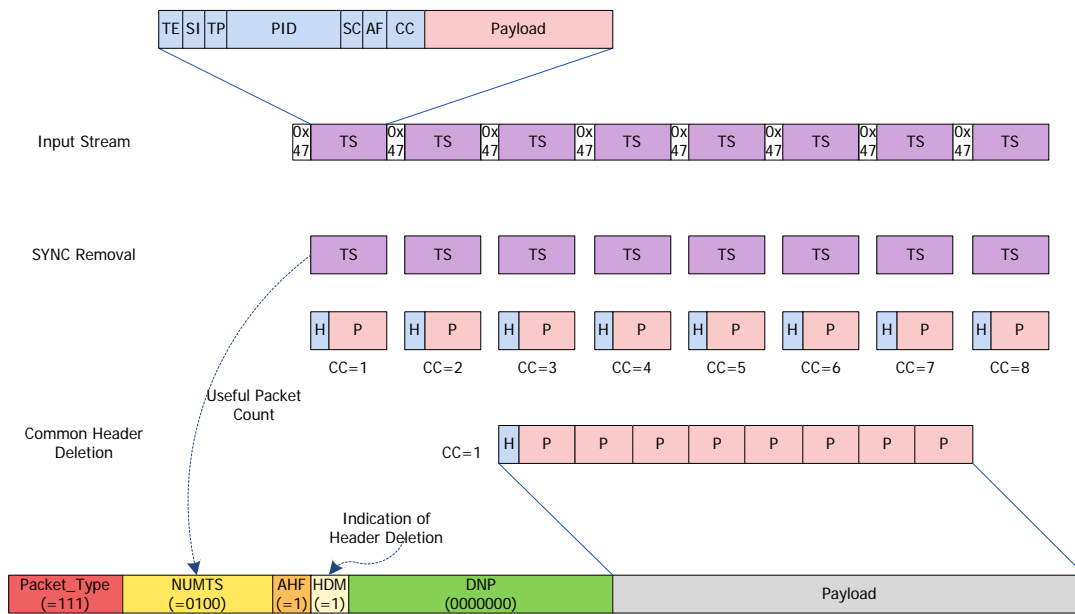

Figure A.2.4 MPEG-2 TS encapsulation example using TS header deletion.

Figure A.2.5 shows an example of ALP packet decapsulation and TS header recovery under the header deletion mode. The decapsulation procedure at the receiver side can be described as follows:

- Detect the header deletion mode reading HDM field
- Check the number of TS packet in this ALP packet using NUMTS field.
- The first TS packet includes a 3-byte header and 184-byte payload and the remaining TS packets have a 184-byte payload only.
- Generate all TS packet headers using the header of the first TS packet, at this time each successive CC field is increased by one.
- Insert the sync byte.

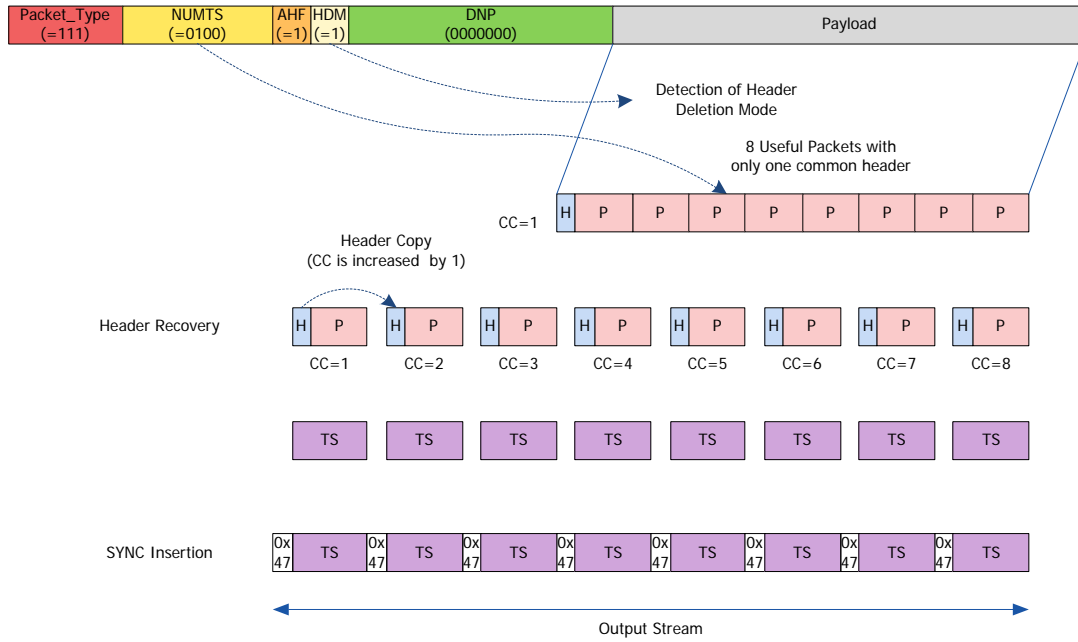

Figure A.2.5 MPEG-2 TS decapsulation example using TS header deletion.

Annex B: IP Header Compression Examples

B.1 USING ADAPTATION MODE 1

Figure B.1.1 shows an example of IP header compression when adaptation mode 1 is used.

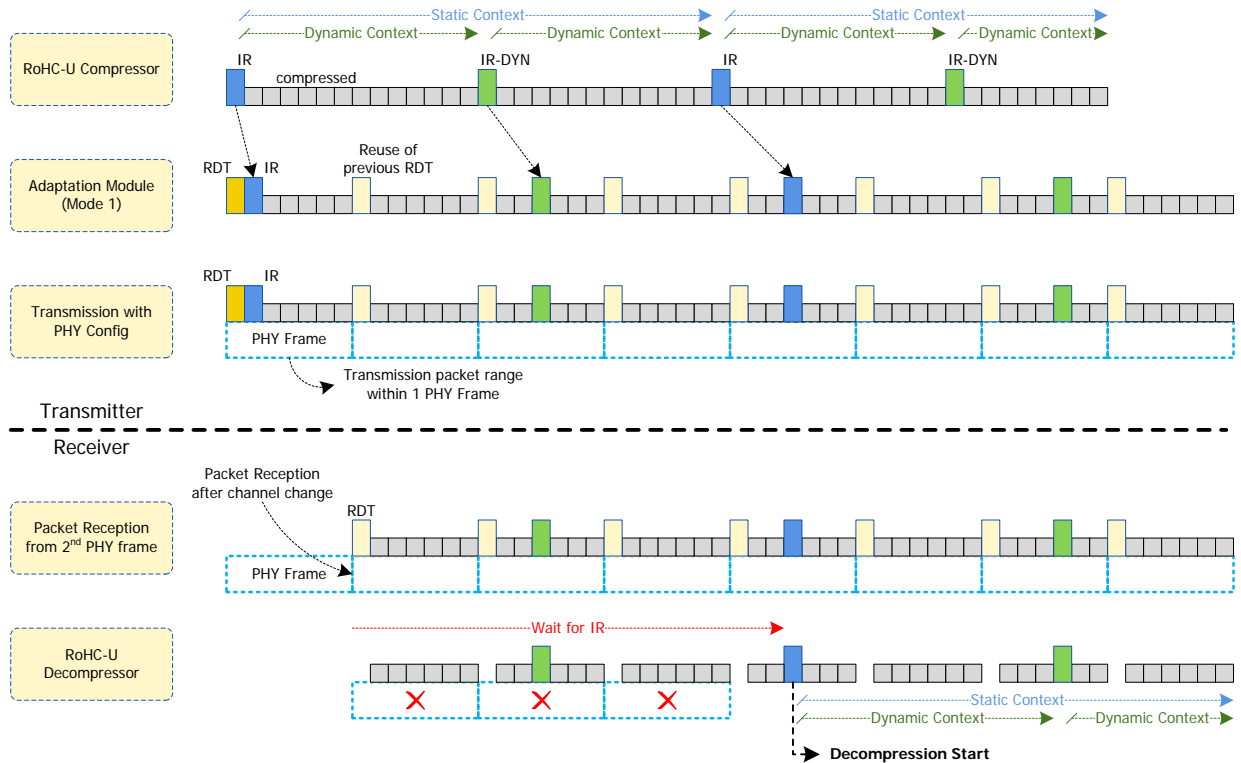

Figure B.1.1 Example of IP header compression using adaptation mode 1.

The operation in the transmitter is described below.

When the IP packet stream is transported into the ROHC-U Compressor, for the first input IP packet, the context is initialized and the IR packet is generated. When the context is updated, the IR-DYN packet is generated. Static context is kept until the next IR packet is generated. The dynamic context is kept until the next IR or IR-DYN packet is generated.

When adaptation mode 1 is used, there are no procedures for packet conversion and context extraction. In order to transmit the ROHC configuration parameters, an RDT is generated in the adaptation module.

In this example, the RDT is transmitted every physical frame. If there is no change in configuration parameters, in order to transmit the RDT for every physical frame, the previous RDT can be reused. Packets are transmitted according to the capacity of the physical layer frame.

The operation in the receiver is described below.

In this example, it is considered that the packet stream is received from a second physical frame. From the first RDT, ROHC configuration parameters are obtained. In adaptation mode 1, the packet stream (not including the RDT) is passed into the ROHC-U decompressor. Since the ROHC-U decompressor cannot recover the IP header without full context, the ROHC-U decompressor must wait for the reception of the IR packet. After reception of the IR packet, the decompression process is started.

B.2 USING ADAPTATION MODE 2

Figure B.2.1 shows an example of IP header compression when adaptation mode 2 is used.

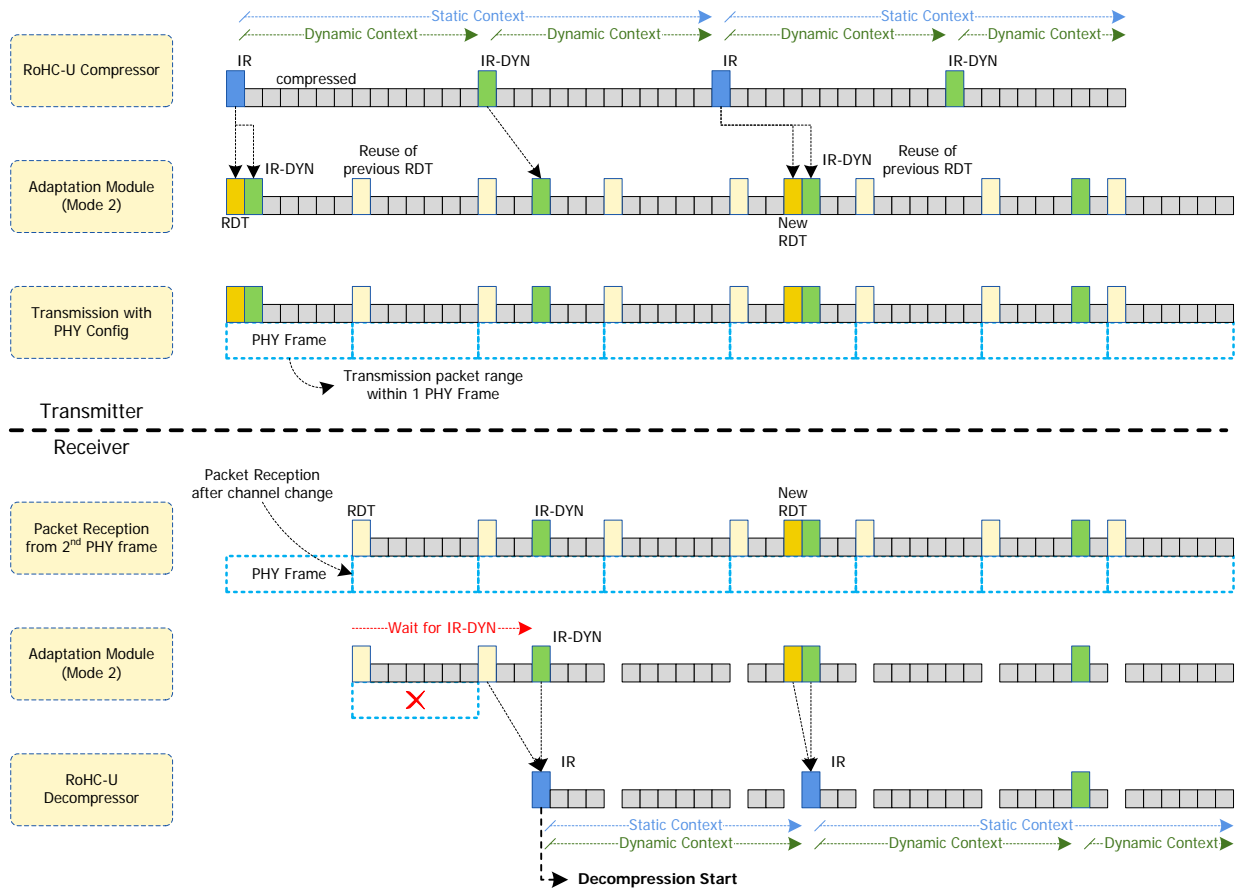

Figure B.2.1 Example of IP header compression using adaptation mode 2.

The operation in the transmitter is described below.

When the IP packet stream is transported into the ROHC-U Compressor, for the first input IP packet, the context is initialized and the IR packet is generated. When the context is updated, the IR-DYN packet is generated. Static context is kept until the next IR packet is generated. The dynamic context is kept until the next IR or IR-DYN packet is generated.

When adaptation mode 2 is used, the adaptation module extracts the static context information from the IR packet. After extracting the context information, each IR packet is converted to an IR-DYN packet. Context information is configured as a part of the RDT with ROHC configuration parameters.

In this example, the RDT is transmitted every physical frame. If there is no change of static context information and configuration parameters, in order to transmit the RDT for every physical frame, the previous RDT can be reused. Packets are transmitted according to the capacity of the physical layer frame.

The operation in the receiver is described below.

In this example, it is considered that the packet stream is received from a second physical frame. From the first RDT, the static context information and ROHC configuration parameters can be obtained. In adaptation mode 2, the IR packet is recovered using the IR-DYN packet and the static context. Therefore, the adaptation module must wait for the reception of the IR-DYN packet. When the RDT is updated, the adaptation module recovers the IR packet.

The packet stream is passed into the ROHC-U decompressor after the IR packet recovery. The decompression process is started from the IR packet in the ROHC-U decompressor.

B.3 USING ADAPTATION MODE 3

Figure B.3.1 shows an example of IP header compression when the adaptation mode 3 is used.

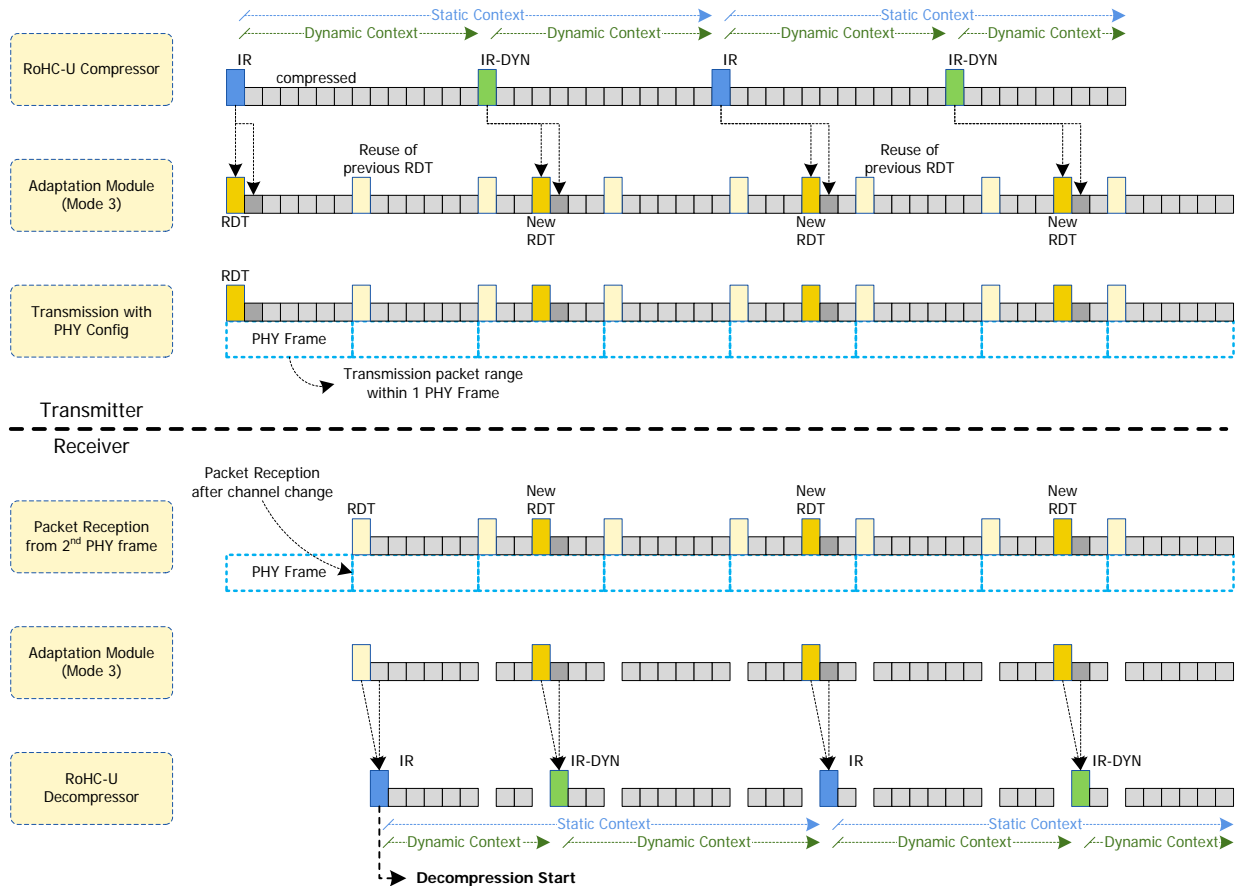

Figure B.3.1 Example of IP header compression using adaptation mode 3.

The operation in the transmitter is described below.

When the IP packet stream is transported into the ROHC-U Compressor, for the first input IP packet, the context is initialized and the IR packet is generated. When the context is updated, the

IR-DYN packet is generated. Static context is kept until the next IR packet is generated. The dynamic context is kept until the next IR or IR-DYN packet is generated.

When adaptation mode 3 is used, the adaptation module extracts the static context and dynamic context information from the IR packet and the IR-DYN respectively. After extracting the context information, each IR and IR-DYN packet is converted to a compressed packet. Context information is configured as a part of the RDT with ROHC configuration parameters.

In this example, the RDT is transmitted every physical frame. If there is no change of context information and configuration parameter, in order to transmit the RDT for every physical frame, the previous RDT can be reused. Packets are transmitted according to the capacity of the physical layer frame.

The operation in the receiver is described below.

In this example, it is considered that the packet stream is received from a second physical frame. From the first RDT, the static/dynamic context information and ROHC configuration parameters can be obtained. In adaptation mode 3, the IR packet is recovered using any compressed packet with context information of the RDT. When the RDT is updated, the adaptation module recovers the IR or IR-DYN packet.

The packet stream is passed into the ROHC-U decompressor after IR packet recovery. The decompression process is started from the IR packet in the ROHC-U decompressor.

— End of Document —