



The Broadcast[®]
Standards
Association



ATSC Standard: Physical Layer Protocol

A/322:2026-04
14 April 2026

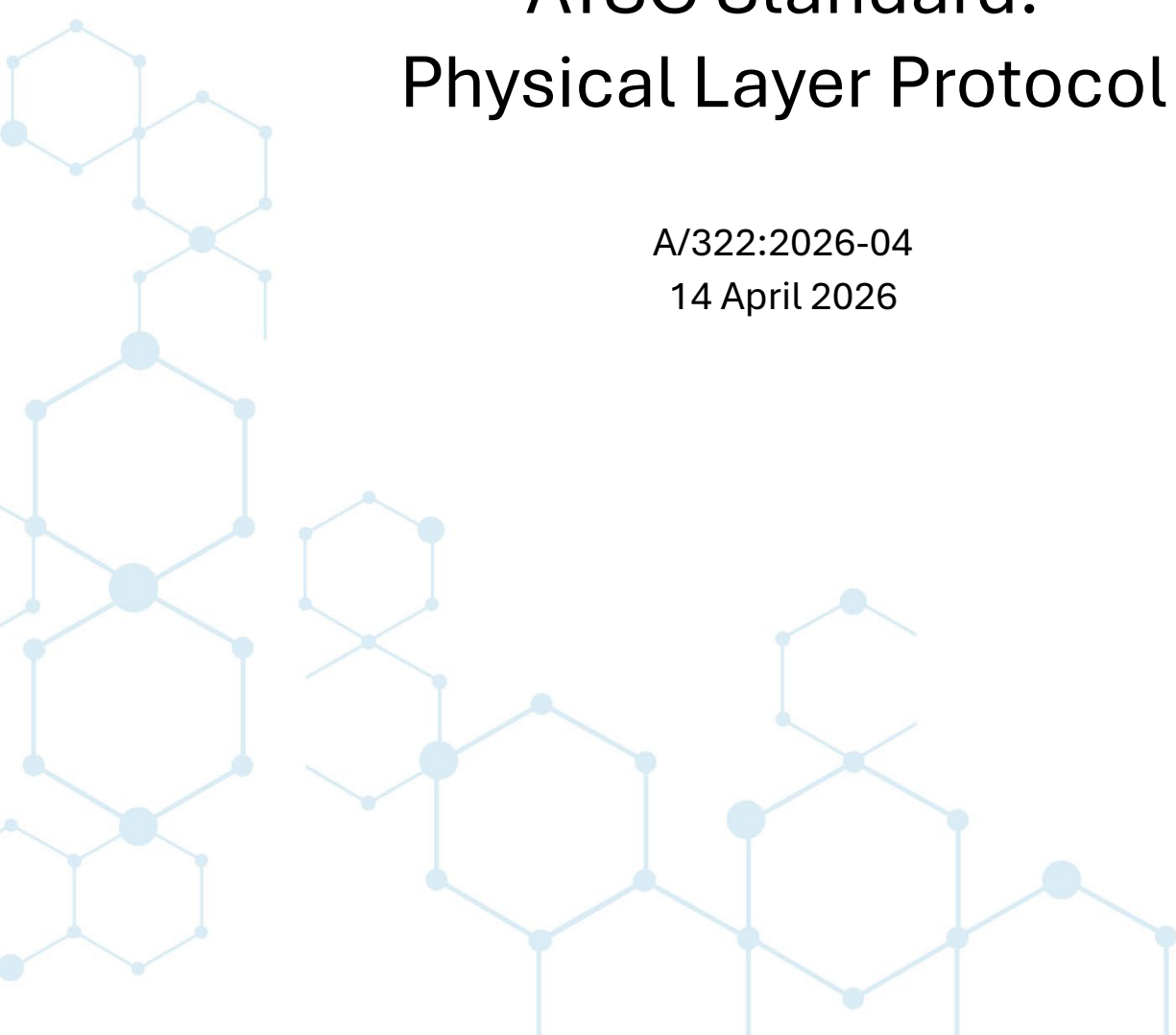

ATSC[®], the Broadcast Standards Association[®], is an international, non-profit organization developing voluntary standards and recommended practices for broadcast television and multimedia data distribution. ATSC member organizations represent the broadcast, professional equipment, motion picture, consumer electronics, computer, cable, satellite, and semiconductor industries. ATSC also develops implementation strategies and supports educational activities on ATSC standards. ATSC was formed in 1983 by the member organizations of the Joint Committee on Inter-society Coordination (JCIC): the Consumer Technology Association (CTA), the Institute of Electrical and Electronics Engineers (IEEE), the National Association of Broadcasters (NAB), the Internet & Television Association (NCTA), and the Society of Motion Picture and Television Engineers (SMPTE). For more information visit www.atsc.org.

© Copyright 2026 ATSC. All rights reserved.

Note: The user’s attention is called to the possibility that compliance with this standard may require use of an invention covered by patent rights. By publication of this standard, no position is taken with respect to the validity of this claim or of any patent rights in connection therewith. One or more patent holders have, however, filed a statement regarding the terms on which such patent holder(s) may be willing to grant a license under these rights to individuals or entities desiring to obtain such a license. Details may be obtained from the ATSC Secretary and the patent holder.

Implementers with feedback, comments, or potential bug reports relating to this document may contact ATSC at <https://www.atsc.org/feedback/>.

Disclaimer

Not all optional settings that are combinations with non-optional settings have been tested at the time of release of this document.

Revision History

Version	Date
A/322:2016 approved	7 September 2016
A/322:2017 approved	9 February 2017
Amendment No. 1 to A/322:2017 approved as a roll-up	6 June 2017
A/322:2018 approved	26 December 2018
A/322:2020 approved	23 January 2020
A/322:2021 approved	20 January 2021
A/322:2022-03 (references to ATSC documents updated)	31 March 2022
Amendment No. 1 to A/322:2022-03 approved	24 November 2022
A/322:2022-11 (includes Amendment No. 1 to A/322:2022-03)	24 November 2022
A/322:2023-03 (references to ATSC documents updated)	28 March 2023
Capitalization of “Time Information Position” in Figure 9.1 outline corrected	9 August 2023
Broken reference link fixed on page 263	27 September 2023
A/322:2024-04 (references to ATSC documents updated)	3 April 2024
Amendment No. 1 to A/322:2024-04 approved	13 September 2024
A/322:2024-09 (includes Amendment No. 1 to A/322:2024-04)	13 September 2024
Amendment No. 1 to A/322:2024-09 approved	28 July 2025

A/322:2025-07 (references to ATSC documents updated)	17 July 2025
A/322:2025-07a (includes Amendment No. 1 to A/322:2024-09)	28 July 2025
Amendment No. 1 to A/322:2025:07a approved	26 January 2026
A/322:2026-01 (includes Amendment No. 1 to A/322:2025-07a)	26 January 2026
A/322:2026-04 (references to ATSC documents updated)	14 April 2026

Table of Contents

1.	SCOPE	1
	1.1 Introduction and Background	1
	1.2 Organization	1
2.	REFERENCES	2
	2.1 Normative References	2
3.	DEFINITION OF TERMS	2
	3.1 Compliance Notation	2
	3.2 Treatment of Syntactic Elements	3
	3.2.1 Reserved Elements	3
	3.3 Acronyms, Abbreviations and Mathematical Operators	3
	3.4 Terms	5
4.	SYSTEM OVERVIEW	7
	4.1 Features	7
	4.2 System Architecture	8
	4.3 Central Concepts	10
5.	INPUT FORMATTING	11
	5.1 Encapsulation and Compression	11
	5.1.1 Number of PLPs	12
	5.2 Baseband Formatting	12
	5.2.1 Mapping ALP Packets to Baseband Packets	12
	5.2.2 Baseband Packet Header	13
	5.2.3 Scrambling of Baseband Packets	17
6.	BIT-INTERLEAVED CODED MODULATION (BICM)	18
	6.1 Forward Error Correction (FEC)	18
	6.1.1 FEC Frame Structure	18
	6.1.2 Outer Encoding	20
	6.1.3 Inner Encoding	22
	6.2 Bit Interleavers	25
	6.2.1 Parity Interleaver	25
	6.2.2 Group-Wise Interleaver	25
	6.2.3 Block Interleavers	26
	6.3 Constellation Mapping	30
	6.3.1 Constellation Overview	31
	6.3.2 Modulation and Coding Combinations	31
	6.3.3 Demultiplexing Operation	32
	6.3.4 Bit to IQ Mapping	33
	6.4 Layered Division Multiplexing (LDM)	35
	6.4.1 LDM Encoding	35
	6.4.2 Injection Level Controller	36
	6.4.3 Power Normalizer	37
	6.4.4 LDM Example	38
	6.5 Protection for L1 Signaling	39
	6.5.1 Overview	39

6.5.2	Common Blocks for L1-Basic and L1-Detail	40
6.5.3	L1-Detail Specific Block Details	50
7.	FRAMING AND INTERLEAVING	55
7.1	Time Interleaving	55
7.1.1	Time Interleaver Modes	55
7.1.2	Time Interleaver Size	56
7.1.3	Extended Interleaving	56
7.1.4	Convolutional Time Interleaver (CTI) Mode	57
7.1.5	Hybrid Time Interleaver (HTI) Mode	58
7.2	Framing	67
7.2.1	Overview	67
7.2.2	Frame Structure	67
7.2.3	Number of Carriers	69
7.2.4	Frame Symbol Types	69
7.2.5	Preamble	70
7.2.6	Cell Multiplexing	72
7.2.7	PLP Multiplexing Approaches within a Subframe	81
7.3	Frequency Interleaving	90
8.	WAVEFORM GENERATION	94
8.1	Pilot Insertion	95
8.1.1	Introduction	95
8.1.2	Reference Sequence	95
8.1.3	Scattered Pilot Insertion	96
8.1.4	Continual Pilot Insertion	97
8.1.5	Edge Pilot Insertion	99
8.1.6	Preamble Pilot Insertion	99
8.1.7	Subframe Boundary Pilot Insertion	101
8.2	MISO	101
8.2.1	Transmit Diversity Code Filter Sets	101
8.3	Inverse Fast Fourier Transform (IFFT)	102
8.4	Peak to Average Power Ratio Reduction Techniques	105
8.4.1	Tone Reservation	105
8.4.2	Active Constellation Extension (ACE)	106
8.5	Guard Interval	106
8.5.1	Guard Interval Extension for Time-aligned Frames	106
8.6	Bootstrap	108
9.	L1 SIGNALING	108
9.1	Bootstrap	108
9.1.1	Versioning	108
9.1.2	Bootstrap Symbol 1	108
9.1.3	Bootstrap Symbol 2	109
9.1.4	Bootstrap Symbol 3	109
9.2	Syntax for L1-Basic Data	109
9.2.1	L1-Basic System and Frame Parameters	110
9.2.2	L1-Basic Parameters for L1-Detail	112
9.2.3	L1-Basic Parameters for First Subframe	113

9.2.4	L1-Basic Miscellaneous Parameters	115
9.3	Syntax and Semantics for L1-Detail Data	115
9.3.1	L1-Detail Miscellaneous Parameters	118
9.3.2	L1-Detail Channel Bonding Parameters (Frame)	119
9.3.3	L1-Detail Subframe Parameters	120
9.3.4	L1-Detail PLP Parameters	124
9.3.5	L1-Detail LDM Parameters	126
9.3.6	L1-Detail Channel Bonding Parameters (PLP)	127
9.3.7	L1-Detail MIMO Parameters (PLP)	128
9.3.8	L1-Detail Cell Multiplexing Parameters	128
9.3.9	L1-Detail Time Interleaver (TI) Parameters	129
ANNEX A	: LDPC CODES	132
A.1	LDPC Code Matrices ($N_{inner} = 64800$)	132
A.2	LDPC Code Matrices ($N_{inner} = 16200$)	144
ANNEX B	: BIT INTERLEAVER SEQUENCES	149
B.1	Permutation sequences of group-wise interleaving for $N_{inner} = 64800$ ($N_{group} = 180$)	149
B.2	Permutation sequences of group-wise interleaving for $N_{inner} = 16200$ ($N_{group} = 45$)	162
ANNEX C	: CONSTELLATION DEFINITIONS AND FIGURES	166
C.1	Constellation Definitions	166
C.2	Constellation Figures	173
C.3	Constellation Labeling	177
ANNEX D	: CONTINUAL PILOT (CP) PATTERNS	180
D.1	Reference and Additional CP Indices	180
ANNEX E	: SCATTERED PILOT (SP) PATTERNS	184
E.1	SISO Scattered Pilot Patterns	184
ANNEX F	: NUMBER OF ACTIVE DATA CELLS IN SUBFRAME BOUNDARY SYMBOL	189
F.1	Subframe Boundary Symbol Active Data Cell Tables	189
F.2	Calculation of Subframe Boundary Symbol Null Cells (Informative)	194
ANNEX G	: TONE RESERVATION CARRIER INDICES	195
G.1	Tone Reservation Carrier Indices	195
ANNEX H	: PREAMBLE PARAMETERS FOR BOOTSTRAP	198
H.1	Preamble Structure Parameter Values	198
ANNEX I	: TOTAL SYMBOL POWER	202
I.1	Preamble Symbol Frequency Domain Power	202
I.2	Data and Subframe Boundary Symbol Frequency Domain Power	203
ANNEX J	: MISO	209
J.1	MISO Frequency Domain Coefficients	209
ANNEX K	: CHANNEL BONDING	214
K.1	Introduction	214
K.2	Plain Channel Bonding	215
K.3	Channel Bonding with SNR Averaging	216
K.4	Cell/PLP Multiplexing	217
ANNEX L	: MIMO	219
L.1	Overview	219

L.2	FEC Coding	220
L.3	Bit Interleaving	220
L.4	MIMO Mapping	221
L.4.1	Demultiplexer	221
L.4.2	Constellations	221
L.5	Precoding	221
L.5.1	Stream Combining	222
L.5.2	I/Q Polarization Interleaving	223
L.5.3	Phase Hopping	223
L.6	Time Interleaver	224
L.7	Framer	224
L.8	Frequency Interleaving	225
L.9	Pilot Patterns	225
L.9.1	Pilot Polarization Encoding	225
L.9.2	Pilot Schemes	227
L.10	MISO	237
L.11	IFFT	237
L.11.1	Case 1: Pure MIMO Frame	238
L.11.2	Case 2: Coexistence with SISO Subframes	239
L.12	PAPR Reduction	239
L.13	Channel Bonding	239
L.14	L1 signalling for MIMO	241
ANNEX M : EXAMPLE OF PEAK TO AVERAGE POWER RATIO REDUCTION ALGORITHMS		242
M.1	PAPR Reduction Algorithms	242
M.2	TR Algorithm	242
M.3	ACE Algorithms	244
M.3.1	1-D ACE algorithm	244
M.3.2	2-D ACE Algorithm	246
M.3.3	2-D ACE Constellation Diagrams	248
ANNEX N : TRANSMITTER IDENTIFICATION (TXID)		252
N.1	Overview	252
N.2	Code Generation	252
N.2.1	Multiple Shift Registers	253
N.2.2	Clock Rate	254
N.2.3	Preloaded Values	254
N.2.4	Synchronization with Preamble Symbol	254
N.3	Code Transmission	255
N.3.1	BPSK Modulation	255
N.3.2	TxID Injection Level	255
N.4	Signaling Fields	256
N.5	MIMO	256
ANNEX O : COMBINATION OF LDM AND MIMO		257
O.1	Oveview	257
O.2	FEC coding	259
O.3	Bit Interleaving	259

O.4	Constellation Mapping	259
O.5	Precoding	259
O.6	LDM Combining: Constellation Superposition for LDM	259
O.6.1	Constellation Superposition for Layered MIMO Type A	260
O.6.2	Constellation Superposition for Layered MIMO Type B	260
O.7	Time Interleaver	261
O.8	Framing	262
O.9	Frequency Interleaving	263
O.10	Pilot Patterns	263
O.10.1	Pilot Polarization Encoding	263
O.10.2	Pilot Schemes	263
O.11	MISO	263
O.12	IFFT	263
O.12.1	Coexistence with SISO or MIMO Subframes	265
O.13	Channel Bonding	266
O.14	L1 Signalling for Layered MIMO	268

Index of Figures

Figure 4.1 Block diagram of the system architecture for one RF channel.	8
Figure 4.2 Block diagram (simplified) of a single PLP system architecture.	9
Figure 4.3 Block diagram (simplified) of a multiple PLP system architecture.	9
Figure 4.4 Block diagram (simplified) of the LDM system architecture.	10
Figure 4.5 Block diagram (simplified) of a channel bonded system.	10
Figure 5.1 Block diagram of input formatting.	11
Figure 5.2 Block diagram of baseband formatting.	12
Figure 5.3 Baseband Packet structure showing Header, Payload and mapping example of ALP packets to a Baseband Packet.	13
Figure 5.4 Baseband Packet Header structure details.	14
Figure 5.5 Structure of Extension Field for the Mixed Extension Mode.	16
Figure 5.6 Shift register of the PRBS encoder for baseband scrambling.	18
Figure 6.1 Block diagram of BICM.	18
Figure 6.2 Structure of FEC Frame when BCH or CRC is used as Outer Code.	19
Figure 6.3 Structure of FEC Frame when no Outer Code is used.	19
Figure 6.4 Shift register for CRC-32.	21
Figure 6.5 Bit interleaver structure.	25
Figure 6.6 Parity interleaved LDPC codeword bit groups.	26
Figure 6.7 Write/Read operation of Type A block interleaving.	29
Figure 6.8 Write operation of Part 1 Type B block interleaving for 256QAM.	30
Figure 6.9 Read operation of Part 1 Type B block interleaving for 256QAM.	30
Figure 6.10 Mapper structure.	31
Figure 6.11 De-multiplexing of bits into sub-streams.	33
Figure 6.12 Example 16-NUC for code rate 6/15.	34
Figure 6.13 Example 1024-NUC for code rate 6/15.	35
Figure 6.14 Block diagram of LDM encoding.	35
Figure 6.15 Constellation superposition for two-layer LDM.	36
Figure 6.16 Examples of (a, left) Core Layer and (b, right) Enhanced Layer constellations.	38
Figure 6.17 Example combined constellation after normalization.	39
Figure 6.18 Block diagram of L1-Basic protection.	39
Figure 6.19 Block diagram of the L1-Detail protection.	40
Figure 6.20 Format of data after LDPC encoding of L1-Basic/-Detail signaling.	42
Figure 6.21 Parity interleaved LDPC codeword bit groups.	44
Figure 6.22 Parity Repetition ($Nrepeat \leq Nldpc_parity$).	46
Figure 6.23 Parity Repetition ($Nrepeat > Nldpc_parity$).	46
Figure 6.24 Example 1 of parity puncturing after repetition.	48
Figure 6.25 Example 2 of parity puncturing after repetition.	48

Figure 6.26 Example of removal of zero-padding bits.	48
Figure 6.27 Block interleaving scheme.	49
Figure 6.28 Example of bit demultiplexing rule for 16-NUC.	49
Figure 6.29 Segmentation of L1-Detail signaling.	51
Figure 6.30 Additional parity for L1-Detail signaling.	52
Figure 6.31 Repeated LDPC codeword.	52
Figure 6.32 Additional parity generation for L1-Detail signaling ($N_{AP} \leq N_{punc}$).	54
Figure 6.33 Additional parity generation for L1-Detail signaling ($N_{AP} > N_{punc}$).	54
Figure 7.1 Block diagram of framing and interleaving.	55
Figure 7.2 Block diagram for time interleaving for CTI Mode.	57
Figure 7.3 Block diagram of the Convolutional Time Interleaver.	57
Figure 7.4 Block diagram for time interleaving for HTI mode.	59
Figure 7.5 Block diagram of the Cell Interleaver: (a) Linear writing operation, (b) Pseudo-random reading operation.	60
Figure 7.6 Example of joint operation of TBI and CDL in the HTI.	62
Figure 7.7 Block diagram of Twisted Block Interleaver: (a) linear writing operation, (b) diagonal-wise reading operation.	64
Figure 7.8 Block diagram of Convolutional Delay Line used in the HTI.	65
Figure 7.9 Example of HTI for L1D_plp HTI_inter_subframe = 0 and 1, and for L1D_plp HTI_num_ti_blocks = 0 and 1.	66
Figure 7.10 Frame structure.	68
Figure 7.11 Mapping of L1-Basic and L1-Detail into Preamble symbol(s).	71
Figure 7.12 Data cell addressing when a Preamble symbol is associated with a Subframe.	73
Figure 7.13 Data cell addressing when a Preamble symbol is not associated with a Subframe.	74
Figure 7.14 Data carrier indices for null and active data carriers.	79
Figure 7.15 Data cell indices used for illustrative multiplexing examples.	82
Figure 7.16 Example of cell multiplexing for a single PLP per Subframe.	82
Figure 7.17 Example of time division multiplexing of PLPs.	83
Figure 7.18 LDM Example #1 (1 Core PLP, 1 Enhanced PLP).	84
Figure 7.19 LDM Example #2 (2 Core PLPs, 1 Enhanced PLP).	85
Figure 7.20 LDM Example #3 (2 Core PLPs, 2 Enhanced PLPs).	85
Figure 7.21 LDM Example #4 (1 Core PLP, 3 Enhanced PLPs).	86
Figure 7.22 LDM Example #5 (3 Core PLPs, 1 Enhanced PLP).	87
Figure 7.23 Example Insertion of Enhanced Layer dummy modulation values when the HTI mode is used with Layered-Division Multiplexing.	87
Figure 7.24 Example of frequency division multiplexing of PLPs.	89
Figure 7.25 Example of time and frequency division multiplexing of PLPs.	90
Figure 7.26 Frequency interleaving overview.	90
Figure 7.27 FI address generation scheme for the 8K FFT size.	91

Figure 7.28 FI address generation scheme for the 16K FFT size.	91
Figure 7.29 FI address generation scheme for the 32K FFT size.	92
Figure 8.1 Block diagram of waveform generation.	94
Figure 8.2 Reference sequence generator.	96
Figure 8.3 Block diagram showing example MISO transmission.	102
Figure 8.4 Illustration of the assignment of extra samples to the guard interval of each non-Preamble OFDM symbol in a Frame.	107
Figure 8.5 Illustration of remaining leftover extra samples being assigned to a cyclic postfix of the final OFDM symbol of the final Subframe of the Frame.	108
Figure 9.1 Illustration of the Time Information Position and the time information being transmitted in the Preamble.	119
Figure 9.2 L1D_plp_CTI_fec_block_start graphical description.	130
Figure C.2.1 Constellation of QPSK.	174
Figure C.2.2 Constellations of 16QAM.	174
Figure C.2.3 Constellations of 64QAM.	175
Figure C.2.4 Constellations of 256QAM.	175
Figure C.2.5 Constellations of 1024QAM.	176
Figure C.2.6 Constellations of 4096QAM.	176
Figure E.1.1 Scattered pilot pattern SP3_2 (SISO, $D_X = 3$, $D_Y = 2$).	184
Figure E.1.2 Scattered pilot pattern SP3_4 (SISO, $D_X = 3$, $D_Y = 4$).	184
Figure E.1.3 Scattered pilot pattern SP4_2 (SISO, $D_X = 4$, $D_Y = 2$).	184
Figure E.1.4 Scattered pilot pattern SP4_4 (SISO, $D_X = 4$, $D_Y = 4$).	185
Figure E.1.5 Scattered pilot pattern SP6_2 (SISO, $D_X = 6$, $D_Y = 2$).	185
Figure E.1.6 Scattered pilot pattern SP6_4 (SISO, $D_X = 6$, $D_Y = 4$).	185
Figure E.1.7 Scattered pilot pattern SP8_2 (SISO, $D_X = 8$, $D_Y = 2$).	185
Figure E.1.8 Scattered pilot pattern SP8_4 (SISO, $D_X = 8$, $D_Y = 4$).	186
Figure E.1.9 Scattered pilot pattern SP12_2 (SISO, $D_X = 12$, $D_Y = 2$).	186
Figure E.1.10 Scattered pilot pattern SP12_4 (SISO, $D_X = 12$, $D_Y = 4$).	186
Figure E.1.11 Scattered pilot pattern SP16_2 (SISO, $D_X = 16$, $D_Y = 2$).	186
Figure E.1.12 Scattered pilot pattern SP16_4 (SISO, $D_X = 16$, $D_Y = 4$).	187
Figure E.1.13 Scattered pilot pattern SP24_2 (SISO, $D_X = 24$, $D_Y = 2$).	187
Figure E.1.14 Scattered pilot pattern SP24_4 (SISO, $D_X = 24$, $D_Y = 4$).	187
Figure E.1.15 Scattered pilot pattern SP32_2 (SISO, $D_X = 32$, $D_Y = 2$).	187
Figure E.1.16 Scattered pilot pattern SP32_4 (SISO, $D_X = 32$, $D_Y = 4$).	188
Figure K.1.1 Simple block diagram of channel bonding.	214
Figure K.1.2 Transmitter side processing for channel bonding.	215
Figure K.3.1 Cell exchange block.	216
Figure K.4.1 Block diagram of channel bonding with LDM.	218
Figure L.1.1 MIMO block diagram.	220

Figure L.1.2 MIMO MAP block diagram.	220
Figure L.5.1 Generic MIMO Precoding block diagram.	222
Figure L.5.2 Detailed MIMO precoding block diagram.	222
Figure L.9.1 MIMO pilot scheme MP3_2 for Walsh-Hadamard pilot encoding.	230
Figure L.9.2 MIMO pilot scheme MP3_4 for Walsh-Hadamard pilot encoding.	230
Figure L.9.3 MIMO pilot scheme MP4_2 for Walsh-Hadamard pilot encoding.	230
Figure L.9.4 MIMO pilot scheme MP4_4 for Walsh-Hadamard pilot encoding.	231
Figure L.9.5 MIMO pilot scheme MP6_2 for Walsh-Hadamard pilot encoding.	231
Figure L.9.6 MIMO pilot scheme MP6_4 for Walsh-Hadamard pilot encoding.	231
Figure L.9.7 MIMO pilot scheme MP8_2 for Walsh-Hadamard pilot encoding.	231
Figure L.9.8 MIMO pilot scheme MP8_4 for Walsh-Hadamard pilot encoding.	232
Figure L.9.9 MIMO pilot scheme MP12_2 for Walsh-Hadamard pilot encoding.	232
Figure L.9.10 MIMO pilot scheme MP12_4 for Walsh-Hadamard pilot encoding.	232
Figure L.9.11 MIMO pilot scheme MP16_2 for Walsh-Hadamard pilot encoding.	232
Figure L.9.12 MIMO pilot scheme MP16_4 for Walsh-Hadamard pilot encoding.	233
Figure L.9.13 MIMO pilot scheme MP3_2 for null pilot encoding.	233
Figure L.9.14 MIMO pilot scheme MP3_4 for null pilot encoding.	233
Figure L.9.15 MIMO pilot scheme MP4_2 for null pilot encoding.	234
Figure L.9.16 MIMO pilot scheme MP4_4 for null pilot encoding.	234
Figure L.9.17 MIMO pilot scheme MP6_2 for null pilot encoding.	234
Figure L.9.18 MIMO pilot scheme MP6_4 for null pilot encoding.	234
Figure L.9.19 MIMO pilot scheme MP8_2 for null pilot encoding.	235
Figure L.9.20 MIMO pilot scheme MP8_4 for null pilot encoding.	235
Figure L.9.21 MIMO pilot scheme MP12_2 for null pilot encoding.	235
Figure L.9.22 MIMO pilot scheme MP12_4 for null pilot encoding.	235
Figure L.9.23 MIMO pilot scheme MP16_2 for null pilot encoding.	236
Figure L.9.24 MIMO pilot scheme MP16_4 for null pilot encoding.	236
Figure L.9.25 MIMO pilot scheme MP24_2 for null pilot encoding.	236
Figure L.9.26 MIMO pilot scheme MP24_4 for null pilot encoding.	236
Figure L.9.27 MIMO pilot scheme MP32_2 for null pilot encoding.	237
Figure L.9.28 MIMO pilot scheme MP32_4 for null pilot encoding.	237
Figure L.13.1 Block diagram of the channel bonding with MIMO system architecture.	240
Figure L.13.2 Cell exchange block for each Polarization, Tx1 and Tx2.	240
Figure M.3.1 Implementation example of the ACE algorithm for 1-D constellations.	245
Figure M.3.2 Implementation example of the ACE algorithm for 2-D constellations.	247
Figure M.3.3 Constellation diagram for 16QAM when using the defined ACE algorithm.	249
Figure M.3.4 Constellation diagram for 64QAM when using the defined ACE algorithm.	250
Figure M.3.5 Constellation diagram for 256QAM when using the defined ACE algorithm.	251

Figure N.1.1 TxID generation and injection into ATSC 3.0 host signals.	252
Figure N.2.1 TxID signal injection into the first Preamble symbol period (8K FFT).	253
Figure N.2.2 TxID signal injection into the first Preamble symbol period (16K FFT).	253
Figure N.2.3 TxID signal injection into the first Preamble symbol period (32K FFT).	253
Figure N.2.4 TxID code generator based on Gold sequence.	253
Figure O.1.1 Comprehensive block diagram for Layered MIMO.	257
Figure O.1.2 Block diagram of Layered MIMO Type A.	258
Figure O.1.3 Block diagram of Layered MIMO Type B.	258
Figure O.6.1 Constellation superposition for Layered MIMO Type A.	260
Figure O.6.2 Constellation superposition for Layered MIMO Type B.	261

Index of Tables

Table 5.1 OFI Description	15
Table 5.2 EXT_TYPE Field Description for Extension Mode	17
Table 6.1 Length of $K_{payload}$ (bits) for $N_{inner} = 64800$	20
Table 6.2 Length of $K_{payload}$ (bits) for $N_{inner} = 16200$	20
Table 6.3 BCH Polynomials	21
Table 6.4 Structure of LDPC Encoding Used for Each of the Code Rates and Lengths	22
Table 6.5 Coding Parameters for Type A: $N_{inner} = 64800$	24
Table 6.6 Coding Parameters for Type A: $N_{inner} = 16200$	24
Table 6.7 Coding Parameters for Type B	24
Table 6.8 Block Interleaver Type for Codes of Length $N_{inner} = 64800$ Bits	27
Table 6.9 Block Interleaver Type for Codes of Length $N_{inner} = 16200$ Bits	27
Table 6.10 Type A Block Interleaver Configurations	27
Table 6.11 Parameters for Type B Block Interleaver	29
Table 6.12 Mandatory Modulation and Coding Combinations $N_{inner} = 64800$ Bits	32
Table 6.13 Mandatory Modulation and Coding Combinations $N_{inner} = 16200$ Bits	32
Table 6.14 Parameters for Bit-Mapping into Constellations	32
Table 6.15 Power Distributions Between Layers for Various Injection Levels	36
Table 6.16 Scaling and Normalizing Factors According to Enhanced Layer Injection Level	37
Table 6.17 Configurations for L1-Basic and L1-Detail Signaling	41
Table 6.18 Parameters for BCH Encoding of L1 Information	41
Table 6.19 Parameters for Zero Padding	42
Table 6.20 Shortening Pattern of Information Bit Group to be Padded	43
Table 6.21 Group-wise Interleaving Pattern for all L1-Basic Modes, L1-Detail Modes 1 and 2	45
Table 6.22 Group-wise Interleaving Pattern for L1-Detail Modes 3, 4, 5, 6 and 7	45
Table 6.23 Parameters for Repetition	46
Table 6.24 Parameters for Puncturing	47
Table 6.25 K_{seg} for L1-Detail Signaling	50
Table 7.1 Number of Carriers NoC and Occupied Bandwidth	69
Table 7.2 Number of Available Data Cells per Preamble Symbol	75
Table 7.3 Number of Available Data Cells per Data Symbol	76
Table 7.4 Number of Available Data Cells per Data Symbol	77
Table 7.5 Total Number of Data Cells in a Subframe Boundary Symbol	78
Table 7.6 Total Number of Data Cells in a Subframe Boundary Symbol	78
Table 7.7 Example Parameters for the Cell Multiplexing of a Single PLP	82
Table 7.8 Example Parameters for Time Division Multiplexing of PLPs	83
Table 7.9 Example Parameters for Frequency Division Multiplexing of PLPs	88
Table 7.10 Example Parameters for Time and Frequency Division Multiplexing of PLPs	89

Table 7.11 Values of M_{max} for the Frequency Interleaver	92
Table 7.12 Wire Permutations for the 8K FFT Size	93
Table 7.13 Wire Permutations for the 16K FFT Size	93
Table 7.14 Wire Permutations for the 32K FFT Size	93
Table 8.1 Presence of the Various Types of Pilots in Each Type of Symbol	95
Table 8.2 Parameters D_X and D_Y Defining the SISO Scattered Pilot Patterns	96
Table 8.3 Allowed Scattered Pilot Pattern for Each Combination of FFT Size and Guard Interval Pattern in SISO Mode	97
Table 8.4 Number of Common Continual Pilots in Each FFT Size	98
Table 8.5 Boosting for the Common Continual Pilots	98
Table 8.6 Exact Power (dB) and Approximate Amplitudes of the Preamble Pilots	100
Table 8.7 Approximate Elementary Periods T	104
Table 8.8 OFDM Parameters	105
Table 8.9 Duration of the Guard Intervals in Samples	106
Table 9.1 Defined Values of bsr_coefficient	109
Table 9.2 L1-Basic Signaling Fields and Syntax	109
Table 9.3 Signaling Format for L1B_mimo_scattered_pilot_encoding	110
Table 9.4 Signaling Format for L1B_time_info_flag	110
Table 9.5 Signaling Format for L1B_papr_reduction	111
Table 9.6 Signaling Format for L1B_L1_Detail_fec_type	113
Table 9.7 Signaling Format for L1B_additional_parity_mode	113
Table 9.8 Use Cases and Indications Related to MIMO: Signaling Format for L1B_first_sub_mimo_mixed in Conjunction with L1B_first_sub_mimo	114
Table 9.9 L1-Detail Signaling Fields and Syntax	116
Table 9.10 Use Cases and Indications Related to MIMO: Signaling Format for L1D_mimo_mixed in Conjunction with L1D_mimo	120
Table 9.11 Signaling Format for L1D_miso and L1B_first_sub_miso	121
Table 9.12 Signaling Format for L1D_fft_size and L1B_first_sub_fft_size	121
Table 9.13 Signaling Format for L1D_guard_interval and L1B_first_sub_guard_interval	121
Table 9.14 Signaling Format for L1D_scattered_pilot_pattern and L1B_first_sub_scattered_pilot_pattern for SISO	122
Table 9.15 Signaling Format for L1D_scattered_pilot_pattern and L1B_first_sub_scattered_pilot_pattern for MIMO	122
Table 9.16 Signaling Format for L1D_scattered_pilot_boost (power in dB)	122
Table 9.17 Equivalent Signaling Format for L1D_scattered_pilot_boost (amplitude)	123
Table 9.18 Signaling Format for L1D_plp_scrambler_type	124
Table 9.19 Signaling Format for L1D_plp_fec_type	125
Table 9.20 Signaling Format for L1D_plp_mod for SISO	125

Table 9.21 Signaling Format for L1D_plp_mod for MIMO	125
Table 9.22 Signaling Format for L1D_plp_cod	126
Table 9.23 Signaling Format for L1D_plp_TI_mode	126
Table 9.24 Signaling Format for L1D_plp_ldm_injection_level	127
Table 9.25 Signaling Format for L1D_plp_channel_bonding_format	128
Table 9.26 Signaling Format for L1D_plp_CTI_depth	129
Table A.1.1 Rate = 2/15 ($N_{inner} = 64800$)	132
Table A.1.2 Rate = 3/15 ($N_{inner} = 64800$)	133
Table A.1.3 Rate = 4/15 ($N_{inner} = 64800$)	134
Table A.1.4 Rate = 5/15 ($N_{inner} = 64800$)	135
Table A.1.5 Rate = 6/15 ($N_{inner} = 64800$)	136
Table A.1.6 Rate = 7/15 ($N_{inner} = 64800$)	137
Table A.1.7 Rate = 8/15 ($N_{inner} = 64800$)	138
Table A.1.8 Rate = 9/15 ($N_{inner} = 64800$)	139
Table A.1.9 Rate = 10/15 ($N_{inner} = 64800$)	140
Table A.1.10 Rate = 11/15 ($N_{inner} = 64800$)	141
Table A.1.11 Rate = 12/15 ($N_{inner} = 64800$)	142
Table A.1.12 Rate = 13/15 ($N_{inner} = 64800$)	143
Table A.2.1 Rate = 2/15 ($N_{inner} = 16200$)	144
Table A.2.2 Rate = 3/15 ($N_{inner} = 16200$)	144
Table A.2.3 Rate = 4/15 ($N_{inner} = 16200$)	144
Table A.2.4 Rate = 5/15 ($N_{inner} = 16200$)	145
Table A.2.5 Rate = 6/15 ($N_{inner} = 16200$)	145
Table A.2.6 Rate = 7/15 ($N_{inner} = 16200$)	145
Table A.2.7 Rate = 8/15 ($N_{inner} = 16200$)	146
Table A.2.8 Rate = 9/15 ($N_{inner} = 16200$)	146
Table A.2.9 Rate = 10/15 ($N_{inner} = 16200$)	146
Table A.2.10 Rate = 11/15 ($N_{inner} = 16200$)	147
Table A.2.11 Rate = 12/15 ($N_{inner} = 16200$)	147
Table A.2.12 Rate = 13/15 ($N_{inner} = 16200$)	148
Table B.1.1 QPSK ($N_{inner} = 64800$)	149
Table B.1.2 16QAM ($N_{inner} = 64800$)	152
Table B.1.3 64QAM ($N_{inner} = 64800$ bits)	154
Table B.1.4 256QAM ($N_{inner} = 64800$)	156
Table B.1.5 1024QAM ($N_{inner} = 64800$)	158
Table B.1.6 4096QAM ($N_{inner} = 64800$)	160
Table B.2.1 QPSK ($N_{inner} = 16200$)	162
Table B.2.2 16QAM (Code length = 16200 bits)	163

Table B.2.3 64QAM ($N_{inner} = 16200$)	164
Table B.2.4 256QAM ($N_{inner} = 16200$)	165
Table C.1.1 QPSK Definition Table for All Code Rates	166
Table C.1.2 16QAM Definition Table for Code Rates 2/15-7/15	166
Table C.1.3 16QAM Definition Table for Code Rates 8/15-13/15	166
Table C.1.4 64QAM Definition Table for Code Rates 2/15-7/15	167
Table C.1.5 64QAM Definition Table for Code Rates 8/15-13/15	167
Table C.1.6 256QAM Definition Table for Code Rates 2/15-7/15	168
Table C.1.7 256QAM Definition Table for Code Rates 8/15-13/15	169
Table C.1.8 1024QAM Definition Table for Code Rates 2/15-7/15	171
Table C.1.9 1024QAM Definition Table for Code Rates 8/15-13/15	171
Table C.1.10 4096QAM Definition Table for Code Rates 2/15-7/15	172
Table C.1.11 4096QAM Definition Table for Code Rates 8/15-13/15	173
Table C.3.1 Constellation Mapping for the Real Part of 1024QAM	177
Table C.3.2 Constellation Mapping for the Imaginary Part of 1024QAM	177
Table C.3.3 Constellation Mapping for the Real Part of 4096QAM	178
Table C.3.4 Constellation Mapping for the Imaginary Part of 4096QAM	179
Table D.1.1 Common CP Absolute Carrier Indices CP_{32}	180
Table D.1.2 Common CP Absolute Carrier Indices CP_{16}	181
Table D.1.3 Common CP Absolute Carrier Indices CP_8	181
Table D.1.4 Additional Scattered Pilot Bearing Continual Pilot Relative Carrier Indices for Each FFT Size and Scattered Pilot Pattern Combination	182
Table D.1.5 Additional Scattered Pilot Bearing Continual Pilot Relative Carrier Indices for SP32_4 in 8K FFT	183
Table F.1.1 Number of Active Data Cells in a SBS when $C_{red_coeff}=0$	189
Table F.1.2 Number of Active Data Cells in a SBS when $C_{red_coeff}=0$	190
Table F.1.3 Number of Active Data Cells in a SBS when $C_{red_coeff}=1$	190
Table F.1.4 Number of Active Data Cells in a SBS when $C_{red_coeff}=1$	191
Table F.1.5 Number of Active Data Cells in a SBS when $C_{red_coeff}=2$	191
Table F.1.6 Number of Active Data Cells in a SBS when $C_{red_coeff}=2$	192
Table F.1.7 Number of Active Data Cells in a SBS when $C_{red_coeff}=3$	192
Table F.1.8 Number of Active Data Cells in a SBS when $C_{red_coeff}=3$	193
Table F.1.9 Number of Active Data Cells in a SBS when $C_{red_coeff}=4$	193
Table F.1.10 Number of Active Data Cells in a SBS when $C_{red_coeff}=4$	194
Table G.1.1 Table Indices Corresponding to the Set of Reserved Carriers for PAPR Reduction According to Each Type of Symbol	195
Table G.1.2 Set of Carriers Reserved for PAPR reduction for All Symbols Except the First Preamble Symbol, the Other ($N_P - 1$) Preamble Symbols of $D_X = 3$, $D_X = 4$, and $D_X = 8$, and Subframe Boundary Symbols of $D_X = 3$, $D_X = 4$, and $D_X = 8$	196

Table G.1.3 Set of Carriers Reserved for PAPR reduction in Preamble Symbols of $D_X=3$, $D_X=4$, and $D_X=8$ Except the First Preamble Symbol and in Subframe Boundary Symbols of $D_X=3$, $D_X=4$, and $D_X=8$	197
Table H.1.1 Meaning of Signaled Values of preamble_structure	198
Table I.1.1 Frequency Domain Total Power of the Preamble Symbol ($P_{\text{Preamble,l}}$)	202
Table I.2.1 Frequency Domain Total Power of Each Data and Subframe Boundary Symbol ($P_{\text{data,m}}$) when $C_{\text{red_coeff}}=0$	203
Table I.2.2 Frequency Domain Total Power of Each Data and Subframe Boundary Symbol ($P_{\text{data,m}}$) when $C_{\text{red_coeff}}=1$	204
Table I.2.3 Frequency Domain Total Power of Each Data and Subframe Boundary Symbol ($P_{\text{data,m}}$) when $C_{\text{red_coeff}}=2$	205
Table I.2.4 Frequency Domain Total Power of Each Data and Subframe Boundary Symbol ($P_{\text{data,m}}$) when $C_{\text{red_coeff}}=3$	206
Table I.2.5 Frequency Domain Total Power of Each Data and Subframe Boundary Symbol ($P_{\text{data,m}}$) when $C_{\text{red_coeff}}=4$	207
Table J.1.1 Time Domain Impulse Response Vectors for $NMISO=64$	209
Table J.1.2 Time Domain Impulse Response Vectors for $NMISO=256$	210
Table L.4.1 Bits Per Cell Unit and Modulation for MIMO	221
Table L.5.1 Rotation Angle for the Stream Combining	223
Table L.9.1 MIMO Pilot Polarization Encoding Overview	225
Table L.9.2 MIMO Pilot Schemes with Equivalent SISO Pilot Schemes and D_X and D_Y Values	228
Table L.9.3 Allowed Scattered Pilot Patterns for Each Allowed Combination of FFT Size and Guard Interval Length in MIMO Mode with Walsh-Hadamard Encoding	228
Table L.9.4 Allowed Scattered Pilot Patterns for Each Allowed Combination of FFT Size and Guard Interval Length in MIMO Mode with Null Pilot Encoding	229
Table M.3.1 ACE Algorithm Used for Each Modulation and Code Rate Combination	244
Table M.3.2 Values of Angle θ of ACE Algorithm for 2-Dimensional Constellations	248
Table N.2.1 Code Sequence Generator Preloading	254
Table N.3.1 TxID Injection Levels Below Host ATSC 3.0 Preamble	256
Table O.12.1 Scaling Factors According to Enhanced Layer Injection Level in Layered MIMO	265
Figure O.13.1 Comprehensive block diagram of Layered MIMO with channel bonding.	267

ATSC Standard: Physical Layer Protocol

1. SCOPE

This Standard describes the RF/Transmission of a physical layer waveform. This waveform enables flexible configurations of physical layer resources to target a variety of operating modes. The intent is to signal the applied technologies and allow for future technology adaptation.

1.1 Introduction and Background

The ATSC physical layer protocol is intended to offer far more flexibility, robustness and efficient operations than the ATSC A/53 standard, and as a result it is non-backwards compatible with A/53. This physical layer allows broadcasters to choose from among a wide variety of physical layer parameters for personalized broadcaster performance that can satisfy many different broadcaster needs. There is the capability to have high-capacity/low-robustness and low-capacity/high-robustness modes in the same emission. Technologies can be selected for special use cases like Single Frequency Networks, Multiple Input Multiple Output channel operation, channel bonding and more, well beyond a single transmitting tower. There is a large range of selections for robustness including, but not limited to, a wide range of guard interval lengths, forward error correction code lengths and code rates.

Significant flexibility comes from a signaling structure that allows the physical layer to change technologies and evolve over time, while maintaining support of other ATSC systems. The starting point of this change is a physical layer offering highly spectral efficient operation with strong robustness across many different modes of operation.

1.2 Organization

This document is organized as follows:

- Section 1 – The scope of this document and general introduction
- Section 2 – References and applicable documents
- Section 3 – Definition of terms, acronyms, and abbreviations used
- Section 4 – System overview
- Section 5 – The specification in detail for the Input Formatting part
- Section 6 – The specification in detail for the Bit-Interleaved Coded Modulation part
- Section 7 – The specification in detail for the Framing and Interleaving part
- Section 8 – The specification in detail for the Waveform Generation part
- Section 9 – The specification in detail for the Physical Layer Signaling
- Annex A– LDPC Codes
- Annex B– Bit Interleaver sequences
- Annex C– Constellation Definitions and Figures
- Annex D– Continual Pilot (CP) Patterns
- Annex E– Scattered Pilot (SP) Patterns
- Annex F– Number of Active Carriers in Subframe Boundary Symbols
- Annex G– Tone Reservation Carrier Indices
- Annex H– Preamble Parameters for Bootstrap

- Annex I– Total Symbol Power
- Annex J– MISO
- Annex K– Channel Bonding of multiple RF channels
- Annex L– MIMO
- Annex M– PAPR Reduction Algorithms (Informative)
- Annex N– Transmitter Identification (TxID)
- Annex O – Combination of LDM and MIMO

2. REFERENCES

All referenced documents are subject to revision. Users of this Standard are cautioned that newer editions might or might not be compatible.

2.1 Normative References

The following documents, in whole or in part, as referenced in this document, contain specific provisions that are to be followed strictly in order to implement a provision of this Standard.

- [1] IEEE: “Use of the International Systems of Units (SI): The Modern Metric System,” Doc. SI 10, Institute of Electrical and Electronics Engineers, New York, NY.
- [2] ATSC: “ATSC Standard: System Discovery and Signaling,” Doc. A/321:2026-04, ATSC, Washington, DC, 14 April 2026.
- [3] ATSC: “ATSC Standard: Link-Layer Protocol,” Doc. A/330:2026-04, ATSC, Washington, DC, 14 April 2026.
- [4] ATSC: “ATSC Standard: Scheduler / Studio-Transmitter Link,” Doc. A/324:2026-04, ATSC, Washington, DC, 14 April 2026.
- [5] IEEE: “IEEE Standard for a Precision Clock Synchronization Protocol for Networked Measurement and Control Systems,” Doc. 1588, Institute of Electrical and Electronics Engineers, New York, NY, approved 27 March 2008.

3. DEFINITION OF TERMS

With respect to definition of terms, abbreviations, and units, the practice of the Institute of Electrical and Electronics Engineers (IEEE) as outlined in the Institute’s published standards [1] shall be used. Where an abbreviation is not covered by IEEE practice or industry practice differs from IEEE practice, the abbreviation in question will be described in Section 3.3 of this document.

3.1 Compliance Notation

This section defines compliance terms for use by this document:

shall – This word indicates specific provisions that are to be followed strictly (no deviation is permitted).

shall not – This phrase indicates specific provisions that are absolutely prohibited.

should – This word indicates that a certain course of action is preferred but not necessarily required.

should not – This phrase means a certain possibility or course of action is undesirable but not prohibited.

3.2 Treatment of Syntactic Elements

This document contains symbolic references to syntactic elements used in the audio, video, and transport coding subsystems. These references are typographically distinguished by the use of a different font (e.g., `restricted`), may contain the underscore character (e.g., `sequence_end_code`) and may consist of character strings that are not English words (e.g., `dynrng`).

3.2.1 Reserved Elements

One or more reserved bits, symbols, fields, or ranges of values (i.e., elements) may be present in this document. These are used primarily to enable adding new values to a syntactical structure without altering its syntax or causing a problem with backwards compatibility, but they also can be used for other reasons.

The ATSC default value for reserved bits is ‘1’. There is no default value for other reserved elements. Use of reserved elements except as defined in ATSC Standards or by an industry standards setting body is not permitted. See individual element semantics for mandatory settings and any additional use constraints. As currently-reserved elements may be assigned values and meanings in future versions of this Standard, receiving devices built to this version are expected to ignore all values appearing in currently-reserved elements to avoid possible future failure to function as intended.

3.3 Acronyms, Abbreviations and Mathematical Operators

The following acronyms and abbreviations are used within this document.

8K	8192 point FFT size
16K	16384 point FFT size
32K	32768 point FFT size
ACE	Active Constellation Extension
ALP	ATSC Link-layer Protocol
AP	Additional Parity
AWGN	Additive White Gaussian Noise
BBP	BaseBand Packet
BCH	Bose, Chaudhuri, Hocquenghem
BICM	Bit-Interleaved Coded Modulation
BIL	Bit InterLeaver
bpcu	bits per cell unit
BPSK	Binary Phase Shift Keying
BSID	Broadcast Stream ID
BSR	Baseband Sampling Rate
CDL	Convolutional Delay Line
CL	Core Layer
Cod	Code rate
CP	Continual Pilot
CRC	Cyclic Redundancy Check
CTI	Convolutional Time Interleaver
dB	deciBel
DC	Direct Current

DRC	Dedicated Return Channel
DSBSS	Direct Sequence Buried Spread Spectrum
EL	Enhanced Layer
FEC	Forward Error Correction
FI	Frequency Interleaver
FBSR	FeedBack Shift Register
FDM	Frequency Division Multiplexing
FFT	Fast Fourier Transform
FIFO	First-In-First-Out
GI	Guard Interval
HTI	Hybrid Time Interleaver
IF	Interleaving Frame
IFFT	Inverse Fast Fourier Transform
ISO	International Organization for Standardization
IU	Interleaving Unit
L1	Layer 1
LDM	Layered Division Multiplexing
LDPC	Low Density Parity Check
LLS	Low Level Signaling
LPF	Low Pass Filter
LSB	Least Significant Bit
Mbps	Megabits per second
MHz	Megahertz
MIMO	Multiple Input Multiple Output
MISO	Multiple Input Single Output
Mod	Modulation
MSB	Most Significant Bit
ms	milliseconds
N/A	Not Allowed
NoA	Number of Active (cells)
NoC	Number of (useful) Carriers
NUC	Non-Uniform Constellation
OFDM	Orthogonal Frequency Division Multiplexing
OFI	Optional Field Indicator
OTA	Over The Air
PAM	Pulse Amplitude Modulation
PAPR	Peak-to-Average Power Ratio
PH	Phase Hopping
PLP	Physical Layer Pipe
PRBS	Pseudo Random Binary Sequence
PTP	Precision Time Protocol
QAM	Quadrature Amplitude Modulation

QPSK	Quadrature Phase Shift Keying
RF	Radio Frequency
RFU	Reserved for Future Use
SBS	Subframe Boundary Symbol
SFN	Single Frequency Network
SIMO	Single Input Multiple Output
SISO	Single Input Single Output
SNR	Signal-to-Noise Ratio
SP	Scattered Pilot
STL	Studio-to-Transmitter Link
TAI	International Atomic Time
TBI	Twisted Block Interleaver
TDM	Time Division Multiplexing
TI	Time Interleaver
TR	Tone Reservation
TxID	Transmitter Identification
XOR	eXclusive OR
$\lfloor X \rfloor$	The greatest integer less than or equal to X

3.4 Terms

The following terms are used within this document.

Base Field – The first portion of a Baseband Packet Header.

Baseband Packet – A set of $K_{payload}$ bits which form the input to a FEC encoding process. There is one Baseband Packet per FEC Frame.

Baseband Packet Header – The header portion of a Baseband Packet.

Block Interleaver – An interleaver where the input data is written along the rows of a memory configured as a matrix, and read out along the columns.

Broadcast Stream ID (BSID) – A 16-bit value that identifies the aggregate contents of a broadcast signal. Each transmitted signal that is unique (has content that is different from another signal) has a unique BSID; e.g., a signal translated onto a different frequency has the same BSID.

Cell – One set of encoded I/Q components in a constellation.

Cell Interleaver – An interleaver operating at the cell level.

Combined PLP – A PLP after processing by the LDM injection block.

Concatenated Code – A code having an Outer Code followed by an Inner Code.

Constellation – A set of encoded (I component/Q component) points in the I/Q plane.

Core Layer – The first layer of a 2-layer LDM system. The only layer in a non-LDM system.

Core PLP – A PLP belonging to the Core Layer.

Data Payload Symbols – Data and Subframe Boundary Symbols (i.e. non-Preamble symbols).

Enhanced Layer – The second layer of a 2-layer LDM system.

Enhanced PLP – A PLP belonging to the Enhanced Layer.

Extension Field – The third portion of a Baseband Packet Header.

FEC Frame – A single Baseband Packet with its associated FEC parity bits attached, having a total size of 64800 or 16200 bits (per FEC Frame).

FEC Block – A FEC Frame after mapping to cells.

Frame – A series of bootstrap and post-bootstrap OFDM symbols (consisting of Preamble and one or more subframes) extending from the center of the leading edge of the first sample of the first symbol of a bootstrap to the identical point in the immediately succeeding bootstrap.¹

Frequency Interleaver – An interleaver which takes cells and interleaves them over a particular symbol.

Interleaver – A device used to counteract the effect of burst errors.

Inner Code – One code of a Concatenated Code system.

Layered Division Multiplexing – A multiplexing scheme where multiple PLPs are combined in layers with a specific power ratio.

Layered MIMO – The combination of LDM and MIMO.

Layered MIMO Type A – A mode of operation in which MIMO and LDM both are active and MIMO is applied to both the Core and Enhanced Layers (see Annex O).

Layered MIMO Type B – A mode of operation in which MIMO and LDM both are active and MIMO is applied only to the Enhanced Layer, meaning that the associated Core Layer operates in a SISO configuration (see Annex O).

MIMO (Multiple-Input Multiple-Output) – A technique that allows a higher spectral efficiency and/or a higher transmission robustness, when compared to a single-path (SISO) system, through addition of spatial diversity and multiplexing over two distinct paths between antennas at a transmitter and a receiver (see Annex L).

MIMO mode – A transmission mode in which a PLP is configured to create two transmitter signal paths that ultimately feed a pair of cross-polarized transmitting antennas (see Annex L).

ModCod – A combination of modulation and code rate that together determine the robustness of the PLP and the size of the Baseband Packet.

Non-Uniform Constellation – A constellation with a non-uniform spread of constellation points.

Optional Field – The second portion of a Baseband Packet Header.

Outer Code – One code of a Concatenated Code system.

Physical Layer Pipe – A structure specified to an allocated capacity and robustness that can be adjusted to broadcaster needs.

Polarization – The orientation of the electric field vector of a radiated electromagnetic (radio) wave with respect to the horizon as seen from the antenna, the orientation of the wave emitted from which is described. Such orientation can be fixed linear (i.e., planar) or rotating with time (i.e., circular).

Preamble – The portion of the Frame that carries L1 signaling data for the Frame.

SISO (Single-Input Single-Output) – A transmission system configuration in which only a single path is created between a transmitting antenna and a receiving antenna (as opposed to MIMO, in which two or more paths are created between antennas).

¹ Note: post-bootstrap OFDM symbol constituents (i.e., a Preamble and one or more Subframes) included in the Frame definition herein relate specifically to the post-bootstrap Frame structure described in this standard. Other post-bootstrap structures are possible if signaled by different parameter values in the bootstrap.

Subframe – A series of post-bootstrap, non-Preamble OFDM symbols having the same FFT size, GI length, and number of useful carriers (NoC), and sharing a common scattered pilot pattern, all of which may be placed between optional boundary symbols.

Systematic – A property of a code in which the codeword is composed of the original data in its sequential order followed by the parity data for the codeword.

Time Information Position – The instant at the center of the leading edge of the first sample of the first symbol of a bootstrap.

Time Interleaver – An interleaver which takes cells and interleaves them over a particular time period.

TI Block – An integer number of FEC Blocks.

Twisted Block Interleaver – An interleaver that performs intra-Subframe interleaving by interleaving TI Blocks.

reserved – Set aside for future use by a Standard.

4. SYSTEM OVERVIEW

4.1 Features

The ATSC physical layer protocol is intended to offer the flexibility to choose among many different operating modes depending on desired robustness/efficiency tradeoffs. It is built on the foundation of OFDM modulation with a suite of LDPC FEC codes, of which there are 2 code lengths and 12 code rates defined. There are three basic modes of multiplexing: time, layered and frequency, along with three transmission modes of SISO, MISO and MIMO. Signal protection starts with 12 selectable guard interval lengths to offer long echo protection lengths. Channel estimation can be done with 16 scattered pilot patterns along with continual pilot patterns. Three FFT sizes (8K, 16K and 32K) offer a choice of Doppler protection depending on the anticipated device mobility.

Supported bit rates in a 6MHz channel range from less than 1Mbps in the lowest-capacity most-robust mode, up to over 57Mbps when using the highest-capacity parameters. Data are carried in Physical Layer Pipes (PLPs), which are data structures that can be configured for a wide range of trade-offs between signal robustness and channel capacity utilization for a given data payload. Multiple PLPs can be used to carry different streams of data, all of which are required to assemble a complete delivered product. In addition, data streams required to assemble multiple delivered products can share PLPs if those data streams are to be carried with the same levels of robustness. Combinations of data streams necessary to assemble a particular delivered product are limited to carriage on a maximum of 4 PLPs. These capabilities enable scenarios such as robust audio, video, enhanced video, and application data each being sent on an individual PLP at different robustness levels. For channel impairment mitigation, the time interleaver can be configured for intra-Subframe interleaving up to 200 ms (up to 400 ms in some limited modes using extended interleaving) and larger depths in inter-Subframe interleaving for low-bit rate streams. Frequency interleaving can be used throughout the channel bandwidth on a per symbol basis to separate burst errors in the frequency domain.

These pieces of technology are combined in an order described in the next section. The purpose of the physical layer is to offer a wide range of tools for broadcasters to choose the operating mode(s) that best fits their needs and targeted devices. This toolbox of technology is expected to grow over time and the ability to upgrade or swap out new technology is enabled with the extensive

and extensible signaling in the Preamble. Broadcasters will have the ability to try new technologies out without breaking an existing service.

The bootstrap, as described in [2], shows that each Frame can be different, including non-ATSC related signals. The time of the next similar Frame is signaled so that the existing service can continue. This standard describes the physical layer downlink signals after the bootstrap.

4.2 System Architecture

A block diagram of the main data flow for the total transmitter system architecture is shown in Figure 4.1. The system architecture consists of four main parts: Input Formatting, Bit-Interleaved Coded Modulation (BICM), Framing and Interleaving, and Waveform Generation. For simplicity, control and signaling information flow is not shown in this diagram.

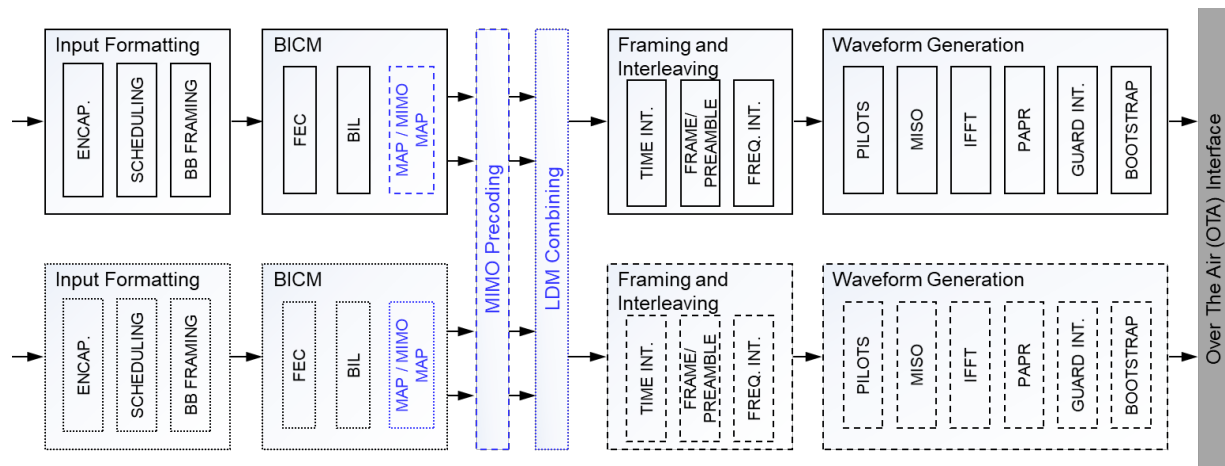

Figure 4.1 Block diagram of the system architecture for one RF channel.

In this specification, Input Formatting is described in Section 5, BICM is described in Section 6, LDM Combining in Section 6.4, Framing and Interleaving in Section 7, and Waveform Generation in Section 8. The signaling required to configure all of the blocks is described in Section 9. MIMO Precoding is described in Annex L.

Not all blocks are used in each configuration. In Figure 4.1 the solid lines show blocks common to all configurations, dotted lines show blocks specific to LDM and dashed lines show blocks specific to MIMO.

If LDM and MIMO are used together (i.e., in a Layered MIMO configuration), MIMO Precoding shall precede LDM Combining. The combined use of LDM and MIMO is described in Annex O.

Although not shown in Figure 4.1, there is an SFN/STL distribution interface located between the Scheduling and Baseband Framing blocks. The definition of interface format for SFNs and transmission from the studio to the tower is defined in [4].

A key concept in the Input Formatting and BICM blocks is the PLP (Physical Layer Pipe) which is a stream of data encoded with a specific modulation, code rate and length. Figure 4.2 and Figure 4.3 show simplified block diagrams when there is only a single PLP (Figure 4.2) and when there are 4 PLPs (Figure 4.3), respectively. For each PLP a separate Input Formatting and BICM block is used. It is noted that after the Framing and Interleaving block there is only one stream of data, as the PLPs have been multiplexed onto OFDM symbols and then arranged in Frames.

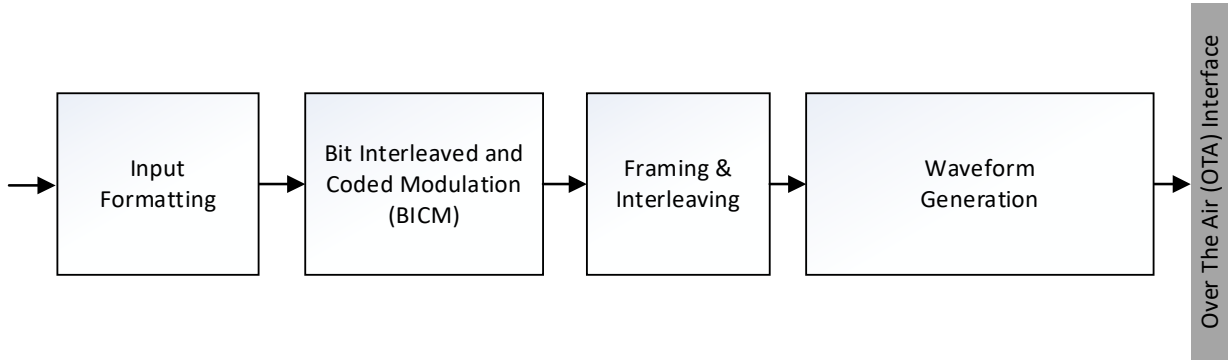

Figure 4.2 Block diagram (simplified) of a single PLP system architecture.

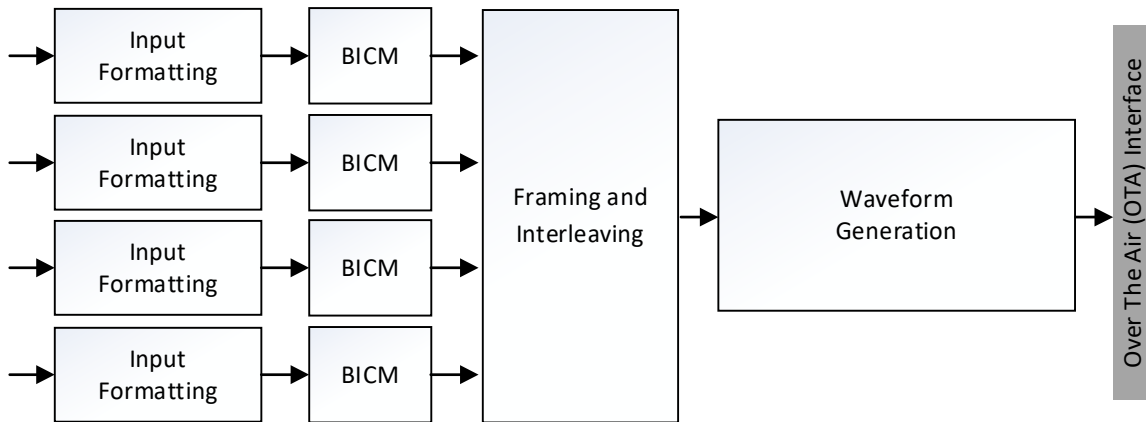

Figure 4.3 Block diagram (simplified) of a multiple PLP system architecture.

Although there are multiple methods of multiplexing the input data supported in this standard, two are described very briefly in this section, specifically Time Division Multiplexing (TDM) and Layered Division Multiplexing (LDM). The system architecture block diagrams for these two methods show how the overall system architecture diagram can be simplified for specific configurations.

In the TDM system architecture there are four main blocks: Input Formatting, Bit-Interleaved Coded Modulation (BICM), Framing and Interleaving and Waveform Generation. Input data is formatted in the Input Formatting block, and forward error correction applied and mapped to constellations in the BICM block. Interleaving, both time and frequency, and Frame creation are done in the Framing and Interleaving block. It is in this block that the time division multiplexing of the multiple PLPs is done. Finally, the output waveform is created in the Waveform Generation block. The TDM system architecture can be realized using the simplified block diagram shown in Figure 4.3.

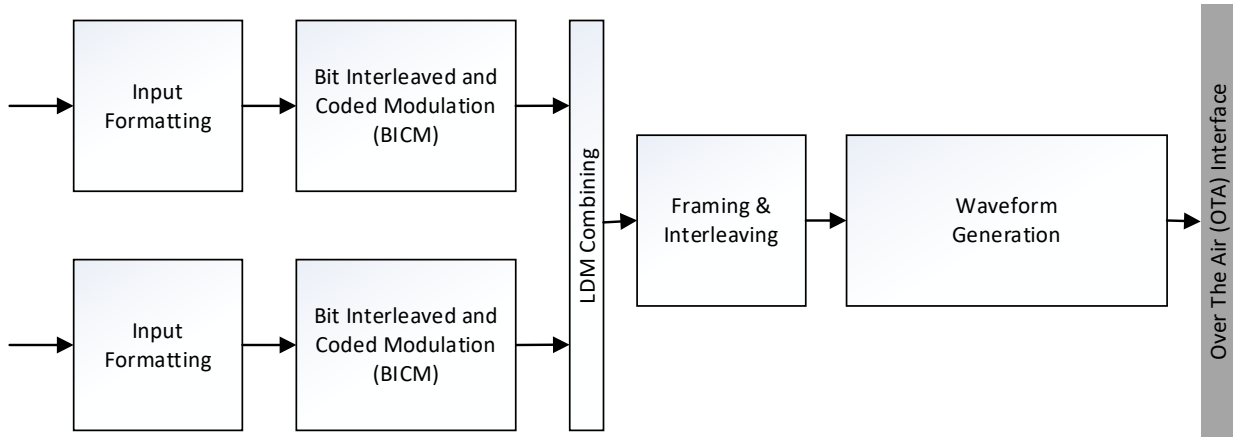

Figure 4.4 Block diagram (simplified) of the LDM system architecture.

In the LDM system architecture, shown in the simplified block diagram in Figure 4.4, in addition to the four blocks that have already been shown in the TDM system, there is an additional block LDM Combining. Before this block there are two corresponding Input Formatting and BICM blocks, one for each of the two LDM layers. After combining the data from each layer, the data passes through the Framing and Interleaving block followed by the Waveform Generation block.

This standard also offers the option to use multiple RF channels through channel bonding, described in Annex K and shown graphically in Figure 4.5. Compared to the TDM architecture, at the transmitter side there is an additional block, Stream Partitioning. The high data rate input stream is partitioned in this block into two separate streams, each passing through a BICM, Framing and Interleaving and Waveform Generation block. Each stream is output onto a separate RF channel. At the receiver side, the outputs of the two RF channels are then combined to achieve greater data rates than can be achieved in one RF channel alone.

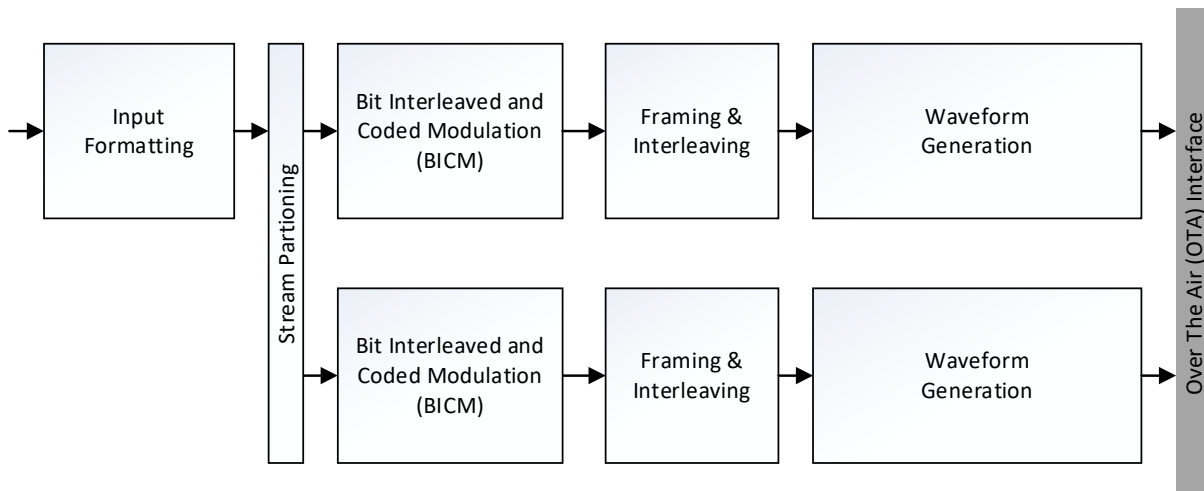

Figure 4.5 Block diagram (simplified) of a channel bonded system.

4.3 Central Concepts

This standard has two concepts at its core: flexibility and efficiency.

For flexibility, the number of modulation and coding combinations offers a breadth of choice for operating point that have not been available in any previous broadcasting standard. Multiple multiplexing methods give options to the broadcaster to configure the transmission chain like never before. Individual blocks may be turned on and off with an extensive set of signaling. Furthermore, this standard has allowed “room to grow” as technologies evolve so that the standard may be extended in the future.

For efficiency, new forward error correcting options with the adoption of non-uniform-constellations has brought the operation of the BICM closer to the theoretical Shannon Limit; offering over 1dB of gain compared to the use of uniform constellations using the same operating parameters.

5. INPUT FORMATTING

The input formatting consists of three blocks: encapsulation and compression of data, baseband framing and the scheduler. This is shown in Figure 5.1. The dotted line represents the flow of control information, while the solid lines represent the flow of data.

The encapsulation and compression operation of data is described in detail in Section 5.1, the operation of the scheduler is described in [4], and the Baseband Packet construction is described in Section 5.2.

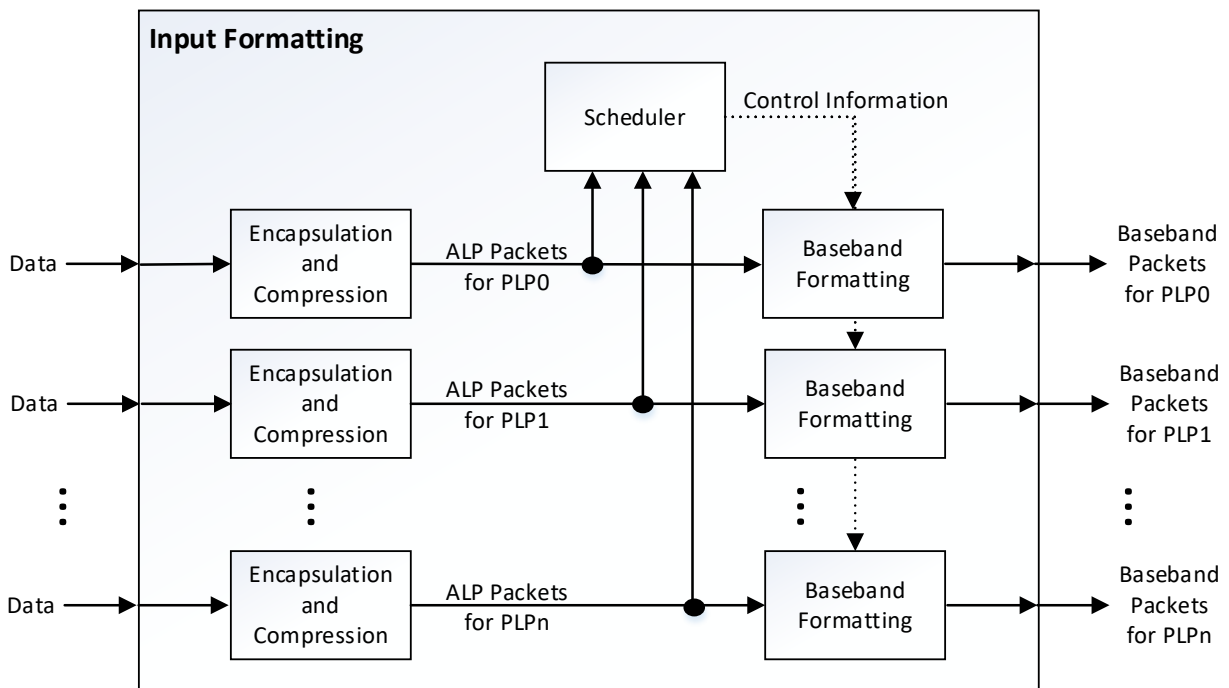

Figure 5.1 Block diagram of input formatting.

5.1 Encapsulation and Compression

Input data packets shall be formatted according to the [3] specification in this block, including all necessary encapsulation and compression of the input data. The output packets are called ALP (ATSC Link-layer Protocol) packets.

The length of each ALP packet is variable and can be extracted from the ALP packet header. The maximum length of any single ALP packet, including all headers and data, shall be as defined and constrained as in [3].

5.1.1 Number of PLPs

The maximum number of PLPs in each RF channel (6, 7 or 8 MHz) shall be 64. The minimum number of PLPs in an RF channel shall be one. The maximum number of PLPs in a Frame carrying content requiring simultaneous recovery to assemble a single delivered product shall be four, subject to the constraints described in Section 7.1.2. Note that Low Level Signaling (LLS) is one component of a delivered product.

5.2 Baseband Formatting

The baseband formatting block, shown in Figure 5.2, consists of three blocks, Baseband Packet Construction, Baseband Packet Header Addition and Baseband Packet Scrambling. The baseband formatting block creates one or more PLPs as directed by the Scheduler. At the output of the baseband formatting block, each PLP consists of a stream of Baseband Packets and there is exactly one Baseband Packet per defined FEC Frame.

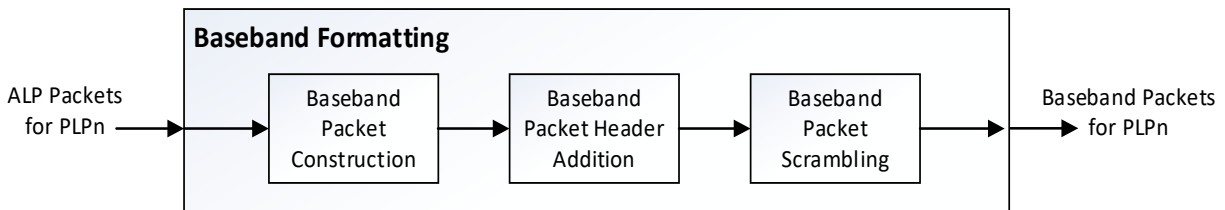

Figure 5.2 Block diagram of baseband formatting.

The mapping operation of ALP packets to Baseband Packets is described in Section 5.2.1, the Baseband Packet Header construction is described in Section 5.2.2 and the scrambling of the entire Baseband Packet is described in Section 5.2.3.

5.2.1 Mapping ALP Packets to Baseband Packets

A Baseband Packet shall consist of a header, described in Section 5.2.2, and a payload containing ALP packets, shown in Figure 5.3. Padding, if present, shall be added to the Baseband Packet Header. Baseband Packets have fixed length $K_{payload}$, with the length determined by the outer code type, inner code rate and code length chosen for the target PLP. For specific values of $K_{payload}$, see Table 6.1 and Table 6.2.

ALP packets shall be mapped to the payload part in the same order they are received. The reordering of ALP packets in the Baseband Packet is not permitted. When the received ALP packets are not sufficient to create a Baseband Packet of size $K_{payload}$, padding shall be added to the Baseband Packet Header to complete the Baseband Packet. See Section 5.2.2.3.2 for details.

When the received ALP packets are enough to fill the Baseband Packet but the last ALP packet does not fit perfectly within the Baseband Packet, that ALP packet may be split between the current Baseband Packet with the remainder of the ALP packet transmitted at the start of the next Baseband Packet. When splitting is used, ALP packets shall be split in byte units only. When the final ALP packet in the Baseband Packet is not split, padding shall be used in the extension field of the Baseband Packet Header to completely fill the Baseband Packet. In Figure 5.3 the final ALP packet is split between the current Baseband Packet and the next Baseband Packet.

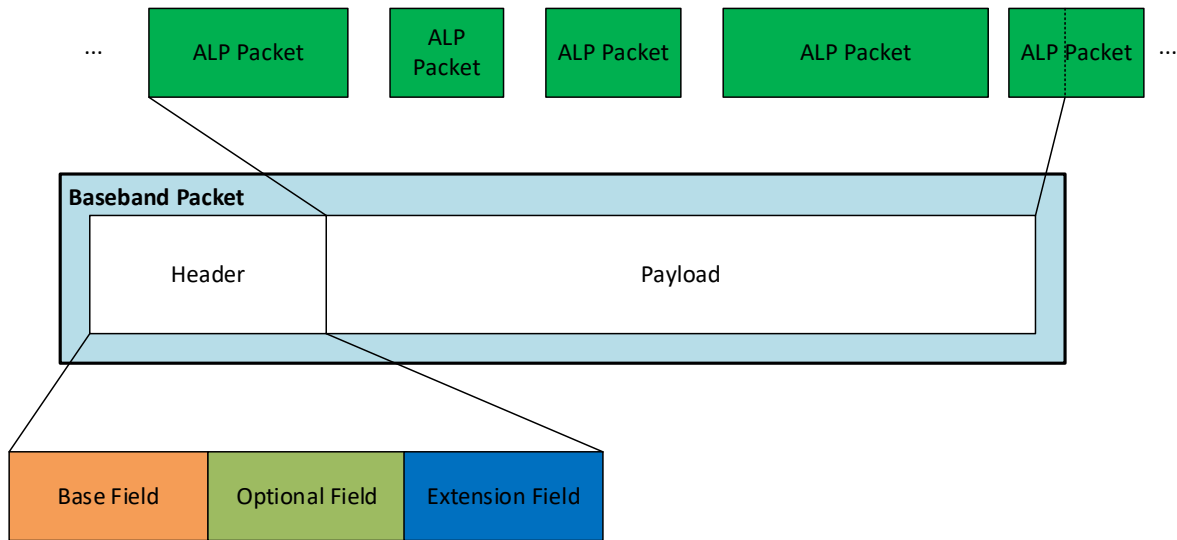

Figure 5.3 Baseband Packet structure showing Header, Payload and mapping example of ALP packets to a Baseband Packet.

5.2.2 Baseband Packet Header

The Baseband Packet Header shall be composed of up to three parts, illustrated in Figure 5.3 and with more detail in Figure 5.4. The first part is called the Base Field and appears in every packet. The second part is called the Optional Field. The third part is called the Extension Field. The order of the fields shall be Base, Optional and Extension. The Optional Field may be used to provide signaling regarding the following Extension Field. When Extension Fields are used, the Optional Field shall always be present.

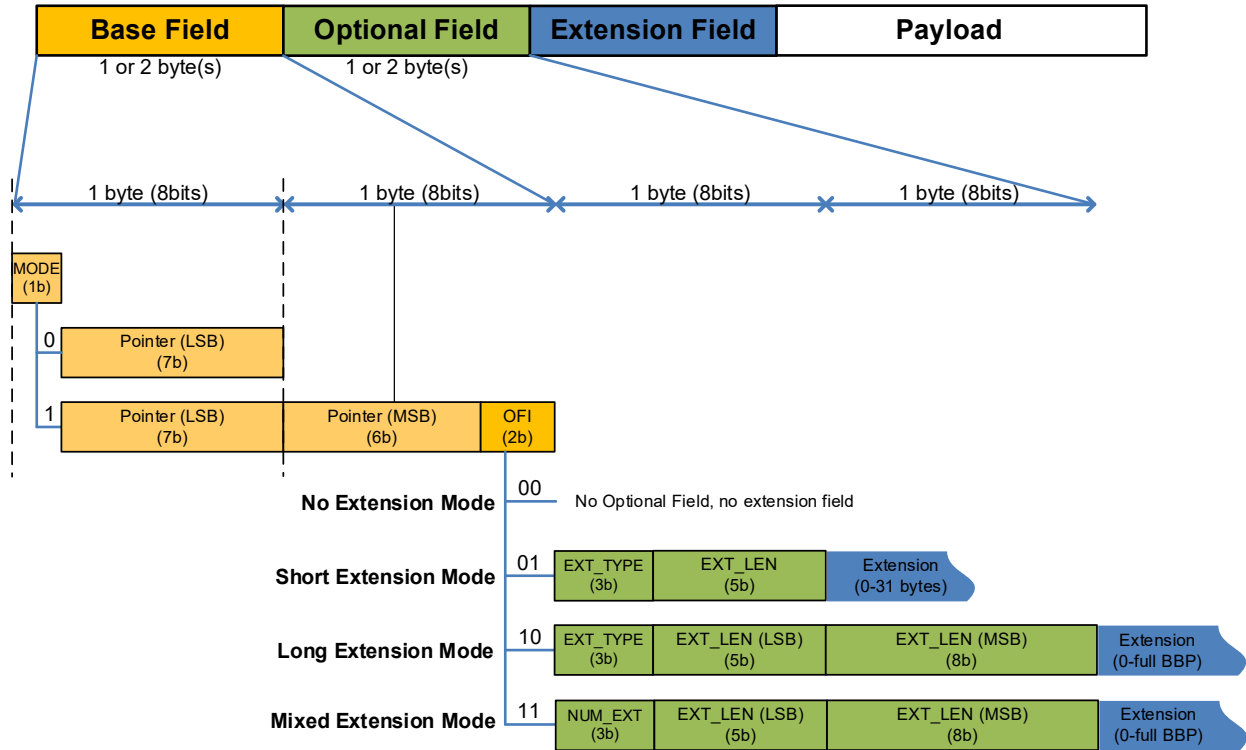

Figure 5.4 Baseband Packet Header structure details.

5.2.2.1 Base Field

Since ALP packets may be split across Baseband Packets, the start of the payload of a Baseband Packet does not necessarily signify the start of an ALP packet. The Base Field of a Baseband Packet shall provide the start position of the first ALP packet that begins in the Baseband Packet through a pointer.

The value of the pointer shall be the offset (in bytes) from the beginning of the payload to the start of the first ALP packet that begins in that Baseband Packet. When an ALP packet begins at the start of the payload portion of a Baseband Packet, the value of the pointer shall be 0. When there is no ALP packet starting within that Baseband Packet, the value of the pointer shall be 8191 and a 2 byte Base Field shall be used. When there are no ALP packets and only padding is present, the value of the pointer shall also be 8191 and a 2 byte Base Field shall be used, together with any necessary Optional Fields and Extension Fields as signaled by the OFI (Optional Field Indicator) field.

Signaling of the Base Field is as defined below:

MODE - This field shall indicate whether the Base Field has a length of one byte (**MODE**=0) or two bytes (**MODE**=1), and shall thus indicate the absence or presence of the upper 6 MSB bits of the pointer field and the **OFI** field.

When **MODE**=0 the pointer value shall be strictly less than 128 bytes. The pointer field length shall be 7 bits and the value of the pointer shall be transmitted in **Pointer_LSB** only. Within **Pointer_LSB** the bits shall be ordered from most significant bit to least significant bit. The length of the Base Field shall be one byte and no Optional Field and Extension Field shall be used.

When **MODE**=1 the pointer field length shall be 13 bits and the pointer field shall consist of a concatenation of the fields **Pointer_LSB** and **Pointer_MSB** in the base field. Within both **Pointer_LSB** and **Pointer_MSB** the bits shall be ordered from most significant bit to least significant bit. The length of the Base Field shall be two bytes and the use of optional and extension fields shall be allowed. Note the order of the concatenation shall be as shown in Figure 5.4, with the lowest 7 bits (LSB) concatenated with the upper 6 bits (MSB). For example, if the decimal value of the pointer is 130, **MODE**=1 and the lower 7 bits of the pointer (0000010) shall be concatenated with the upper 6 bits of the pointer (000001) to give the output of the Baseband Packet Header as 10000010 00000100, assuming **OFI**=0.

Pointer_LSB - This field shall be the 7 least significant bits of the pointer field.

Pointer_MSB - This field shall be the 6 most significant bits of the (13-bit) pointer field.

OFI - This field shall indicate the Baseband Packet Header extension mode, specified in Table 5.1 .

Table 5.1 OFI Description

OFI	Description
00	No Extension Mode: Absence of both Optional and Extension Fields
01	Short Extension Mode: Presence of the Optional Field, with length equal to 1 byte.
10	Long Extension Mode: Presence of the Optional Field, with length equal to 2 bytes.
11	Mixed Extension Mode Presence of the Optional Field, with length equal to 2 bytes

5.2.2.2 Optional Field

The Optional Field shall only be present when **OFI** is set to '01', '10' or '11'. When **OFI**=01 it is known as Short Extension Mode and is defined in Section 5.2.2.2.1. When **OFI** =10 it is known as Long Extension Mode and is defined in Section 5.2.2.2.3. When **OFI** =11 it is known as Mixed Extension Mode and is defined in Section 5.2.2.2.3.

5.2.2.2.1 Short Extension Mode

The Extension Field shall be composed according to the **EXT_TYPE** and **EXT_LEN** fields in the Optional Field. When the actual length of the signaled extension type is shorter than what is indicated by **EXT_LEN**, padding consisting of 0x00 shall be used to fill up the missing bytes as defined in Section 5.2.2.3.2.

The following fields shall be present:

EXT_TYPE: This field shall indicate the type of the extension transmitted in the Extension Field, as defined in Table 5.2. Only one extension type per Baseband Packet shall be used.

EXT_LEN: This field shall indicate the length in bytes of the Extension Field in the range 0-31 bytes. When **EXT_LEN** =0 this implies that no Extension Field is present.

5.2.2.2.2 Long Extension Mode

The Extension Field shall be composed according to the **EXT_TYPE** and **EXT_LEN (LSB)** concatenated with **EXT_LEN (MSB)** fields in the Optional Field. When the actual length of the signaled extension type is shorter than what is indicated by the concatenation of **EXT_LEN (LSB)** and **EXT_LEN (MSB)**, padding with 0x00 shall be used to fill up the missing bytes as defined in Section 5.2.2.3.2.

The following fields shall be present:

EXT_TYPE: This field shall indicate the type of Extension Field, as defined in Table 5.2. Only one extension type per Baseband Packet shall be used.

EXT_LEN (LSB): This field shall indicate the LSB part of the 13-bit **EXT_LEN**

EXT_LEN (MSB): This field shall indicate the MSB part of the 13-bit **EXT_LEN**

The concatenation **EXT_LEN** (13 bits) of the fields **EXT_LEN (LSB)** and **EXT_LEN (MSB)** in the Optional Field shall indicate the actual length in bytes of any Extension Field in the range 0 bytes to the end of the Baseband Packet. When **EXT_LEN** indicates an Extension Field of 0 bytes this implies that no Extension Field is present.

5.2.2.2.3 Mixed Extension Mode

The Extension Field shall consist of N non-padding extensions (where $2 \leq N \leq 7$) as well as any padding. The structure of the Extension Field shall be as defined in Figure 5.5.



Figure 5.5 Structure of Extension Field for the Mixed Extension Mode.

With N non-padding extensions there shall be one 2-byte header for each such extension, i.e. a total header part of the Extension Field of 2N bytes. In the Extension Field all N headers shall first be transmitted, followed by the N associated payload fields, following the same order, and finally any padding.

In each 2-byte header the first byte shall consist of a 3-bit field, **EXT_TYPE**, indicating the extension type followed by the 5-bit LSB part of the 13-bit **EXT_LEN** field of the particular extension. The second byte shall consist of the 8-bit MSB part of the same **EXT_LEN** field, which is the concatenation of the respective LSB and MSB parts. No header shall precede the padding bytes, if present, at the end of the Extension Field. The position and length of padding is implicit from other fields.

The following fields shall be present:

NUM_EXT (3 bits): This field shall indicate the number of non-padding extensions N ($2 \leq N \leq 7$) in the Extension Field.

EXT_LEN (LSB) (5 bits): This field shall indicate the LSB part of the 13-bit **EXT_LEN**

EXT_LEN (MSB) (8 bits): This field shall indicate the MSB part of the 13-bit **EXT_LEN**

The concatenation **EXT_LEN** (13 bits) of the fields **EXT_LEN (LSB)** and **EXT_LEN (MSB)** in the Optional Field shall indicate the actual length in bytes of the Extension Field in the range 4 bytes to end of Baseband Packet.

In the current version of the specification Extension Fields and associated **EXT_TYPE** entries shall be as defined in Table 5.2. Later specification versions may define additional extension types.

Table 5.2 EXT_TYPE Field Description for Extension Mode

EXT_TYPE	Description
000	Counter A counter as defined in Section 5.2.2.3.1 shall be used
001-110	These fields are reserved for future extension types
111	All Padding All bytes of the extension field are padded with 0x00 as defined in Section 5.2.2.3.2.

5.2.2.3 Extension Fields

The Extension Field types are defined below.

5.2.2.3.1 Counter Type

When **EXT_TYPE** = '000' an extension of length **EXT_LEN** bytes containing a counter shall be added. The counter shall be of 2 bytes in length and shall immediately follow the Optional Field. The first byte of the extension shall represent the most significant byte of the counter and the second byte of the extension shall represent the least significant byte of the counter. **EXT_LEN** shall have a minimum value of 2. Values of **EXT_LEN** > 2 shall indicate the presence of padding following the counter. Note that if a Baseband Packet with only padding needs to be sent, **EXT_TYPE** = 111 shall be used and use of the counter type is unnecessary.

The counter shall be initialized to 0 and shall increment linearly by one for each Baseband Packet of the current PLP. Independent counters shall be used for each PLP. When the counter reaches its maximum value, the next Baseband Packet counter value shall be reset to zero and the counting process shall begin again.

For a PLP employing channel bonding, a single counter shall be used to add the value to the Baseband Packet (see also Section K.1). This shall occur before the Baseband Packet is assigned to the specified RF channel.

As an example, if **OFI** = '01' and **EXT_LEN** = '5', the counter will be 2 bytes in length and the remaining 3 bytes of the extension will contain padding. The length of the Base Field is 2 bytes, the length of the Optional Field is 1 byte and the length of the Extension Field is 5 bytes for a total Baseband Packet Header length of 8 bytes.

5.2.2.3.2 All Padding Type

For **OFI** = 01 and **OFI** = 10 an Extension Field may be entirely used for padding by setting **EXT_TYPE** = '111' as described in Table 5.2. When one or more non-padding extensions do not entirely fill the available Extension Field the last part of the Extension Field is filled with padding bytes, which in all cases have the value 0x00. In this latter case there is no explicit padding signaling.

The use of **OFI** = '01' together with an **EXT_LEN** field indicating a 0-byte length of the Extension Field is equivalent to introducing 1 byte of padding, compared to the **OFI** = 00 case.

The use of **OFI** = '10' together with an **EXT_LEN** field indicating a 0-byte length of the Extension Field is equivalent to introducing 2 bytes of padding, compared to the **OFI** = 00 case.

5.2.3 Scrambling of Baseband Packets

In order to ensure that the data mapped to constellations is not assigned to the same point in an undesirable manner (which might occur for example when the payload consists of a repetitive sequence) the entire Baseband Packet, consisting of both the Baseband Packet Header and payload, shall always be scrambled before forward error correction encoding.

The scrambling sequence can be generated by the 16-bit shift register shown in Figure 5.6.

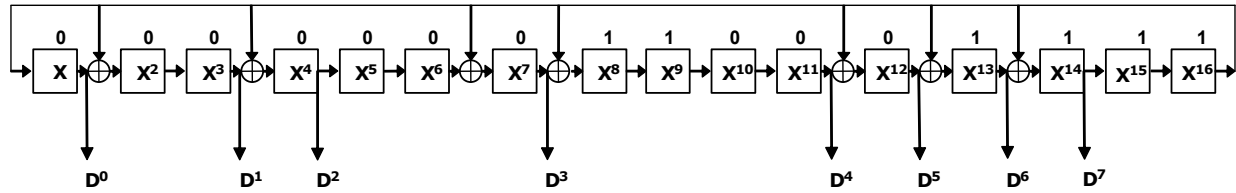

Figure 5.6 Shift register of the PRBS encoder for baseband scrambling.

The generator polynomial shall be:

$$G(x) = 1 + X + X^3 + X^6 + X^7 + X^{11} + X^{12} + X^{13} + X^{16}$$

The operation of the scrambling sequence shall be as follows:

- 1) The initial sequence (0xF180: 1111 0001 1000 0000) shall be loaded into the shift register at the start of every Baseband Packet.
- 2) Eight of the shift register outputs (D^7, D^6, \dots, D^0) are used as a randomizing byte, which shall then be XOR'd bitwise (MSB to MSB and so on until LSB to LSB) with the corresponding byte of Baseband Packet data.
- 3) The bits in the shift register shall be shifted once. Go to step 2 above.

The first values of the baseband scrambling sequence are 1100 0000 0110 1101 0011 1111 ... (MSB first, or $D^7, D^6, \dots, D^0, D^7, D^6, \dots$).

6. BIT-INTERLEAVED CODED MODULATION (BICM)

A simple block diagram of the Bit-Interleaved Coded Modulation (BICM) block is shown in Figure 6.1. The BICM block consists of three parts: The Forward Error Correction (FEC), the Bit Interleaver and the Mapper. The BICM block operates per PLP.

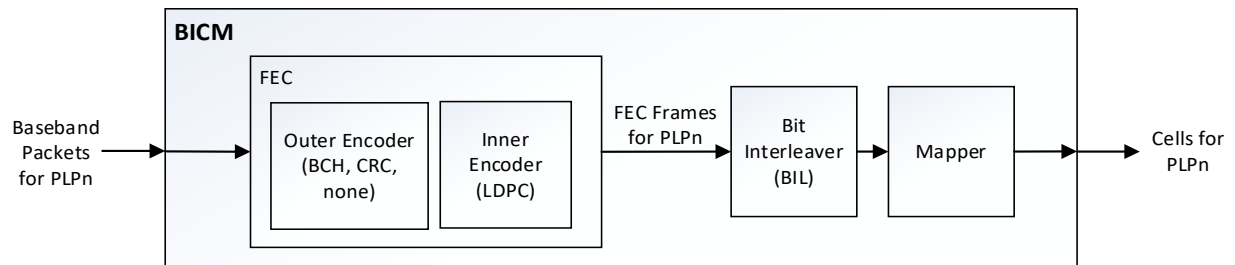

Figure 6.1 Block diagram of BICM.

6.1 Forward Error Correction (FEC)

The input to the FEC part is a Baseband Packet and the output is a FEC Frame. The construction of the FEC Frame is described in Section 6.1.1, with the details of the forward error correction described in Sections 6.1.2 and 6.1.3. It should be noted that the size of the input Baseband Packet depends on the inner code rate and length and outer code type. The size of the FEC Frame depends on the code length only.

6.1.1 FEC Frame Structure

A FEC Frame shall be formed by the concatenation of the Baseband Packet payload, an Outer Code and an Inner Code. The FEC Frame has size N_{inner} , expressed in bits, where the size comes from the length of the Inner Code.

The Inner Code shall be a Low Density Parity Check (LDPC) code. There are two different sizes of LDPC code defined: $N_{inner}=64800$ bits and $N_{inner}=16200$ bits. The use of one of the defined Inner Codes is mandatory and is used to provide the redundancy needed for correct reception of transmitted Baseband Packets. The length of the Inner Code parity M_{inner} depends on the code rate as well as N_{inner} . The choice of Inner Code type is signaled together with the Outer Code type using the **L1D_plp_fec_type** field.

There are three options for the Outer Code: Bose, Ray-Chaudhuri and Hocquenghem (BCH) Outer Code, a Cyclic Redundancy Check (CRC) or none. The Outer Code (BCH and CRC) adds M_{outer} parity bits to the input Baseband Packet. When using BCH codes the length of M_{outer} shall be 192 bits (for $N_{inner}=64800$ bit codes) and 168 bits (for $N_{inner}=16200$ bit codes), respectively. When using CRC the length of M_{outer} shall be 32 bits. The resulting structure of the concatenation of the payload, BCH or CRC parities and LDPC parities is defined as shown in Figure 6.2.

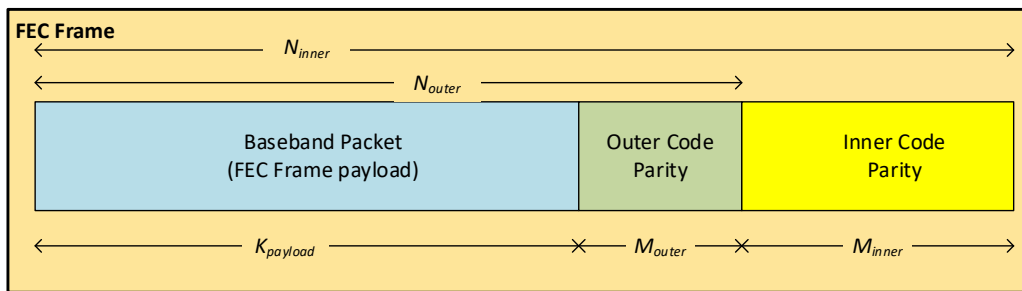

Figure 6.2 Structure of FEC Frame when BCH or CRC is used as Outer Code.

When neither BCH nor CRC is used the length of M_{outer} is zero, and the structure of the FEC Frame is as shown in Figure 6.3.

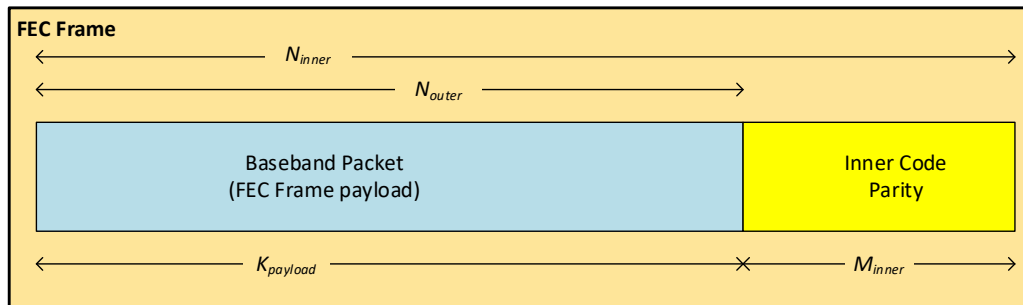

Figure 6.3 Structure of FEC Frame when no Outer Code is used.

The size of $K_{payload}$ therefore, depends on the type of Outer Code used in addition to the code rate and Inner Code length. The size of $K_{payload}$, as well as M_{outer} , M_{inner} and N_{outer} are shown in Table 6.1 and Table 6.2.

Table 6.1 Length of $K_{payload}$ (bits) for $N_{inner} = 64800$

Code Rate	$K_{payload}$ (BCH)	M_{outer} (BCH)	$K_{payload}$ (CRC)	M_{outer} (CRC)	$K_{payload}$ (no outer)	M_{outer} (no outer)	M_{inner}	N_{outer}
2/15	8448	192	8608	32	8640	0	56160	8640
3/15	12768	192	12928	32	12960	0	51840	12960
4/15	17088	192	17248	32	17280	0	47520	17280
5/15	21408	192	21568	32	21600	0	43200	21600
6/15	25728	192	25888	32	25920	0	38880	25920
7/15	30048	192	30208	32	30240	0	34560	30240
8/15	34368	192	34528	32	34560	0	30240	34560
9/15	38688	192	38848	32	38880	0	25920	38880
10/15	43008	192	43168	32	43200	0	21600	43200
11/15	47328	192	47488	32	47520	0	17280	47520
12/15	51648	192	51808	32	51840	0	12960	51840
13/15	55968	192	56128	32	56160	0	8640	56160

Table 6.2 Length of $K_{payload}$ (bits) for $N_{inner} = 16200$

Code Rate	$K_{payload}$ (BCH)	M_{outer} (BCH)	$K_{payload}$ (CRC)	M_{outer} (CRC)	$K_{payload}$ (no outer)	M_{outer} (no outer)	M_{inner}	N_{outer}
2/15	1992	168	2128	32	2160	0	14040	2160
3/15	3072	168	3208	32	3240	0	12960	3240
4/15	4152	168	4288	32	4320	0	11880	4320
5/15	5232	168	5368	32	5400	0	10800	5400
6/15	6312	168	6448	32	6480	0	9720	6480
7/15	7392	168	7528	32	7560	0	8640	7560
8/15	8472	168	8608	32	8640	0	7560	8640
9/15	9552	168	9688	32	9720	0	6480	9720
10/15	10632	168	10768	32	10800	0	5400	10800
11/15	11712	168	11848	32	11880	0	4320	11880
12/15	12792	168	12928	32	12960	0	3240	12960
13/15	13872	168	14008	32	14040	0	2160	14040

6.1.2 Outer Encoding

There are multiple choices for the Outer Code. The first is the BCH code and it provides additional error correction as well as error detection. The second is the use of a CRC, which provides no additional error correction, only error detection. As a third option, no Outer Code may be selected.

6.1.2.1 BCH

When BCH is used for the Outer Code, 12-bit correctable BCH codes are used. These are determined as follows:

Let $m(x) = m_0x^{K_{payload}-1} + m_1x^{K_{payload}-2} + \dots + m_{K_{payload}-1}$ be an information polynomial, whose coefficients $m_0, m_1, \dots, m_{K_{payload}-1}$ are information to be encoded, and let $g(x)$ be the generator polynomial of degree M_{outer} for BCH code where $g(x) = g_1(x)g_2(x)\dots g_{12}(x)$. Then code bits $s_0, s_1, \dots, s_{N_{outer}-1}$ shall be induced as coefficients of a codeword polynomial of degree $N_{outer}-1$, $s(x) = s_0x^{N_{outer}-1} + s_1x^{N_{outer}-2} + \dots + s_{N_{outer}-1} = m(x)x^{M_{outer}} - p(x)$, where $p(x)$ is the residue polynomial of $m(x)x^{M_{outer}}/g(x)$. The definitions of component polynomials $g_i(x)$ for each mode are shown in Table 6.3.

Table 6.3 BCH Polynomials

	Code Length $N_{inner}=64800$	Code Length $N_{inner}=16200$
$g_1(x)$	$x^{16}+x^5+x^3+x^2+1$	$x^{14}+x^5+x^3+x+1$
$g_2(x)$	$x^{16}+x^8+x^6+x^5+x^4+x+1$	$x^{14}+x^{11}+x^8+x^6+1$
$g_3(x)$	$x^{16}+x^{11}+x^{10}+x^9+x^8+x^7+x^5+x^4+x^3+x^2+1$	$x^{14}+x^{10}+x^9+x^6+x^2+x+1$
$g_4(x)$	$x^{16}+x^{14}+x^{12}+x^{11}+x^9+x^6+x^4+x^2+1$	$x^{14}+x^{12}+x^{10}+x^8+x^7+x^4+1$
$g_5(x)$	$x^{16}+x^{12}+x^{11}+x^{10}+x^9+x^8+x^5+x^3+x^2+x+1$	$x^{14}+x^{13}+x^{11}+x^9+x^8+x^6+x^4+x^2+1$
$g_6(x)$	$x^{16}+x^{15}+x^{14}+x^{13}+x^{12}+x^{10}+x^9+x^8+x^7+x^5+x^4+x^2+1$	$x^{14}+x^{13}+x^9+x^8+x^7+x^3+1$
$g_7(x)$	$x^{16}+x^{15}+x^{13}+x^{11}+x^{10}+x^9+x^8+x^6+x^5+x^2+1$	$x^{14}+x^{13}+x^{11}+x^{10}+x^7+x^6+x^5+x^2+1$
$g_8(x)$	$x^{16}+x^{14}+x^{13}+x^{12}+x^9+x^8+x^6+x^5+x^2+x+1$	$x^{14}+x^{11}+x^{10}+x^9+x^8+x^5+1$
$g_9(x)$	$x^{16}+x^{11}+x^{10}+x^9+x^7+x^5+1$	$x^{14}+x^{10}+x^9+x^3+x^2+x+1$
$g_{10}(x)$	$x^{16}+x^{14}+x^{13}+x^{12}+x^{10}+x^8+x^7+x^5+x^2+x+1$	$x^{14}+x^{12}+x^{11}+x^9+x^6+x^3+1$
$g_{11}(x)$	$x^{16}+x^{13}+x^{12}+x^{11}+x^9+x^5+x^3+x^2+1$	$x^{14}+x^{12}+x^{11}+x^4+1$
$g_{12}(x)$	$x^{16}+x^{12}+x^{11}+x^9+x^7+x^6+x^5+x+1$	$x^{14}+x^{13}+x^{10}+x^8+x^7+x^6+x^5+x^3+x^2+x+1$

6.1.2.2 CRC

When a CRC is used for the Outer Code, a 32-bit CRC shall be used. The CRC shall be computed as illustrated in Figure 6.4 and shall implement a feedback shift register characterized by the CRC code polynomial. The generator polynomial of degree n $G_{crc}(x)$ can be expressed as:

$$G_{crc}(x) = x^n + g_{n-1}x^{n-1} + g_{n-2}x^{n-2} + \dots + g_2x^2 + g_1x + 1$$

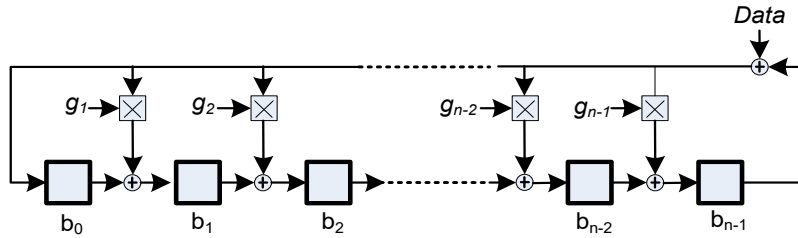

Figure 6.4 Shift register for CRC-32.

Computation of the CRC-32 can be carried out using a shift register circuit such as shown in Figure 6.4. At the beginning of the computation (before the first data bit is input) all register stage contents shall be initialized to one. After applying the first bit (MSB first) of the data block to the input, the shift clock causes the register to shift its contents by one stage towards b_{n-1} while loading the tapped stages with the result of the appropriate operations. After the last data bit of the block is input, the contents of the register stages are read out to provide the 32 CRC bits $\{b_i, i = 0, 1 \dots 31\}$ that shall then be appended to the data prior to inner encoding. The appended bits shall be ordered from the most significant bit (b_{31}) to the least significant bit (b_0). For the CRC-32 used, all values of $g_i = 0$ except for: g_{21} , g_{16} , g_{11} which shall have a value of one. Thus the actual generator polynomial shall be:

$$G_{crc}(x) = x^{32} + x^{21} + x^{16} + x^{11} + 1$$

6.1.2.3 Selection of Outer Code Configuration

The BCH Outer Code is used to lower any potential LDPC error floor by correcting a predefined number of bit errors. For the BCH codes chosen up to 12 bit errors may be corrected. BCH code provides both improved error correction as well as error detection. For improved efficiency, at the cost of no additional error correction, the CRC may be chosen. CRC provides only error detection. Finally, the Outer Code may be omitted if it is determined that the error correcting capability of the Inner Code is sufficient for the application; however, no additional error correction or detection is provided in this case.

6.1.3 Inner Encoding

LDPC codes are used to create parity bits which are appended to the payload in each Baseband Packet. Cyclic-structured LDPC codes are employed. The indices list for each encoding can be found in Annex A.

There are two different coding structures used. These are called Type A (defined in Section 6.1.3.1) and Type B (defined in Section 6.1.3.2). The type used for each code rate and code length shall be as shown in Table 6.4. Type A has a code structure that shows better performance at low code rates while Type B code structure shows better performance at high code rates.

Table 6.4 Structure of LDPC Encoding Used for Each of the Code Rates and Lengths

Code Rate	LDPC Code Structure Type	
	$N_{inner}=64800$	$N_{inner}=16200$
2/15	A	A
3/15	A	A
4/15	A	A
5/15	A	A
6/15	B	B
7/15	A	B
8/15	B	B
9/15	B	B
10/15	B	B
11/15	B	B
12/15	B	B
13/15	B	B

6.1.3.1 Type A LDPC Encoding

Type A LDPC encoding shall be realized as follows.

An LDPC code is used to encode the information block $S = (s_0, s_1, \dots, s_{N_{outer}-1})$. To generate a codeword $\Lambda = (\lambda_0, \lambda_1, \dots, \lambda_{N_{inner}-1})$ of length $N_{inner} = N_{outer} + M_1 + M_2$, the parity bits before parity interleaving $P = (p_0, p_1, \dots, p_{M_1+M_2-1})$ are calculated from S. Then for any i from 0 to $N_{outer} - 1$, λ_i is set equal to s_i , since the code is systematic.

M_1 and M_2 are parity lengths corresponding to a dual diagonal matrix and an identity matrix, respectively. The parity lengths depending on code rates shall be used as specified in Table 6.5 and Table 6.6. The detailed procedure to calculate parity bits shall be as follows:

- i) Initialize $\lambda_i = s_i$ for $i = 0, 1, \dots, N_{outer} - 1$

$$p_j = 0 \text{ for } j = 0, 1, \dots, M_1 + M_2 - 1$$

Accumulate the first information bit, λ_0 , at parity bit addresses specified in the first row of the tables in Annex A (Table A.1.1 to Table A.1.4, Table A.1.6, Table A.2.1 to Table A.2.4).

- ii) For the next 359 information bits $\lambda_m, m = 1, 2, \dots, 359$, accumulate λ_m at parity bit addresses, which are calculated as follows:

$$(x + m \times Q_1) \bmod M_1 \quad \text{if } x < M_1$$

$$M_1 + \{(x - M_1 + m \times Q_2)\} \bmod M_2 \quad \text{if } x \geq M_1$$

where x denotes the address of the parity bit accumulator corresponding to the first bit λ_0 . $Q_1 = M_1/360$ and $Q_2 = M_2/360$ are code rate dependent constants specified in Table 6.5 and Table 6.6.

- iii) For the 361st information bit λ_{360} , the addresses of the parity bit accumulators are given in the second row of the tables in Annex A. In a similar manner, the addresses of the parity bit accumulators for the following 359 information bits $\lambda_m, m = 361, 362, \dots, 719$ are obtained using the equation in step (ii) where x denotes the address of the parity bit accumulator corresponding to the information bit λ_{360} , i.e. the entries in the second row of the tables in Annex A.
- iv) In a similar manner, for every group of 360 new information bits, a new row from the tables in Annex A is used to find the addresses of the parity bit accumulators.
- v) After the codeword bits from λ_0 to $\lambda_{N_{outer}-1}$ are exhausted, sequentially perform the following operations starting with $i = 1$.

$$p_i = p_i \oplus p_{i-1} \text{ for } i = 1, 2, \dots, M_1 - 1$$

- vi) The parity bits from $\lambda_{N_{outer}}$ to $\lambda_{N_{outer}+M_1-1}$, which correspond to the dual diagonal matrix, are obtained using the following interleaving operation:

$$\lambda_{N_{outer}+360 \cdot t+s} = p_{Q_1 \cdot s+t} \text{ for } 0 \leq s < 360, 0 \leq t < Q_1$$

- vii) For every group of 360 new codeword bits from $\lambda_{N_{outer}}$ to $\lambda_{N_{outer}+M_1-1}$, a new row from the tables in Annex A and the equation in step (ii) are used to find the addresses of the parity bit accumulators.
- viii) After the codeword bits from $\lambda_{N_{outer}}$ to $\lambda_{N_{outer}+M_1-1}$ are exhausted, the parity bits from $\lambda_{N_{outer}+M_1}$ to $\lambda_{N_{outer}+M_1+M_2-1}$, which correspond to the identity matrix, are obtained using the following interleaving operation:

$$\lambda_{N_{outer}+M_1+360 \cdot t+s} = p_{M_1+Q_2 \cdot s+t} \text{ for } 0 \leq s < 360, 0 \leq t < Q_2$$

Note that the parity bits from $\lambda_{N_{outer}}$ to $\lambda_{N_{outer}+M_1-1}$ are obtained according to steps (i) to (vi), and then the parity bits from $\lambda_{N_{outer}+M_1}$ to $\lambda_{N_{outer}+M_1+M_2-1}$ are obtained using the results of steps (i) to (vi) according to steps (vii) to (viii).

Table 6.5 Coding Parameters for Type A: $N_{inner} = 64800$

Code Rate	Sizes			
	M_1	M_2	Q_1	Q_2
2/15	1800	54360	5	151
3/15	1800	50040	5	139
4/15	1800	45720	5	127
5/15	1440	41760	4	116
7/15	1080	33480	3	93

Table 6.6 Coding Parameters for Type A: $N_{inner} = 16200$

Code Rate	Sizes			
	M_1	M_2	Q_1	Q_2
2/15	3240	10800	9	30
3/15	1080	11880	3	33
4/15	1080	10800	3	30
5/15	720	10080	2	28

6.1.3.2 Type B LDPC Encoding

Type B LDPC encoding shall be realized as follows.

Let $s_0, s_1, \dots, s_{N_{outer}-1}$ be information bits to be encoded and $\lambda_0, \lambda_1, \dots, \lambda_{N_{inner}-1}$ be code bits to be calculated. Then for any k from 0 to $N_{outer}-1$, λ_k shall be set equal to s_k , since the code is systematic. For the remaining code bits, set $\lambda_{N_{outer}+k} = p_k$ ($0 \leq k < M_{inner}$) and these parity bits p_k shall be calculated as follows. In the following, $q(i, j, 0)$ denotes the j -th entry in the i -th row in the indices list, see Annex A, and $q(i, j, l) = q(i, j, 0) + Q_{ldpc} \cdot l \pmod{M_{inner}}$ for $0 < l < 360$, and all accumulations are realized by additions in GF(2). Q_{ldpc} shall be defined as in Table 6.7.

- i) Initialize $p_k = 0$ for $0 \leq k < M_{inner}$.
- ii) For $0 \leq k < N_{outer}$, set $i = \lfloor k/360 \rfloor$, and $l = k \pmod{360}$. Now accumulate s_k to $p_{q(i, j, l)}$ for all j :

$$p_{q(i, 0, l)} = p_{q(i, 0, l)} + s_k, p_{q(i, 1, l)} = p_{q(i, 1, l)} + s_k, p_{q(i, 2, l)} = p_{q(i, 2, l)} + s_k, \dots, p_{q(i, w(i)-1, l)} = p_{q(i, w(i)-1, l)} + s_k,$$
 where $w(i)$ is the number of elements in the i -th row in the indices list in Annex A.
- iii) For all $0 < k < M_{inner}$, $p_k = p_k + p_{k-1}$.

From these steps, all code bits $\lambda_0, \lambda_1, \dots, \lambda_{N_{inner}-1}$ shall be obtained.

Table 6.7 Coding Parameters for Type B

Code Rate	$Q_{ldpc} (N_{inner}=64800)$	$Q_{ldpc} (N_{inner}=16200)$
6/15	108	27
7/15	N/A	24
8/15	84	21
9/15	72	18
10/15	60	15
11/15	48	12
12/15	36	9
13/15	24	6

6.1.3.3 Tradeoffs

$N_{inner} = 16200$ bit LDPC codes have lower latency but worse performance. In general, $N_{inner} = 64800$ bit codes are expected to be the first choice due to superior performance, however, for applications where latency is critical, or a simpler encoder / decoder structure is preferred, $N_{inner} = 16200$ bit LDPC codes should be used.

6.2 Bit Interleavers

The bit interleaver block takes a FEC Frame as input. The output of the bit interleaver block is a bit-interleaved FEC Frame. The size of the FEC Frame does not change after the bit interleaving operation.

The bit interleaver block consists of a parity interleaver followed by a group-wise interleaver followed by a Block Interleaver. A block diagram giving the bit interleaver internal structure is shown in Figure 6.5.

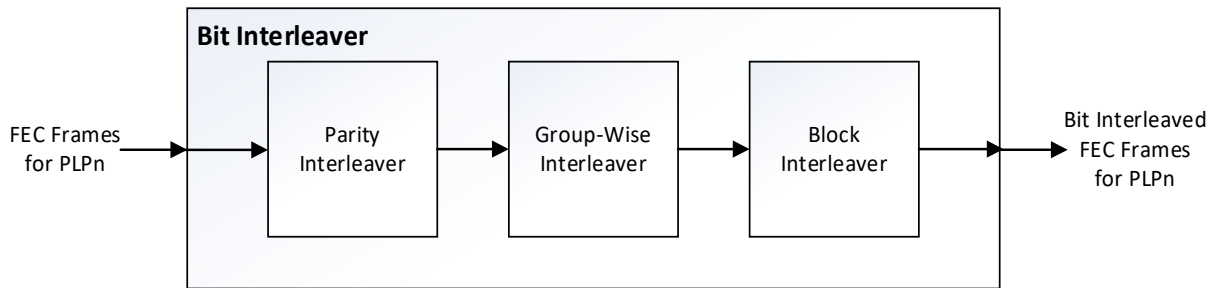

Figure 6.5 Bit interleaver structure.

The parity interleaver is described in Section 6.2.1, the group-wise interleaver in Section 6.2.2 and the Block Interleaver in Section 6.2.3, respectively.

6.2.1 Parity Interleaver

The parity interleaver shall be used for Type B codes only, and shall not be used for Type A codes.

The parity interleaver output is denoted by $U = (u_0, u_1, \dots, u_{N_{inner}-1})$. In the parity interleaver, parity bits shall be interleaved as:

$$u_i = \lambda_i \quad \text{for } 0 \leq i < N_{outer} \text{ (information bits are not interleaved)}$$

$$u_{N_{outer}+360t+s} = \lambda_{N_{outer}+Q_{ldpc}s+t} \quad \text{for } 0 \leq s < 360, 0 \leq t < Q_{ldpc}$$

where Q_{ldpc} is defined in Table 6.7.

The role of the parity interleaver is to convert the staircase structure of the parity-part of the LDPC parity-check matrix into a quasi-cyclic structure similar to the information-part of the matrix.

6.2.2 Group-Wise Interleaver

The parity interleaved LDPC coded bits, $(u_0, u_1, \dots, u_{N_{inner}-1})$, shall be split into $N_{group} = N_{inner} / 360$ bit groups as follows:

$$X_j = \{u_k | 360 \times j \leq k < 360 \times (j + 1), 0 \leq k < N_{inner}\} \quad 0 \leq j < N_{group}$$

where X_j represents the j -th bit group. For $0 \leq j < N_{\text{group}}$, each bit group X_j has 360 bits, as illustrated in Figure 6.6.

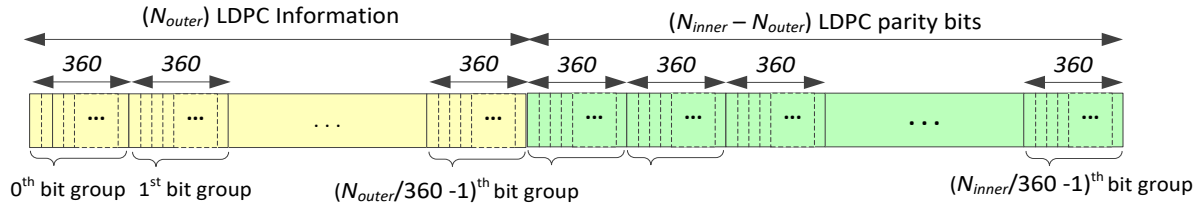

Figure 6.6 Parity interleaved LDPC codeword bit groups.

The parity-interleaved LDPC codeword shall be interleaved by the group-wise interleaver as follows:

$$Y_j = X_{\pi(j)} \text{ for } 0 \leq j < N_{\text{group}}$$

where Y_j represents the group-wise interleaved j -th bit group and $\pi(j)$ denotes the permutation order for group-wise interleaving. The corresponding group-wise interleaving is optimized for each combination of modulation and LDPC code rate. Table series in B.1 and B.2 in Annex B show the permutation order of the group-wise interleaving $\pi(j)$ for code lengths $N_{\text{inner}} = 64800$ and $N_{\text{inner}} = 16200$, respectively.

The group-wise interleaved LDPC codeword denoted by $(v_0, v_1, \dots, v_{N_{\text{inner}}-1})$ is the concatenation of Y_j as follows:

$$V = \{Y_0, Y_1, \dots, Y_{N_{\text{group}}-1}\}$$

6.2.3 Block Interleavers

There are Type A and Type B Block Interleavers for each Type A and Type B FEC and constellation combination. Note that some Type A FEC and constellation combinations use a Type A Block Interleaver while other Type A FEC and constellation combinations use a Type B Block Interleaver, and similarly for Type B FEC and constellation combinations and Type A and Type B Block Interleavers. That is, Type A FEC and constellation combinations are not necessarily always paired with a Type A Block Interleaver, and Type B FEC and constellation combinations are not necessarily always paired with a Type B Block Interleaver. The Block Interleaver type shall be as defined in Table 6.8 and Table 6.9. Type A Block Interleaver is described in Section 6.2.3.1 and Type B Block Interleaver is described in Section 6.2.3.2.

Table 6.8 Block Interleaver Type for Codes of Length $N_{inner}=64800$ Bits

CR MOD	2/15	3/15	4/15	5/15	6/15	7/15	8/15	9/15	10/15	11/15	12/15	13/15
2	A	A	A	A	A	A	A	A	A	A	A	A
4	A	A	A	B	A	A	B	B	A	A	A	A
6	A	A	A	A	A	B	A	B	B	A	A	B
8	A	A	A	B	B	B	B	A	B	B	A	B
10	A	A	A	B	A	B	A	B	B	B	A	A
12	A	A	A	A	A	B	A	A	A	A	A	A

Table 6.9 Block Interleaver Type for Codes of Length $N_{inner}=16200$ Bits

CR MOD	2/15	3/15	4/15	5/15	6/15	7/15	8/15	9/15	10/15	11/15	12/15	13/15
2	A	A	A	A	B	B	A	B	A	A	A	A
4	A	A	A	A	B	B	A	B	A	B	A	B
6	A	A	A	A	B	B	A	B	A	A	A	A
8	A	A	A	A	B	A	A	A	A	B	A	A

6.2.3.1 Type A Block Interleaver

Following the group-wise interleaver, the LDPC codeword shall be interleaved by the Block Interleaver as shown in Figure 6.7. Each column of the Type A Block Interleaver shall be composed of a first part and a second part. Part 1 and Part 2 are divided based on the number of columns of the Block Interleaver and the number of bits of the bit group. In Part 1, the bits constituting the bit group shall be written in the same column. In Part 2, the bits constituting the bit group shall be written in at least two columns.

The data bits v_i from the group-wise interleaver shall be written serially into the Block Interleaver column-wise starting in Part 1 and continuing column-wise finishing in Part 2, and shall then be read out serially row-wise from Part 1 and then row-wise from Part 2, as shown in Figure 6.7. Therefore, the bits from the same group in Part 1 shall be mapped onto the bits having the same bit position in each modulation symbol.

Part 1 and Part 2 block interleaving configurations for each modulation format and code length shall be as specified in Table 6.10. The number of columns of the Block Interleaver is equal to the number of bits constituting a modulation symbol. The sum of N_{r1} and N_{r2} is equal to N_{inner}/N_c , and N_{r1} ($=\lfloor N_{group}/N_c \rfloor \times 360$) is a multiple of 360, so that multiple bit groups are written into Part 1 of Block Interleaver.

Table 6.10 Type A Block Interleaver Configurations

Modulation	Rows in Part 1 N_{r1}		Rows in Part 2 N_{r2}		Columns N_c
	$N_{inner} = 64800$	$N_{inner} = 16200$	$N_{inner} = 64800$	$N_{inner} = 16200$	
QPSK	32400	7920	0	180	2
16QAM	16200	3960	0	90	4
64QAM	10800	2520	0	180	6
256QAM	7920	1800	180	225	8
1024QAM	6480	N/A	0	N/A	10
4096QAM	5400	N/A	0	N/A	12

The Block Interleaver is described as follows:

The input bit v_i with index i , for $0 \leq i < N_c \times N_{r1}$, shall be written to column c_i , row r_i of Part 1 in the interleaver, where:

$$c_i = \left\lfloor \frac{i}{N_{r1}} \right\rfloor$$

$$r_i = (i \bmod N_{r1})$$

and then the input bit v_i with index i , for $N_c \times N_{r1} \leq i < N_{inner}$, shall be written to column c_i , row r_i of Part 2 in the interleaver, where:

$$c_i = \left\lfloor \frac{(i - N_c \times N_{r1})}{N_{r2}} \right\rfloor$$

$$r_i = N_{r1} + \{(i - N_c \times N_{r1}) \bmod N_{r2}\}$$

The output bit q_j with index j , for $0 \leq j < N_{inner}$, shall be read from row r_j , column c_j , where:

$$r_j = \left\lfloor \frac{j}{N_c} \right\rfloor$$

$$c_j = (j \bmod N_c)$$

As an example, for 256QAM and $N_{inner} = 64800$, the output bit order of block interleaving would be:

$$(q_0, q_1, q_2, \dots, q_{63357}, q_{63358}, q_{63359}, q_{63360}, q_{63361}, \dots, q_{64799}) = \\ (v_0, v_{7920}, v_{15840}, \dots, v_{47519}, v_{55439}, v_{63359}, v_{63360}, v_{63540}, \dots, v_{64799}).$$

A longer list of the indices on the right hand side, illustrating all 8 columns, is: 0, 7920, 15840, 23760, 31680, 39600, 47520, 55440, 1, 7921, 15841, 23761, 31681, 39601, 47521, 55441, , 7919, 15839, 23759, 31679, 39599, 47519, 55439, 63359, 63360, 63540, 63720, 63900, 64080, 64260, 64440, 64620, , 63539, 63719, 63899, 64079, 64259, 64439, 64619, 64799.

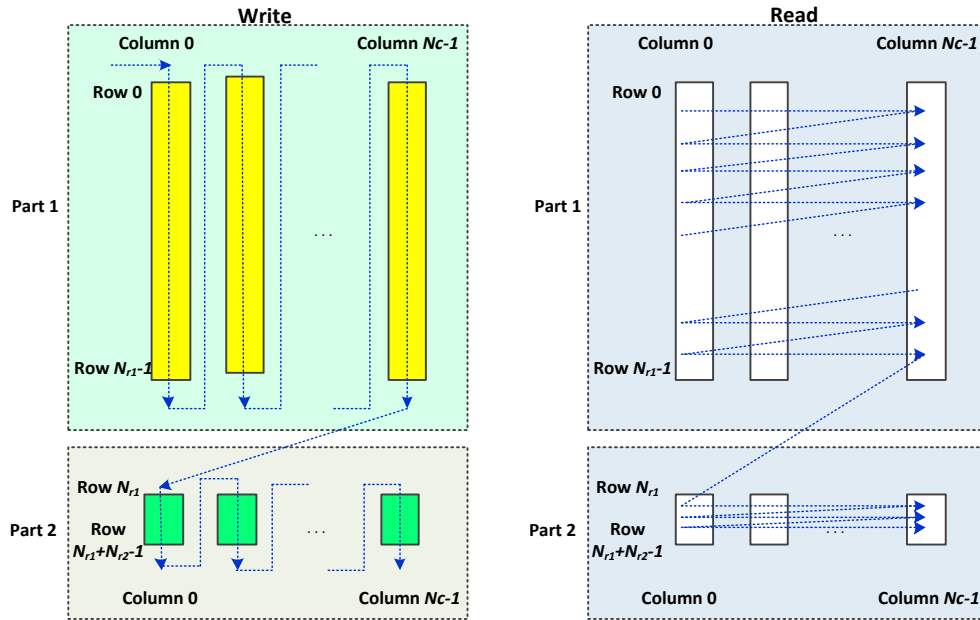

Figure 6.7 Write/Read operation of Type A block interleaving.

6.2.3.2 Type B Block Interleaver

After the group-wise interleaving, Type B block interleaving shall be performed using the parameter N_{QCB_IG} which is defined according to modulation order as shown in Table 6.11. Type B block interleaving consists of Part 1 and Part 2 processes. N_{part1} and N_{part2} refer to the number of bits processed in Part 1 and Part 2, respectively.

Table 6.11 Parameters for Type B Block Interleaver

Modulation	N_{QCB_IG}	N_{part1}		N_{part2}	
		$N_{inner} = 64800$	$N_{inner} = 16200$	$N_{inner} = 64800$	$N_{inner} = 16200$
QPSK	2	64800	15840	0	360
16QAM	4	64800	15840	0	360
64QAM	6	64800	15120	0	1080
256QAM	8	63360	14400	1440	1800
1024QAM	10	64800	N/A	0	N/A
4096QAM	12	64800	N/A	0	N/A

For Part 1, the Type B block interleaving process shall be performed with each set of N_{QCB_IG} bit groups of the group-wise interleaver output. Part 1 process shall consist of writing and reading the bits of the N_{QCB_IG} bit groups using 360 columns and N_{QCB_IG} rows. In the write operation, bits from the group-wise interleaver output shall be written row-wise as illustrated in the example of Figure 6.8. The read operation shall be performed column-wise to read out 1 bit from each row and an example is shown in Figure 6.9. Note that the Part 1 process is performed on the first bit through the N_{part1} -th bit defined in Table 6.11.

For Part 2, the remaining bits excluded from the repeated operation in Part 1 (i.e. N_{part2} bits) shall be mapped to symbols sequentially without performing block interleaving.

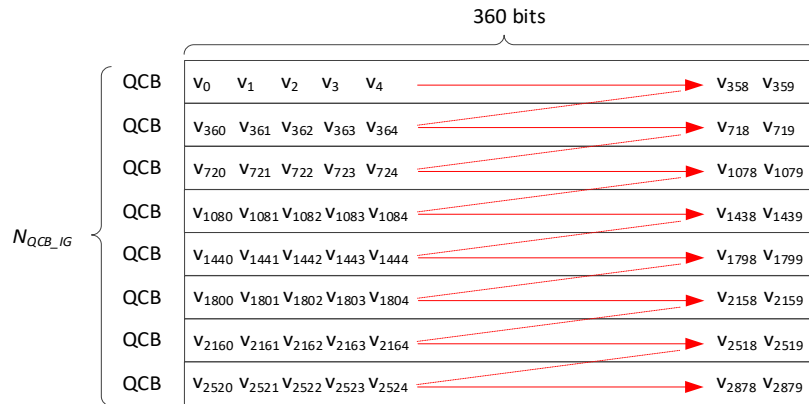

Figure 6.8 Write operation of Part 1 Type B block interleaving for 256QAM.

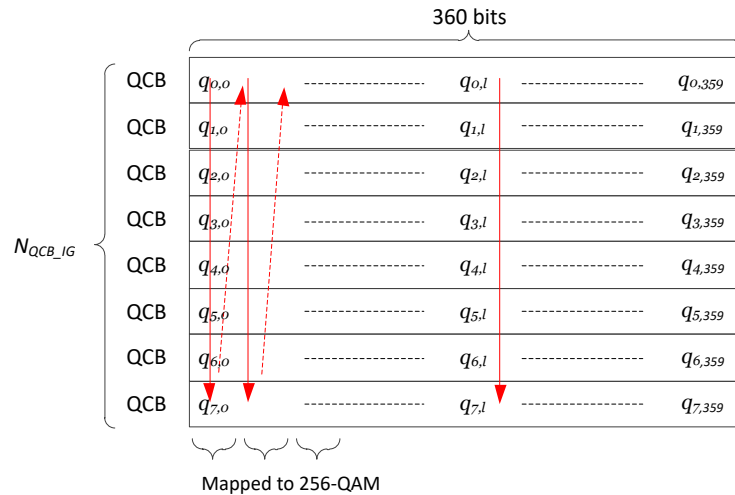

Figure 6.9 Read operation of Part 1 Type B block interleaving for 256QAM.

6.3 Constellation Mapping

This section describes the mapping of FEC encoded and bit-interleaved bits to complex valued quadrature amplitude modulation (QAM) constellation points on the IQ plane. The input to the constellation mapping block is a stream of bit-interleaved FEC Frames and the output is cells, grouped as a FEC Block when necessary.

The Mapper consists of a DeMultiplexer block that is followed by a bit-to-IQ mapping block. A block diagram of the Mapper is shown in Figure 6.10. The following sections describe the details to map the input FEC Frame bits to the constellation. First, the bits comprising a FEC Frame shall be demultiplexed into parallel streams as described in Section 6.3.3 to generate data cells. Next the data cells shall be mapped to constellation values, this is described in Section 6.3.4. The details for each type of modulation are described in Section 6.3.4.1 for QPSK, Section 6.3.4.2 for 16QAM to 256QAM and Section 6.3.4.3 for 1024 and 4096 QAM.

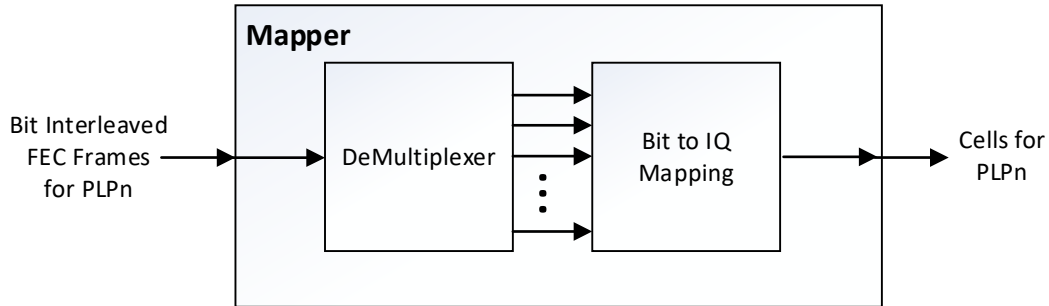

Figure 6.10 Mapper structure.

6.3.1 Constellation Overview

Six different modulation orders are defined: uniform QPSK modulation and five non-uniform constellation (NUC) sizes; 16QAM, 64QAM, 256QAM, 1024QAM and 4096QAM respectively. For each combination of NUC modulation order and code rate a different constellation exists. However, the constellation does not vary with code length, the same constellation is used for both $N_{inner}=64800$ and $N_{inner}=16200$ codes when the code rate and modulation order are held constant. The same QPSK constellation is used for all code rates.

The QPSK constellation is a 1-dimensional QAM form.

The non-uniform constellations 16QAM, 64QAM and 256QAM are 2-dimensional (2D) quadrant-symmetric QAM constellations and are constructed by symmetry from a single quadrant. To reduce the complexity during QAM de-mapping at the receiver, the 1024QAM and 4096QAM constellations are derived from non-uniform 1-dimensional (1D) PAM (pulse amplitude modulation) constellations for both in-phase (I) and quadrature (Q) components.

6.3.2 Modulation and Coding Combinations

In order to reduce the implementation complexity, implementation of all the modulation and coding combinations is not mandatory. Table 6.12 and Table 6.13 show the mandatory modulation and coding combinations that must be implemented. Mandatory combinations are shown with a check mark ✓.

Table 6.12 Mandatory Modulation and Coding Combinations $N_{inner} = 64800$ Bits

Code Rate/ Constellation	2/ 15	3/ 15	4/ 15	5/ 15	6/ 15	7/ 15	8/ 15	9/ 15	10/ 15	11/ 15	12/ 15	13/ 15
QPSK	✓	✓	✓	✓	✓	✓	✓	✓		✓		
16QAM			✓	✓		✓	✓	✓		✓		
64QAM		✓	✓	✓	✓	✓	✓	✓	✓	✓		
256QAM			✓	✓		✓	✓	✓	✓	✓	✓	✓
1024QAM				✓		✓	✓	✓	✓	✓	✓	✓
4096QAM						✓		✓		✓	✓	✓

Table 6.13 Mandatory Modulation and Coding Combinations $N_{inner} = 16200$ Bits

Code Rate/ Constellation	2/ 15	3/ 15	4/ 15	5/ 15	6/ 15	7/ 15	8/ 15	9/ 15	10/ 15	11/ 15	12/ 15	13/ 15
QPSK	✓	✓	✓	✓	✓	✓	✓	✓				
16QAM				✓	✓	✓	✓			✓		
64QAM				✓	✓	✓	✓	✓	✓	✓		
256QAM				✓		✓	✓	✓	✓	✓	✓	✓

6.3.3 Demultiplexing Operation

The operation to map bits from each FEC Frame to parallel streams before constellation mapping is known as demultiplexing. The number of output data cells for each FEC Frame input and the effective number of bits per cell η_{MOD} is defined in Table 6.14.

Table 6.14 Parameters for Bit-Mapping into Constellations

Modulation	η_{MOD}	No. output data cells $N_{inner} = 64800$ bits	No. output data cells $N_{inner} = 16200$ bits
QPSK	2	32400	8100
16QAM	4	16200	4050
64QAM	6	10800	2700
256QAM	8	8100	2025
1024QAM	10	6480	N/A
4096QAM	12	5400	N/A

The bit-stream q_j from the output of the block-interleaver within the bit interleaver shall be demultiplexed into η_{MOD} sub-streams, as shown in Figure 6.11. The output of the de-multiplexer is a vector denoted as $(y_{0,s}, \dots, y_{\eta_{MOD}-1,s})$, with the first index describing the bit-level position, and the index s describing the discrete time index for enumerating all output data cells for one FEC Block.

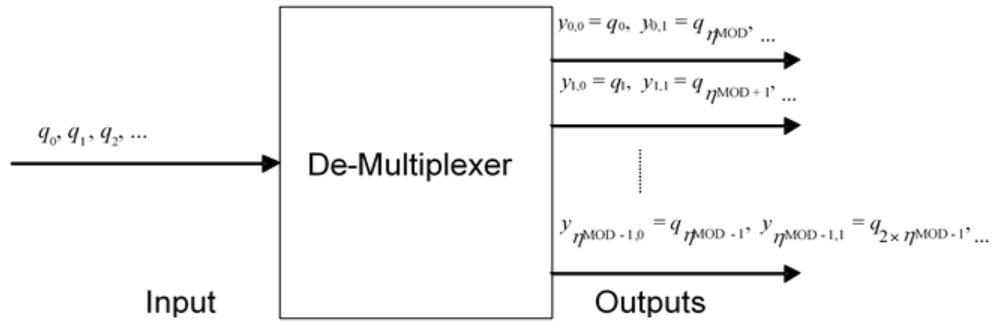

Figure 6.11 De-multiplexing of bits into sub-streams.

6.3.4 Bit to IQ Mapping

6.3.4.1 QPSK

The same constellation mapping for QPSK shall be used for all code rates.

A two-bit input $(y_{0,s}, y_{1,s})$ shall be mapped to data cells following the mapping in Table C.1.1, where the first column represents the bits $(y_{0,s}, y_{1,s})$ and the second column represents the cell value at the output of the constellation mapper.

6.3.4.2 16QAM, 64QAM and 256QAM

For 16QAM, 64QAM and 256QAM, each input data cell word $(y_{0,s}, \dots, y_{\eta_{MOD}-1,s})$ shall be modulated using a 2D non-uniform constellation to give a constellation point z_s . Index s denotes the discrete time index, and η_{MOD} is the number of bits per constellation symbol as defined in Table 6.14.

The vector of complex constellation points $\mathbf{x} = (x_0, \dots, x_{M-1})$ includes all M constellation points of the QAM alphabet. The k -th element of this vector, \mathbf{x}_k , corresponds to the QAM constellation point for the input cell word $(y_{0,s}, \dots, y_{\eta_{MOD}-1,s})$, if these bits take on the decimal number k ($y_{0,s}$ being the most significant bit (MSB), and $y_{\eta_{MOD}-1,s}$ being the least significant bit (LSB)). Due to the quadrant symmetry, the complete vector \mathbf{x} shall be derived by defining just the first quarter of the complex constellation points, i.e., $(x_0, \dots, x_{M/4-1})$, which corresponds to the first quadrant. The generation rule for the remaining points shall be as described below. Defining $b = M/4$, the first quarter of complex constellation points shall be denoted as the NUC position vector $\mathbf{w} = (w_0, \dots, w_{b-1})$, where the position vectors are defined in Table C.1.2 to Table C.1.7.

As an example, the NUC position vector for 16QAM comprises the complex constellation points with the labels corresponding to the decimal values 0, i.e., $(y_{0,s}, \dots, y_{\eta_{MOD}-1,s}) = 0000$, to $b-1$, i.e., $(y_{0,s}, \dots, y_{\eta_{MOD}-1,s}) = 0011$. The remaining constellation points are derived as follows:

$$\begin{aligned}
 (x_0, \dots, x_{b-1}) &= \mathbf{w} && \text{(first quarter)} \\
 (x_b, \dots, x_{2b-1}) &= -\text{conj}(\mathbf{w}) && \text{(second quarter)} \\
 (x_{2b}, \dots, x_{3b-1}) &= \text{conj}(\mathbf{w}) && \text{(third quarter)} \\
 (x_{3b}, \dots, x_{4b-1}) &= -\mathbf{w} && \text{(fourth quarter),}
 \end{aligned}$$

with conj being the complex conjugate.

6.3.4.2.1 Example

The NUC position vector for 16QAM and code rate 6/15 is constructed as follows. From Table C.1.2 $\mathbf{w} = (0.5115+j1.2092, 1.2092+j0.5115, 0.2663+j0.4530, 0.4530+j0.2663)$. Here and in the

following, $j=\sqrt{-1}$ is the imaginary unit. Assuming the input data cell word is $(y_{0,s}, \dots, y_{\eta_{MOD}-1,s}) = (1100)$, the corresponding QAM constellation point at time index s is $z_s = x_{12} = -w_0 = -0.5115 - j1.2092$. The complete constellation for this NUC position vector is shown in Figure 6.12 with all input data cells marked at the corresponding constellation points.

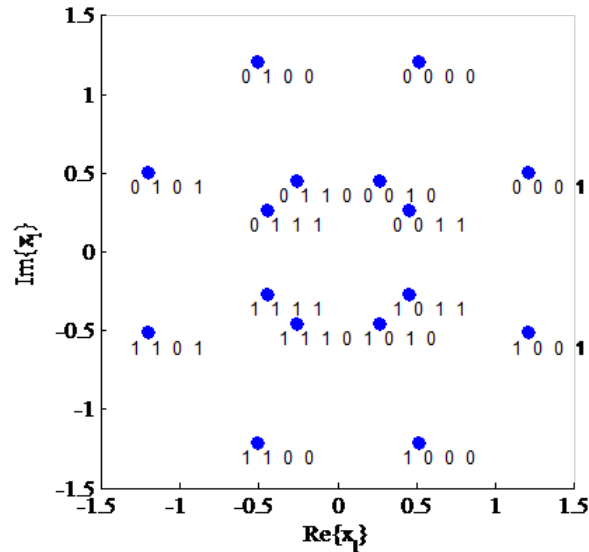

Figure 6.12 Example 16-NUC for code rate 6/15.

6.3.4.3 1024QAM and 4096QAM

For 1024QAM and 4096QAM each input data cell word $(y_{0,s}, \dots, y_{\eta_{MOD}-1,s})$ at discrete time index s shall be modulated using a 1-dimensional non-uniform QAM constellation to give a constellation point z_s prior to normalization. 1-dimensional refers to the fact that a 2-dimensional QAM constellation can be separated into two 1-dimensional PAM constellations, one for each I and Q component. The exact values of the real and imaginary components $\text{Re}(z_s)$ and $\text{Im}(z_s)$ for each combination of the relevant input cell word $(y_{0,s}, \dots, y_{\eta_{MOD}-1,s})$ shall be given by a 1D-NUC position vector $\mathbf{u} = (u_0, \dots, u_{v-1})$, where the position vectors are defined in Table C.1.8 to Table C.1.11 and the bit labels are defined in Table C.3.1 to Table C.3.4. Vector \mathbf{u} defines the constellation point positions of the non-uniform constellation in one dimension. The number of elements of the 1D-NUC position vector \mathbf{u} is defined by

$$v = \frac{\sqrt{M}}{2}$$

6.3.4.3.1 Example

The 1024-NUC for code rate 6/15 is defined by the NUC position vector from Table C.1.8, where $\mathbf{u} = (u_0, \dots, u_{15}) = (0.1275, 0.1276, 0.1294, 0.1295, 0.3424, 0.3431, 0.3675, 0.3666, 0.6097, 0.6072, 0.7113, 0.7196, 0.9418, 1.0048, 1.2286, 1.5031)$. Assuming the input data cell $(y_{0,s}, \dots, y_{\eta_{MOD}-1,s}) = (0010011100)$ the corresponding QAM constellation point z_s has $\text{Im}(z_s) = u_3 = 0.1295$ (defined by even index bit labels, i.e., 01010) and $\text{Re}(z_s) = u_{11} = 0.7196$ (defined by odd index bit label, i.e., 00110). The complete constellation for this NUC position vector is shown in Figure 6.13.

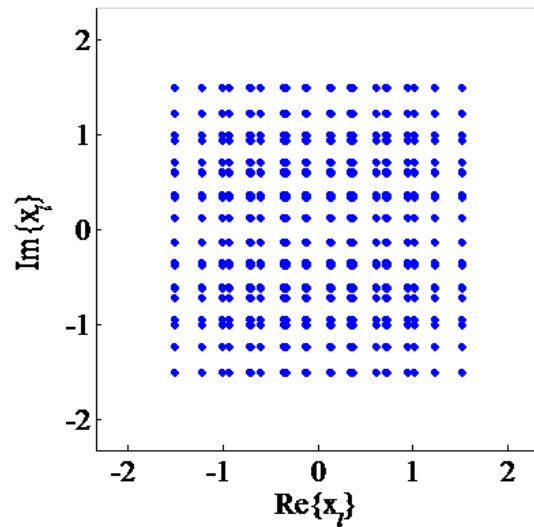

Figure 6.13 Example 1024-NUC for code rate 6/15.

6.4 Layered Division Multiplexing (LDM)

LDM is a constellation superposition technology that combines multiple PLPs at different power levels, often with different modulation and channel coding schemes, before transmission in one RF channel.

In this version of the specification only two-layer LDM is defined. The two layers shall be called Core Layer and Enhanced Layer, respectively.

6.4.1 LDM Encoding

The block diagram of the encoding of a two-layer LDM system is shown in Figure 6.14.

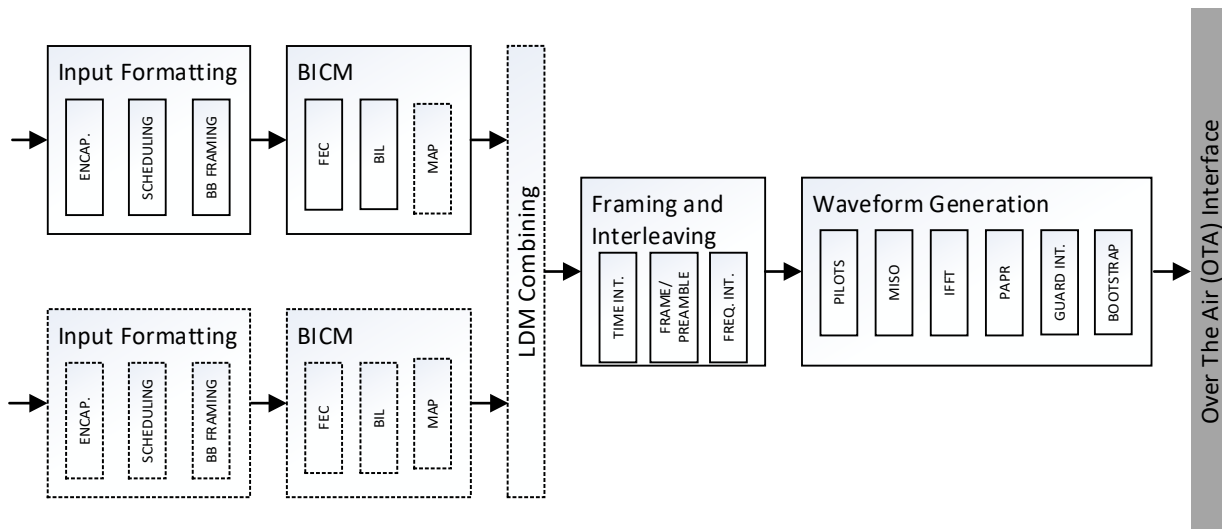

Figure 6.14 Block diagram of LDM encoding.

A two-layer LDM system shall combine two or more PLPs before time interleaving. Each layer shall consist of one or more PLPs. The Core Layer shall have equal or greater robustness than the

Enhanced Layer. Each PLP may use a different FEC encoding (including code length and code rate) and constellation mapping. For example the Core Layer might use $N_{inner}=64800$, code rate=4/15 and QPSK while the Enhanced Layer might use $N_{inner}=64800$, code rate=10/15 and 64QAM.

The Core PLPs and Enhanced PLPs shall be combined in an LDM Combiner block, depicted in Figure 6.15 .

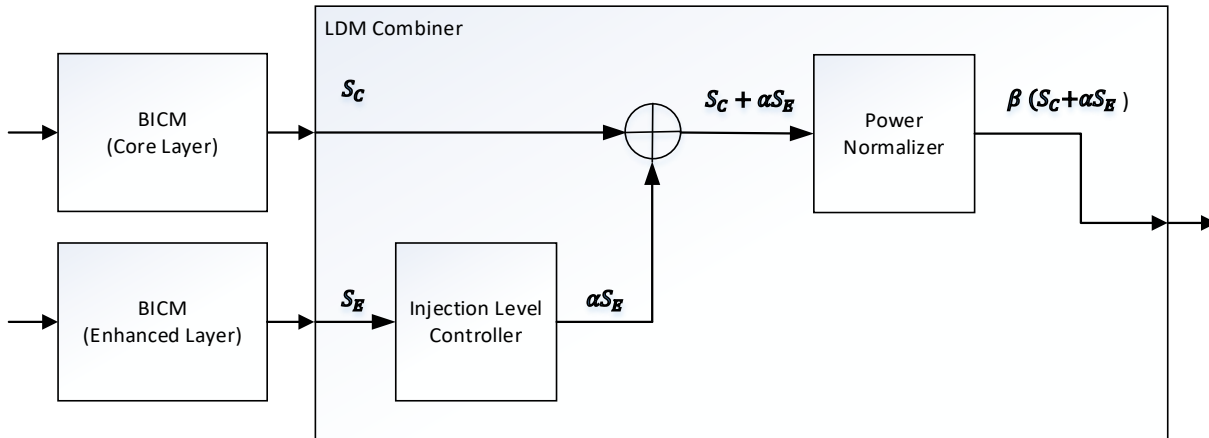

Figure 6.15 Constellation superposition for two-layer LDM.

An injection level controller shall be used to reduce the power of the Enhanced Layer relative to the Core Layer so as to output the desired transmission energy for each layer. The transmission energy level shall be chosen in combination with the ModCod parameters in order to achieve the desired coverage area as well as the desired bit rate. The Enhanced Layer injection levels relative to the Core Layer are selectable from 0 dB to 25 dB below the Core Layer.

6.4.2 Injection Level Controller

The injection level (of the Enhanced Layer signal relative to the Core Layer signal) is a transmission parameter which enables distribution of transmission power between the two layers. By varying the injection level, the transmission robustness of each layer is changed, providing an additional method of varying robustness in addition to the choice of ModCod parameters for each PLP. The dedicated power distributions for each layer according to the various allowed injection levels are listed in Table 6.15.

Table 6.15 Power Distributions Between Layers for Various Injection Levels

Injection level of EL below CL level (dB)	CL power ratio relative to total power (%)	EL power ratio relative to total power (%)	Reduction of CL power relative to total power (dB)	Reduction of EL power relative to total power (dB)
0.0 dB	50.0%	50.0%	3.01	3.01
+0.5 dB	52.9%	47.1%	2.77	3.27
+1.0 dB	55.7%	44.3%	2.54	3.54
+1.5 dB	58.5%	41.5%	2.32	3.82
+2.0 dB	61.3%	38.7%	2.12	4.12
+2.5 dB	64.0%	36.0%	1.94	4.44
+3.0 dB	66.6%	33.4%	1.76	4.76
+3.5 dB	69.1%	30.9%	1.60	5.10

Injection level of EL below CL level (dB)	CL power ratio relative to total power (%)	EL power ratio relative to total power (%)	Reduction of CL power relative to total power (dB)	Reduction of EL power relative to total power (dB)
+4.0 dB	71.5%	28.5%	1.46	5.46
+4.5 dB	73.8%	26.2%	1.32	5.82
+5.0 dB	76.0%	24.0%	1.19	6.19
+6.0 dB	79.9%	20.1%	0.97	6.97
+7.0 dB	83.4%	16.6%	0.79	7.79
+8.0 dB	86.3%	13.7%	0.64	8.64
+9.0 dB	88.8%	11.2%	0.51	9.51
+10.0 dB	90.9%	9.1%	0.41	10.41
+11.0 dB	92.6%	7.4%	0.33	11.33
+12.0 dB	94.1%	5.9%	0.27	12.27
+13.0 dB	95.2%	4.8%	0.21	13.21
+14.0 dB	96.2%	3.8%	0.17	14.17
+15.0 dB	96.9%	3.1%	0.14	15.14
+16.0 dB	97.5%	2.5%	0.11	16.11
+17.0 dB	98.0%	2.0%	0.09	17.09
+18.0 dB	98.4%	1.6%	0.07	18.07
+19.0 dB	98.8%	1.2%	0.05	19.05
+20.0 dB	99.0%	1.0%	0.04	20.04
+21.0 dB	99.2%	0.8%	0.03	21.03
+22.0 dB	99.4%	0.6%	0.03	22.03
+23.0 dB	99.5%	0.5%	0.02	23.02
+24.0 dB	99.6%	0.4%	0.02	24.02
+25.0 dB	99.7%	0.3%	0.01	25.01

6.4.3 Power Normalizer

After combining the total power of combined signals shall be normalized to unity in the power normalizer block.

The value of the scaling factor of the injection level controller, α , and the normalizing factor of the power normalizer, β , depends on the injection level of the Enhanced Layer. Values allowed are listed in Table 6.16.

Table 6.16 Scaling and Normalizing Factors According to Enhanced Layer Injection Level

Injection level of EL below CL level (dB)	Scaling factor α	Normalizing factor β	Injection level of EL below CL level (dB)	Scaling factor α	Normalizing factor β
0.0 dB	1.0000000	0.7071068	+11.0 dB	0.2818383	0.9625032
+0.5 dB	0.9440609	0.7271524	+12.0 dB	0.2511886	0.9698706
+1.0 dB	0.8912509	0.7465331	+13.0 dB	0.2238721	0.9758449
+1.5 dB	0.8413951	0.7651789	+14.0 dB	0.1995262	0.9806699
+2.0 dB	0.7943282	0.7830305	+15.0 dB	0.1778279	0.9845540
+2.5 dB	0.7498942	0.8000406	+16.0 dB	0.1584893	0.9876723
+3.0 dB	0.7079458	0.8161736	+17.0 dB	0.1412538	0.9901705
+3.5 dB	0.6683439	0.8314061	+18.0 dB	0.1258925	0.9921685
+4.0 dB	0.6309573	0.8457262	+19.0 dB	0.1122018	0.9937642

Injection level of EL below CL level (dB)	Scaling factor α	Normalizing factor β	Injection level of EL below CL level (dB)	Scaling factor α	Normalizing factor β
+4.5 dB	0.5956621	0.8591327	+20.0 dB	0.1000000	0.9950372
+5.0 dB	0.5623413	0.8716346	+21.0 dB	0.0891251	0.9960519
+6.0 dB	0.5011872	0.8940022	+22.0 dB	0.0794328	0.9968601
+7.0 dB	0.4466836	0.9130512	+23.0 dB	0.0707946	0.9975034
+8.0 dB	0.3981072	0.9290819	+24.0 dB	0.0630957	0.9980154
+9.0 dB	0.3548134	0.9424353	+25.0 dB	0.0562341	0.9984226
+10.0 dB	0.3162278	0.9534626			

6.4.4 LDM Example

An example for LDM illustrating a constellation for each of the Core and Enhanced Layers and the resulting constellation after combination and normalization is shown in Figure 6.16 and Figure 6.17.

In this example, the Core Layer uses the code rate 4/15 and QPSK modulation as shown in Figure 6.16(a), and the Enhanced Layer uses the code rate 10/15 and 64-QAM modulation as shown in Figure 6.16(b). The injection level of the Enhanced Layer below the Core Layer is set to 4 dB, where the scaling factors for power normalization are $\alpha = 0.6309573$ and $\beta = 0.8457262$, respectively. The power ratio of the Core Layer relative to the total power is 71.5% whereas the power ratio of the Enhanced Layer relative to the total power is 28.5%. The resulting combined constellation is shown in Figure 6.17.

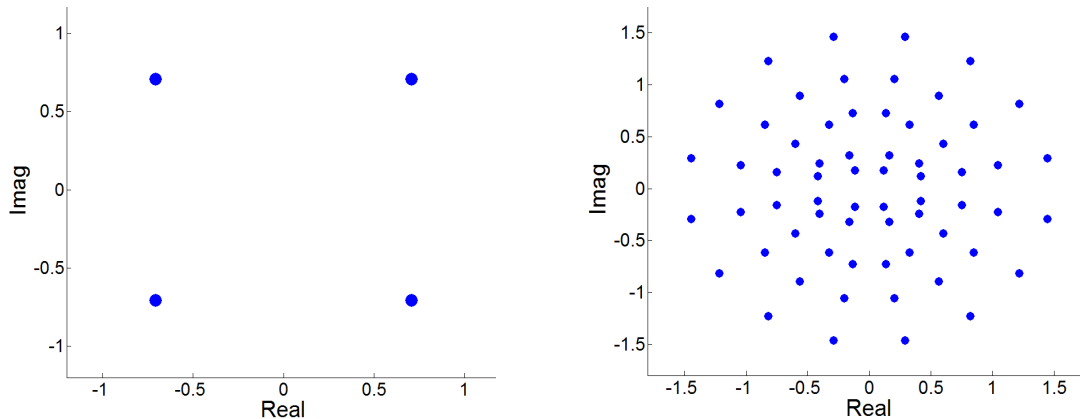

Figure 6.16 Examples of (a, left) Core Layer and (b, right) Enhanced Layer constellations.

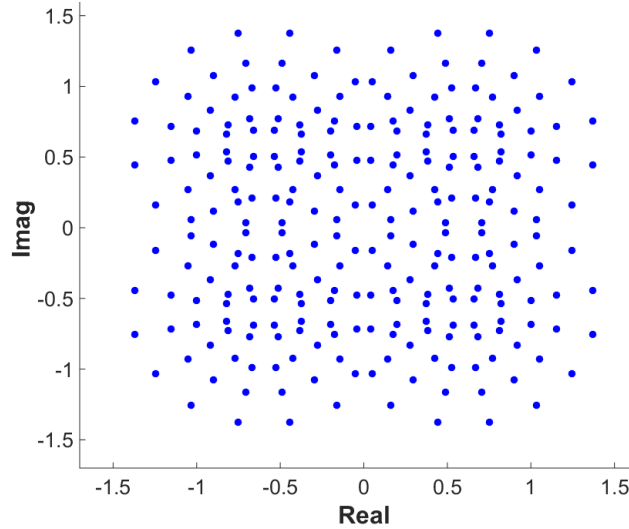

Figure 6.17 Example combined constellation after normalization.

6.5 Protection for L1 Signaling

6.5.1 Overview

There are two separate L1 data sections that are input to the framing block to be inserted into the Preamble, L1-Basic data and L1-Detail data. This data shall be protected using the separate encoding methods detailed below. The input to the L1-Basic protection block is the 200 bits of L1-Basic information described in Section 9.2 while the input to the L1-Detail protection block is the variable number of data bits described in Section 9.3. The outputs of the L1-Basic and L1-Detail protection blocks are used in the construction of the Preamble (see Section 7.2.5).

Many of the blocks in L1-Basic and L1-Detail protection are common, these blocks are described in Section 6.5.2. Specific blocks used only for L1-Detail protection are described in Section 6.5.3.

The complete encoding chain of the L1-Basic signaling is shown in Figure 6.18.

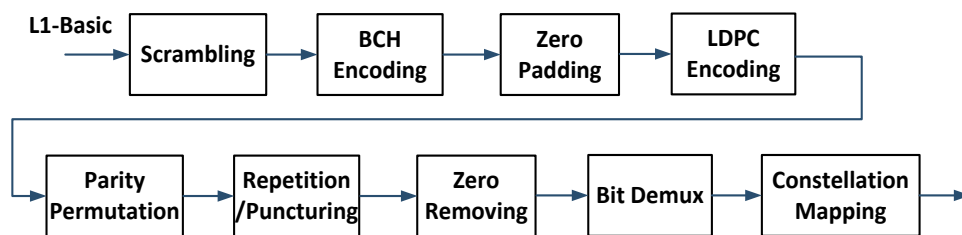

Figure 6.18 Block diagram of L1-Basic protection.

With reference to Figure 6.18, Scrambling details are described in Section 6.5.2.2, BCH encoding is described in Section 6.5.2.3, Zero padding (or shortening) is described in Section 6.5.2.4, LDPC encoding is described in Section 6.5.2.5, Parity permutation in Section 6.5.2.6, Repetition in Section 6.5.2.7 and Parity Puncturing in Section 6.5.2.8, Zero removal is described in Section 6.5.2.9, Bit Demuxing in Section 6.5.2.10 and Constellation Mapping is described in Section 6.5.2.11.

The complete encoding chain of the L1-Detail signaling is shown in Figure 6.19.

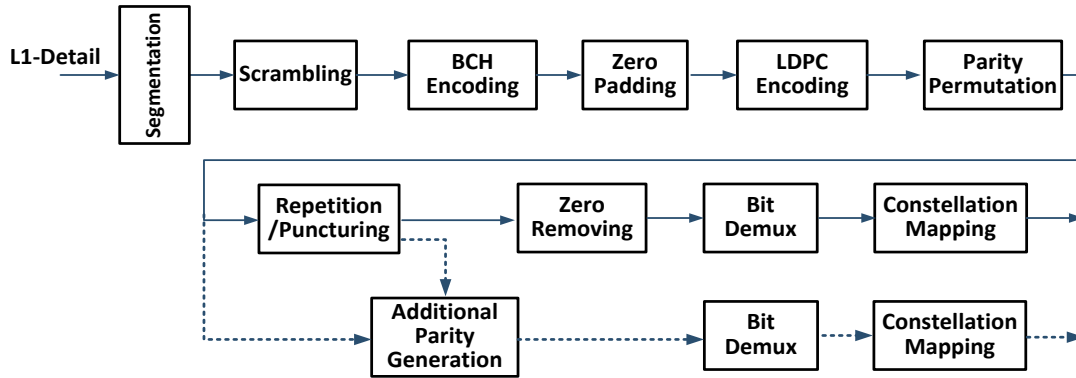

Figure 6.19 Block diagram of the L1-Detail protection.

The details of the L1-Detail specific blocks shown in Figure 6.19 are as follows. Segmentation details are defined in Section 6.5.3.1 and Additional Parity details are defined in Section 6.5.3.2.

6.5.2 Common Blocks for L1-Basic and L1-Detail

6.5.2.1 Overview of Common Blocks

The L1-Basic and L1-Detail signaling are protected by a concatenation of BCH Outer Code and LDPC Inner Code. They shall be first scrambled and then BCH-encoded, where the BCH parity-check bits of the L1-Basic and L1-Detail signaling shall be appended to the L1-Basic and L1-Detail signaling bits, respectively. The concatenated signaling and BCH parity-check bits are further protected by a shortened and punctured 16K LDPC code, as described in sections 6.5.2.8 and 6.5.2.9. When required, repetition is applied before puncturing, as described in Section 6.5.2.7.

To provide various robustness levels suitable for wide SNR range, the protection level of L1-Basic and L1-Detail signaling is categorized into 7 modes based on LDPC codes, modulation order and shortening/puncturing parameter, i.e., a ratio of the number of bits to be punctured to the number of bits to be shortened. Each categorized mode employs a distinct combination of LDPC code, modulation order and constellation and shortening/puncturing pattern.

Table 6.17 presents the ModCod configurations for the 7 modes each of L1-Basic and L1-Detail. The 16K LDPC codes and non-uniform constellations used for L1 signaling protection shall be the same as those for Baseband Packet payload.

K_{sig} means the number of information bits for a coded block, i.e., L1 signaling bits of size K_{sig} correspond to one LDPC coded block. The value of K_{sig} for L1-Basic is fixed as 200, however, the value of K_{sig} for L1-Detail is variable since the amount of L1-Detail signaling bits is variable. Segmentation operation shall be applied to L1-Detail signaling when the number of L1-Detail signaling bits is larger than the maximum value of K_{sig} defined in Table 6.17. Each segmented L1-Detail block of size K_{sig} corresponds to one LDPC coded block. The details of Segmentation are defined in Section 6.5.3.1.

Table 6.17 Configurations for L1-Basic and L1-Detail Signaling

Signaling FEC Type	K_{sig}	Code Length	Code Rate	Constellation	Length (Cells)	
L1-Basic	Mode 1	200	16200	3/15 (Type A)	QPSK	3820
	Mode 2				QPSK	934
	Mode 3				QPSK	484
	Mode 4				NUC_16_8/15	259
	Mode 5				NUC_64_9/15	163
	Mode 6				NUC_256_9/15	112
	Mode 7				NUC_256_13/15	69
L1-Detail	Mode 1	200 ~ 2352	16200	6/15 (Type B)	QPSK	
	Mode 2	200 ~ 3072			QPSK	
	Mode 3	200 ~ 6312			QPSK	
	Mode 4				NUC_16_8/15	
	Mode 5				NUC_64_9/15	
	Mode 6				NUC_256_9/15	
	Mode 7				NUC_256_13/15	

6.5.2.2 Scrambling

Every K_{sig} bits of information shall be scrambled before BCH encoding. The generator polynomial, initialization and operation of the scrambler shall be the same as that of the Baseband Packet scrambler described in Section 5.2.3.

6.5.2.3 BCH Encoding

The systematic BCH code for $N_{inner} = 16200$ defined in Section 6.1.2.1 shall be used for outer encoding of L1-Basic and L1-Detail signaling, followed by zero padding. The parameters for a shortened BCH code are given in Table 6.18.

Table 6.18 Parameters for BCH Encoding of L1 Information

Signaling FEC Type	K_{sig} = $K_{payload}$	M_{outer}	$N_{outer} =$ $K_{sig} + M_{outer}$	
L1-Basic	Mode 1	200	168	368
	Mode 2			
	Mode 3			
	Mode 4			
	Mode 5			
	Mode 6			
	Mode 7			
L1-Detail	Mode 1	200 ~ 2352	368 ~ 2520	
	Mode 2	200 ~ 3072	368 ~ 3240	
	Mode 3	200 ~ 6312	368 ~ 6480	
	Mode 4			
	Mode 5			
	Mode 6			
	Mode 7			

6.5.2.4 Zero Padding

Some of the information bits of the 16K LDPC code shall be padded with zeros in order to fill K_{ldpc} information bits. The padding bits shall not be transmitted. Here, K_{ldpc} is the number of LDPC

encoder input information bits and has the same value of $K_{payload}$ in the case of no Outer Code for $N_{inner}=16200$ in Section 6.1.1.

All K_{ldpc} LDPC information bits, denoted by $\{i_0, i_1, \dots, i_{K_{ldpc}-1}\}$, shall be divided into N_{info_group} ($= K_{ldpc}/360$) groups as follows:

$$Z_j = \left\{ i_k \mid j = \left\lfloor \frac{k}{360} \right\rfloor, 0 \leq k < K_{ldpc} \right\} \text{ for } 0 \leq j < N_{info_group}$$

where Z_j represents the j th bit group. The parameters $(N_{outer}, K_{ldpc}, N_{info_group})$ for L1-Basic and L1-Detail signaling data are given in Table 6.19.

Table 6.19 Parameters for Zero Padding

Signaling FEC Type	N_{outer}	K_{ldpc}	N_{info_group}
L1-Basic (all modes)	368	3240	9
L1-Detail Mode 1	368 ~ 2520		
L1-Detail Mode 2	368 ~ 3240		
L1-Detail Mode 3	368 ~ 6480	6480	18
L1-Detail Mode 4			
L1-Detail Mode 5			
L1-Detail Mode 6			
L1-Detail Mode 7			

For $0 \leq j < N_{info_group}$, each bit group Z_j has 360 bits, as shown in Figure 6.20.

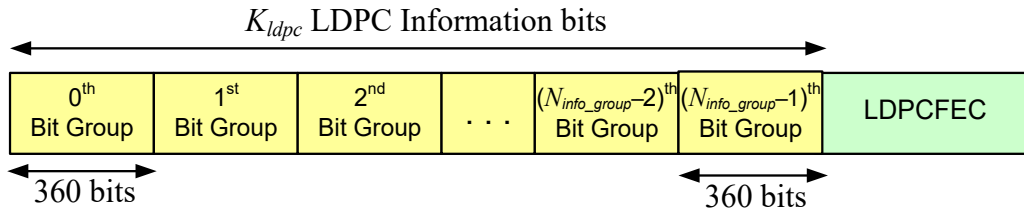

Figure 6.20 Format of data after LDPC encoding of L1-Basic/-Detail signaling.

When the length of BCH encoded bits for L1-Basic and L1-Detail signaling, i.e. $N_{outer}(= K_{sig} + M_{outer}) < K_{ldpc}$, the K_{ldpc} LDPC information bits shall be filled with N_{outer} BCH encoded bits and $(K_{ldpc} - N_{outer})$ zero-padded bits for LDPC encoding.

For the given N_{outer} , the number of zero-padding bits shall be calculated as $(K_{ldpc} - N_{outer})$. Then, the shortening procedure shall be as follows:

Step 1) Compute the number of groups in which all the bits shall be padded, N_{pad} such that

$$N_{pad} = \left\lfloor \frac{K_{ldpc} - N_{outer}}{360} \right\rfloor.$$

Step 2) When N_{pad} is not zero, determine the list of N_{pad} groups, $Z_{\pi_S(0)}, Z_{\pi_S(1)}, \dots, Z_{\pi_S(N_{pad}-1)}$, with $\pi_S(j)$ being the shortening pattern order of the j -th bit group to be as described in Table 6.20. The information bits of the determined groups shall be padded with zeros.

When N_{pad} is zero, then the above procedure shall be skipped.

- Step 3)** For the group $Z_{\pi_S(N_{\text{pad}})}$, $(K_{\text{ldpc}} - N_{\text{outer}} - 360 \times N_{\text{pad}})$ information bits in the first part of $Z_{\pi_S(N_{\text{pad}})}$ shall be additionally padded with zeros.
- Step 4)** Finally, N_{outer} BCH encoded bits shall be sequentially mapped to bit positions which are not padded in K_{ldpc} LDPC information bits, $\{i_0, i_1, \dots, i_{K_{\text{ldpc}}-1}\}$ by the above procedure.

Table 6.20 Shortening Pattern of Information Bit Group to be Padded

Signaling FEC Type	N_{group}	$\pi_S(j)$ ($0 \leq j < N_{\text{group}}$)									
		$\pi_S(0)$	$\pi_S(1)$	$\pi_S(2)$	$\pi_S(3)$	$\pi_S(4)$	$\pi_S(5)$	$\pi_S(6)$	$\pi_S(7)$	$\pi_S(8)$	
		$\pi_S(9)$	$\pi_S(10)$	$\pi_S(11)$	$\pi_S(12)$	$\pi_S(13)$	$\pi_S(14)$	$\pi_S(15)$	$\pi_S(16)$	$\pi_S(17)$	
L1-Basic (for all modes)	9	4	1	5	2	8	6	0	7	3	
		-	-	-	-	-	-	-	-	-	
L1-Detail Mode 1		7	8	5	4	1	2	6	3	0	
		-	-	-	-	-	-	-	-	-	
L1-Detail Mode 2		6	1	7	8	0	2	4	3	5	
		-	-	-	-	-	-	-	-	-	
L1-Detail Mode 3		18	0	12	15	13	2	5	7	9	8
			6	16	10	14	1	17	11	4	3
L1-Detail Mode 4			0	15	5	16	17	1	6	13	11
	4		7	12	8	14	2	3	9	10	
L1-Detail Mode 5	2		4	5	17	9	7	1	6	15	
	8		10	14	16	0	11	13	12	3	
L1-Detail Mode 6	0		15	5	16	17	1	6	13	11	
	4		7	12	8	14	2	3	9	10	
L1-Detail Mode 7	15		7	8	11	5	10	16	4	12	
	3		0	6	9	1	14	17	2	13	

6.5.2.5 LDPC Encoding

The K_{ldpc} output bits ($i_0, i_1, \dots, i_{K_{\text{ldpc}}-1}$) from zero inserter, including the $(K_{\text{ldpc}} - N_{\text{outer}})$ zero padding bits and the $M_{\text{outer}} = (N_{\text{outer}} - K_{\text{sig}})$ BCH parity-check bits constitute the K_{ldpc} information bits $\mathbf{I} = (i_0, i_1, \dots, i_{K_{\text{ldpc}}-1})$ for the LDPC encoder. The LDPC encoder shall systematically encode the K_{ldpc} information bits onto a codeword \mathbf{A} of size N_{inner} : $\mathbf{A} = (c_0, c_1, \dots, c_{N_{\text{inner}}-1}) = (i_0, i_1, \dots, i_{K_{\text{ldpc}}-1}, p_0, p_1, \dots, p_{N_{\text{inner}}-K_{\text{ldpc}}-1})$ according to Section 6.1.3.1 (for all L1-Basic Modes and L1-Detail Modes 1 and 2) or Section 6.1.3.2 (for L1-Detail Modes 3, 4, 5, 6 and 7). The LDPC configurations are given in Table 6.6 and Table 6.7.

6.5.2.6 Parity Permutation

The parity permutation shall be performed only for the parity part (not information part), and the operation shall consist of a parity interleaver and group-wise parity permutation.

Parity interleaving shall be used for L1-Detail Modes 3, 4, 5, 6 and 7 and shall not be used for L1-Basic and L1-Detail Modes 1 and 2, since parity interleaving is already included as part of the LDPC encoding process in these latter modes.

The parity interleaver output is denoted by $\mathbf{U} = (u_0, u_1, \dots, u_{N_{\text{ldpc}}-1})$. In the parity interleaving, parity bits shall be interleaved as:

$$u_i = c_i \quad \text{for } 0 \leq i < K_{ldpc} \text{ (information bits are not interleaved.)}$$

$$u_{K_{ldpc}+360t+s} = c_{K_{ldpc}+27s+t} \quad \text{for } 0 \leq s < 360, 0 \leq t < 27.$$

For L1-Basic and L1-Detail Modes 1 and 2, the parity interleaver is not used. Therefore

$$u_i = c_i \quad \text{for } 0 \leq i < N_{inner}.$$

The parity interleaved LDPC coded bits, $(u_0, u_1, \dots, u_{N_{ldpc}-1})$, shall be split into $N_{group} = N_{ldpc}/360$ bit groups as follows:

$$X_j = \{u_k | 360 \times j \leq k < 360 \times (j+1), 0 \leq k < N_{inner}\} \text{ for } 0 \leq j < N_{group},$$

where X_j represents the j -th bit group. Each bit group X_j has 360 bits, as illustrated in Figure 6.21.

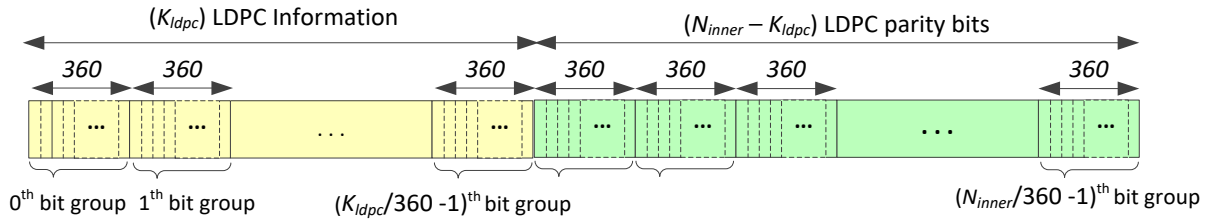

Figure 6.21 Parity interleaved LDPC codeword bit groups.

The information bits among the parity-interleaved LDPC bits shall not be interleaved by the group-wise interleaver while the parity bits among the parity-interleaved LDPC bits shall be interleaved by the group-wise interleaver as follows:

$$Y_j = X_j, \quad 0 \leq j < K_{ldpc}/360$$

$$Y_j = X_{\pi_P(j)}, \quad K_{ldpc}/360 \leq j < N_{group}$$

where Y_j represents the group-wise interleaved j -th bit group and $\pi_P(j)$ denotes the permutation order for group-wise interleaving. LDPC parity bits are arranged such that parity bit groups are arranged in a reverse order of puncturing pattern by parity permutation. Table 6.21 and Table 6.22 show the permutation order of the group-wise interleaving $\pi_P(j)$ for the parity part.

Table 6.21 Group-wise Interleaving Pattern for all L1-Basic Modes, L1-Detail Modes 1 and 2

Signaling FEC Type	N_{group}	Order of Group-Wise Interleaving $\pi_p(j)$ ($9 \leq j < 45$)											
		$\pi_p(9)$	$\pi_p(10)$	$\pi_p(11)$	$\pi_p(12)$	$\pi_p(13)$	$\pi_p(14)$	$\pi_p(15)$	$\pi_p(16)$	$\pi_p(17)$	$\pi_p(18)$	$\pi_p(19)$	$\pi_p(20)$
L1-Basic (all modes)	45	$\pi_p(21)$	$\pi_p(22)$	$\pi_p(23)$	$\pi_p(24)$	$\pi_p(25)$	$\pi_p(26)$	$\pi_p(27)$	$\pi_p(28)$	$\pi_p(29)$	$\pi_p(30)$	$\pi_p(31)$	$\pi_p(32)$
		$\pi_p(33)$	$\pi_p(34)$	$\pi_p(35)$	$\pi_p(36)$	$\pi_p(37)$	$\pi_p(38)$	$\pi_p(39)$	$\pi_p(40)$	$\pi_p(41)$	$\pi_p(42)$	$\pi_p(43)$	$\pi_p(44)$
		20	23	25	32	38	41	18	9	10	11	31	24
14		15	26	40	33	19	28	34	16	39	27	30	
21		44	43	35	42	36	12	13	29	22	37	17	
L1-Detail Mode 1		16	22	27	30	37	44	20	23	25	32	38	41
		9	10	17	18	21	33	35	14	28	12	15	19
		11	24	29	34	36	13	40	43	31	26	39	42
L1-Detail Mode 2		9	31	23	10	11	25	43	29	36	16	27	34
		26	18	37	15	13	17	35	21	20	24	44	12
		22	40	19	32	38	41	30	33	14	28	39	42

Table 6.22 Group-wise Interleaving Pattern for L1-Detail Modes 3, 4, 5, 6 and 7

Signaling FEC Type	N_{group}	Order of Group-Wise Interleaving $\pi_p(j)$ ($18 \leq j < 45$)													
		$\pi_p(18)$	$\pi_p(19)$	$\pi_p(20)$	$\pi_p(21)$	$\pi_p(22)$	$\pi_p(23)$	$\pi_p(24)$	$\pi_p(25)$	$\pi_p(26)$	$\pi_p(27)$	$\pi_p(28)$	$\pi_p(29)$	$\pi_p(30)$	$\pi_p(31)$
L1-Detail Mode 3	45	$\pi_p(32)$	$\pi_p(33)$	$\pi_p(34)$	$\pi_p(35)$	$\pi_p(36)$	$\pi_p(37)$	$\pi_p(38)$	$\pi_p(39)$	$\pi_p(40)$	$\pi_p(41)$	$\pi_p(42)$	$\pi_p(43)$	$\pi_p(44)$	
		19	37	30	42	23	44	27	40	21	34	25	32	29	24
26		35	39	20	18	43	31	36	38	22	33	28	41		
L1-Detail Mode 4		20	35	42	39	26	23	30	18	28	37	32	27	44	43
		41	40	38	36	34	33	31	29	25	24	22	21	19	
L1-Detail Mode 5		19	37	33	26	40	43	22	29	24	35	44	31	27	20
		21	39	25	42	34	18	32	38	23	30	28	36	41	
L1-Detail Mode 6		20	35	42	39	26	23	30	18	28	37	32	27	44	43
		41	40	38	36	34	33	31	29	25	24	22	21	19	
L1-Detail Mode 7		44	23	29	33	24	28	21	27	42	18	22	31	32	37
		43	30	25	35	20	34	39	36	19	41	40	26	38	

6.5.2.7 Repetition

For L1-Basic Mode 1 and L1-Detail Mode 1 only, additional N_{repeat} bits shall be selected from within the encoded LDPC codeword and transmitted. Repetition shall not be performed for any other modes.

The repetition procedure is as follows:

- Step 1)** For a given N_{outer} , the number of parity bits to be additionally transmitted per LDPC codeword, N_{repeat} , shall be calculated by multiplying N_{outer} by a fixed number C and adding an even integer D . The values of C and D shall be selected according to Table 6.23.

$$N_{repeat} = 2 \times [C \times N_{outer}] + D.$$

Table 6.23 Parameters for Repetition

	N_{outer}	K_{sig}	K_{ldpc}	C	D	N_{ldpc_parity} (= $N_{inner} - K_{ldpc}$)	η_{MOD}
L1-Basic Mode 1	368	200	3240	0	+3672	12960	2
L1-Detail Mode 1	368 ~ 2520	200 ~ 2352	3240	61/16	- 508	12960	2

Step 2) If $N_{repeat} \leq N_{ldpc_parity}$, the first N_{repeat} bits of the LDPC parity with parity permutation shall be appended to the LDPC information bits, as shown in Figure 6.22.

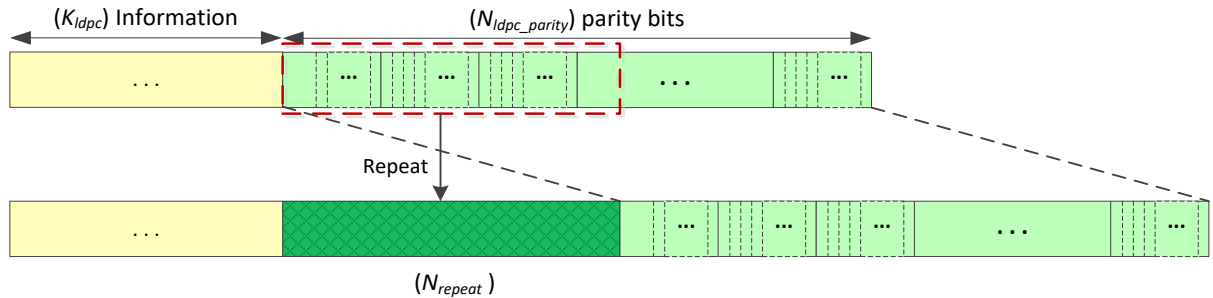
**Figure 6.22** Parity Repetition ($N_{repeat} \leq N_{ldpc_parity}$).

If $N_{repeat} > N_{ldpc_parity}$, the N_{ldpc_parity} bits of the LDPC parity with parity permutation shall be appended to the LDPC information bits and the first $(N_{repeat} - N_{ldpc_parity})$ bits of the LDPC parity with parity permutation shall be additionally appended to the first appended N_{ldpc_parity} bits, as shown in Figure 6.23.

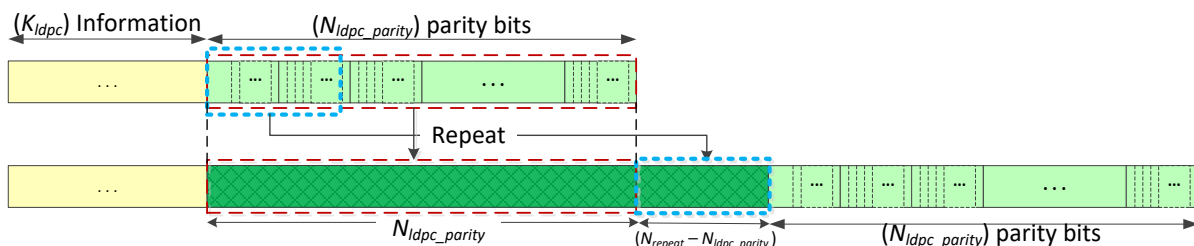
**Figure 6.23** Parity Repetition ($N_{repeat} > N_{ldpc_parity}$).

6.5.2.8 Parity Puncturing

Some LDPC parity bits are punctured after parity permutation. These punctured bits are not transmitted in the Frame carrying the L1 signaling bits.

For a given N_{outer} , the number of parity bits to be punctured per LDPC codeword and the size of one coded block shall be determined as described in the following steps:

Step 1)

$$N_{punc_temp} = \lfloor A \times (K_{ldpc} - N_{outer}) \rfloor + B$$

Depending on the Mode, the temporary size of puncturing bits shall be calculated by multiplying the shortening length by a ratio of the number of bits to be punctured to the number

of bits to be shortened, A , and adding a constant integer B . K_{ldpc} , A and B shall be selected according to Table 6.24.

Table 6.24 Parameters for Puncturing

Signaling FEC Type		N_{outer}	K_{ldpc}	A	B	N_{ldpc_parity}	η_{MOD}
L1-Basic	Mode 1	368	3240	0	9360	12960	2
	Mode 2				11460		2
	Mode 3				12360		2
	Mode 4				12292		4
	Mode 5				12350		6
	Mode 6				12432		8
	Mode 7				12776		8
L1-Detail	Mode 1	368 ~ 2520	6480	7/2	0	9720	2
	Mode 2	368 ~ 3240		2	6036		2
	Mode 3	368 ~ 6480		11/16	4653		2
	Mode 4			29/32	3200		4
	Mode 5			3/4	4284		6
	Mode 6			11/16	4900		8
	Mode 7			49/256	8246		8

Step 2)

$$N_{FEC_temp} = N_{outer} + N_{ldpc_parity} - N_{punc_temp}$$

where the number of LDPC parity bits, N_{ldpc_parity} shall be selected according to Table 6.24.

Step 3)

$$N_{FEC} = \left\lceil \frac{N_{FEC_temp}}{\eta_{MOD}} \right\rceil \times \eta_{MOD},$$

where η_{MOD} denotes the modulation order, which is defined in Table 6.24. N_{FEC} is an integer multiple of the modulation order.

Step 4)

$$N_{punc} = N_{punc_temp} - (N_{FEC} - N_{FEC_temp})$$

where N_{FEC} denotes the total number of encoded bits by BCH and LDPC for each information block.

The last N_{punc} bits of the whole LDPC codeword with parity permutation and repetition shall be punctured as shown in Figure 6.24 and Figure 6.25 when N_{punc} is a positive integer. Note that the repetition is applied only for L1-Basic Mode 1 and L1-Detail Mode 1.

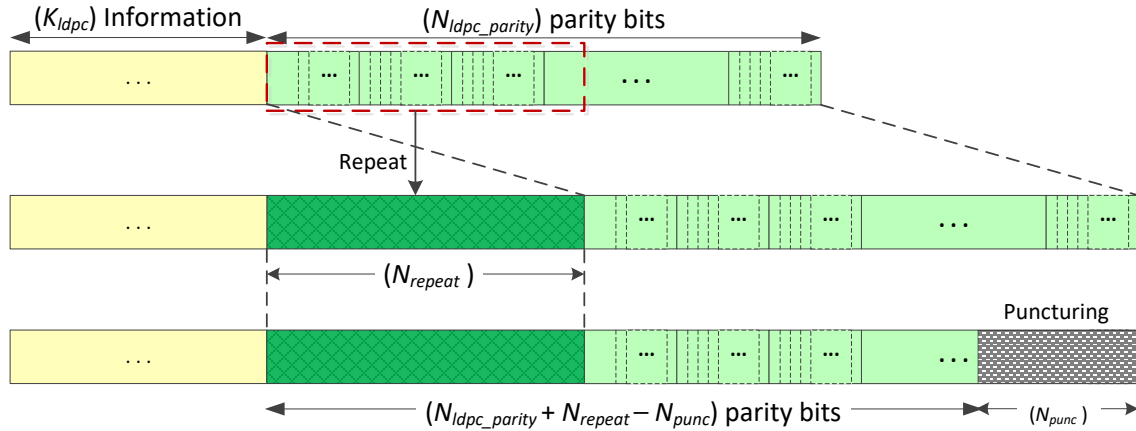

Figure 6.24 Example 1 of parity puncturing after repetition.

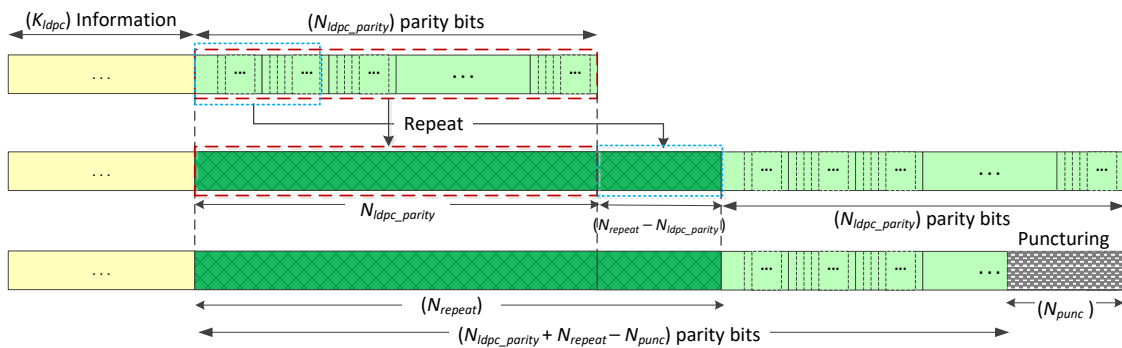

Figure 6.25 Example 2 of parity puncturing after repetition.

6.5.2.9 Zero Removal

The $(K_{ldpc} - N_{outer})$ zero padding bits shall be removed and shall not be transmitted. This leaves a word consisting of the K_{sig} information bits, followed by the 168 BCH parity bits and $(N_{inner} - K_{ldpc} - N_{punc})$ or $(N_{inner} - K_{ldpc} - N_{punc} + N_{repeat})$ parity bits, as illustrated in Figure 6.26. Note that the length of the whole LDPC codeword with repetition is $(N_{FEC} + N_{repeat})$.

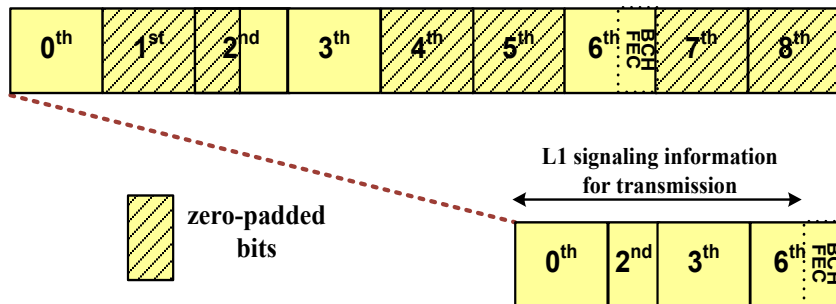

Figure 6.26 Example of removal of zero-padding bits.

6.5.2.10 Bit Demuxing

Following zero padded bit removal, the remaining bits of length N_{FEC} or $(N_{FEC} + N_{repeat})$ shall be written serially into the Block Interleaver column-wise, where the number of columns shall be the same as the modulation order.

In the read operation, the bits for one constellation symbol shall be read out sequentially row-wise and fed into the bit demultiplexer block. These operations shall continue until the end of the column. Figure 6.27 shows the block interleaving process.

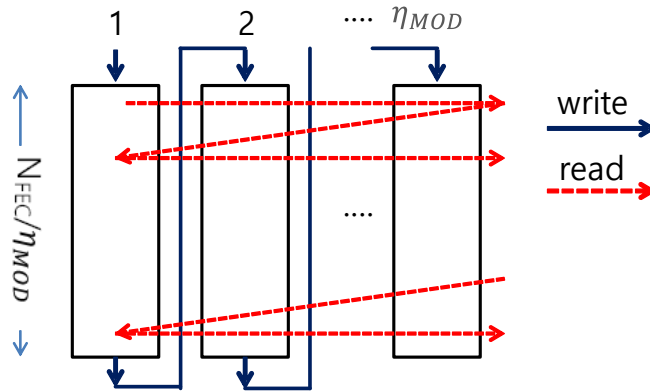

Figure 6.27 Block interleaving scheme.

Each block interleaved group is demultiplexed bit-by-bit in a group before constellation mapping. Depending on modulation order, there are two mapping rules. In the case of QPSK, the reliability of bits in a symbol is equal. Therefore, a bit group read out from the Block Interleaver shall be mapped directly to a QAM symbol without any intervening operation. In the cases of higher order modulations a bit group shall be mapped to a QAM symbol with the rule described as follows:

$$S_{demux_in}(i) = \{b_i(0), b_i(1), b_i(2), \dots, b_i(\eta_{MOD} - 1)\},$$

$$S_{demux_out}(i) = \{c_i(0), c_i(1), c_i(2), \dots, c_i(\eta_{MOD} - 1)\},$$

$$c_i(0) = b_i(i \% \eta_{MOD}), c_i(1) = b_i((i + 1) \% \eta_{MOD}), \dots, c_i(\eta_{MOD} - 1) = b_i((i + \eta_{MOD} - 1) \% \eta_{MOD})$$

where i is the bit group index corresponding to the row index in block interleaving, i.e. output bit group $S_{demux_out}(i)$ to map each QAM symbol is cyclically shifted from $S_{demux_in}(i)$ according to bit group index i .

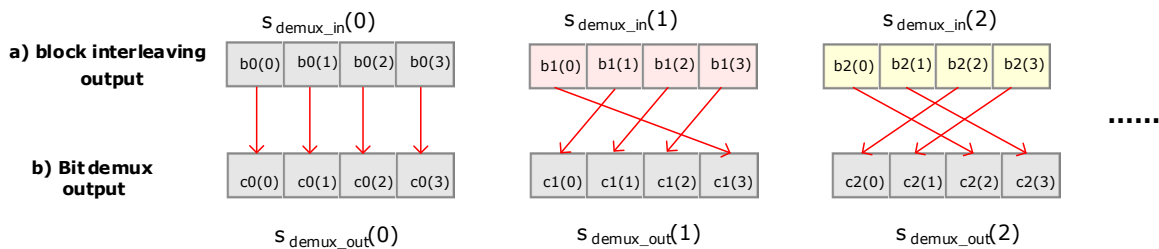

Figure 6.28 Example of bit demultiplexing rule for 16-NUC.

Figure 6.28 shows an example of the bit demultiplexing rule for 16-NUC.

This operation shall continue until all bit groups have been read from the Block Interleaver.

6.5.2.11 Constellation Mapping

Each demultiplexed LDPC block shall be mapped onto constellation symbols. According to the Mode $S_{demux_output}(i)$ shall be mapped to cells using constellations as described in Section 6.3.

6.5.3 L1-Detail Specific Block Details

The following subsections refer to blocks that only occur in the encoding of L1-Detail information.

6.5.3.1 Segmentation

The amount of L1-Detail signaling information bits is variable and depends mainly on the number of Subframes and the number of PLPs. Therefore, one or more FEC Frames may be required for transmission of the total amount of signaling. The number of FEC Frames for the L1-Detail signaling, $N_{L1D_FECFRAME}$, shall be determined as follows:

$$N_{L1D_FECFRAME} = \left\lceil \frac{K_{L1D_ex_pad}}{K_{seg}} \right\rceil$$

where $\lceil x \rceil$ means the smallest integer larger than or equal to x , K_{seg} for each L1-Detail Mode is defined in Table 6.25 and $K_{L1D_ex_pad}$ shall be determined by the value of the field **L1B_L1_Detail_size_bytes** in L1-Basic signaling, which denotes the length of the L1-Detail signaling (excluding L1 Padding bits), as described in Figure 6.29.

K_{seg} is a threshold number defined for segmentation based on the number of LDPC encoder input information bits (K_{ldpc}). K_{seg} causes the number of information bits in a coded block after the segmentation (K_{sig}) to be less than or equal to $(K_{ldpc} - M_{outer})$. Here, K_{ldpc} and M_{outer} are given in Table 6.18 and Table 6.19 in Sections 6.5.2.3 and 6.5.2.4, respectively. Note that the value of K_{seg} for L1-Detail Mode 1 is set to $(K_{ldpc} - M_{outer} - 720)$ to provide sufficient robustness.

Table 6.25 K_{seg} for L1-Detail Signaling

L1-Detail	K_{seg}
Mode 1	2352
Mode 2	3072
Mode 3	6312
Mode 4	
Mode 5	
Mode 6	
Mode 7	

The length of the L1_PADDING field for the L1-Detail signaling, K_{L1D_PAD} , shall be calculated as follows:

$$K_{L1D_PAD} = \left\lceil \frac{K_{L1D_ex_pad}}{N_{L1D_FECFRAME} \times 8} \right\rceil \times 8 \times N_{L1D_FECFRAME} - K_{L1D_ex_pad}$$

The L1_PADDING parts shall be filled with K_{L1D_PAD} zeros. This is illustrated in Figure 6.29. The final length of the whole L1-Detail signaling including the zero-padding bits, K_{L1D} shall be set as follows:

$$K_{L1D} = K_{L1D_ex_pad} + K_{L1D_PAD}.$$

The number of information bits in each of $N_{L1D_FECFRAME}$ blocks, K_{sig} shall then be given by:

$$K_{sig} = \frac{K_{L1D}}{N_{L1D_FECFRAME}}.$$

The L1-Detail signaling shall be segmented into $N_{L1D_FECFRAME}$ blocks when $N_{L1D_FECFRAME}$ is larger than 1, as illustrated in Figure 6.29

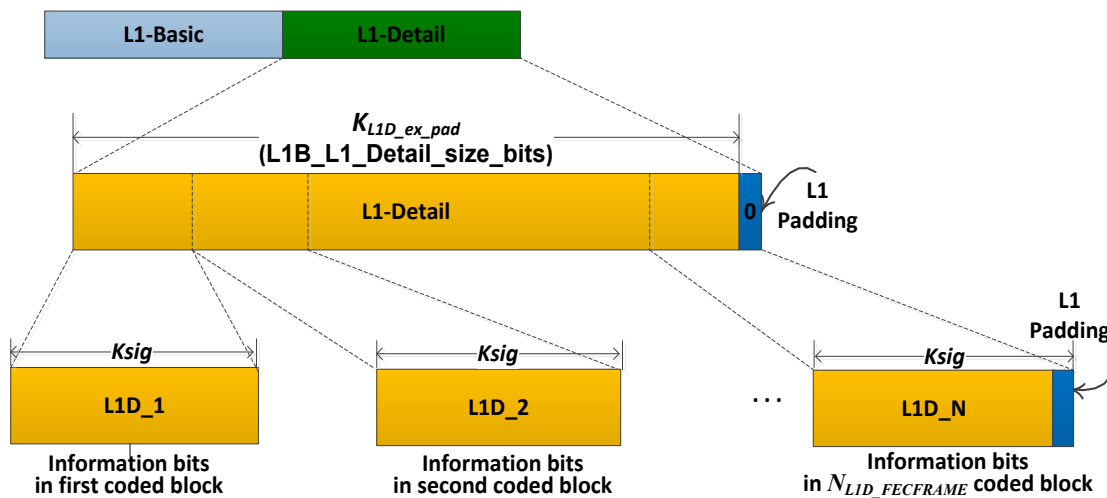

Figure 6.29 Segmentation of L1-Detail signaling.

Each segmented L1-Detail block shall be protected according to the procedures described in Section 6.5.2. All of the bits of each L1-Detail block with information size of K_{sig} shall be scrambled according to Section 6.5.2.2. Each scrambled L1-Detail signaling block shall then be protected by a concatenation of a BCH Outer Code and an LDPC Inner Code. Each L1-Detail signaling block shall be first BCH-encoded, where M_{outer} ($= 168$) BCH parity-check bits are appended to K_{sig} information bits of each block. The resulting concatenation of the information bits of each block and the BCH parity bits shall then be protected by a shortened and punctured 16K LDPC code, as described in Sections 6.5.2.8 and 6.5.2.9. When required, repetition shall be applied before puncturing, as described in Section 6.5.2.7.

6.5.3.2 Additional Parity

To increase further the robustness of the L1-Detail signaling, additional parity bits for the L1-Detail signaling of the Frame $\#(i)$ may be transmitted in the closest (in time) previous Frame $\#(i-1)$ that has the same bootstrap major/minor version as does the Frame $\#(i)$. Figure 6.30 shows how additional parity bits for L1-Detail in Frame $\#(i)$ shall be transmitted in the Preamble of Frame $\#(i-1)$.

The use of additional parity bits for L1-Detail of Frame # (i) with the same major/minor bootstrap version is signaled with **L1B_L1_Detail_additional_parity_mode** in the Frame # $(i-1)$. When **L1B_L1_Detail_additional_parity_mode** is set to '00' in Frame # $(i-1)$, additional parity for L1-Detail signaling of the Frame # (i) shall not be transmitted in Frame # $(i-1)$.

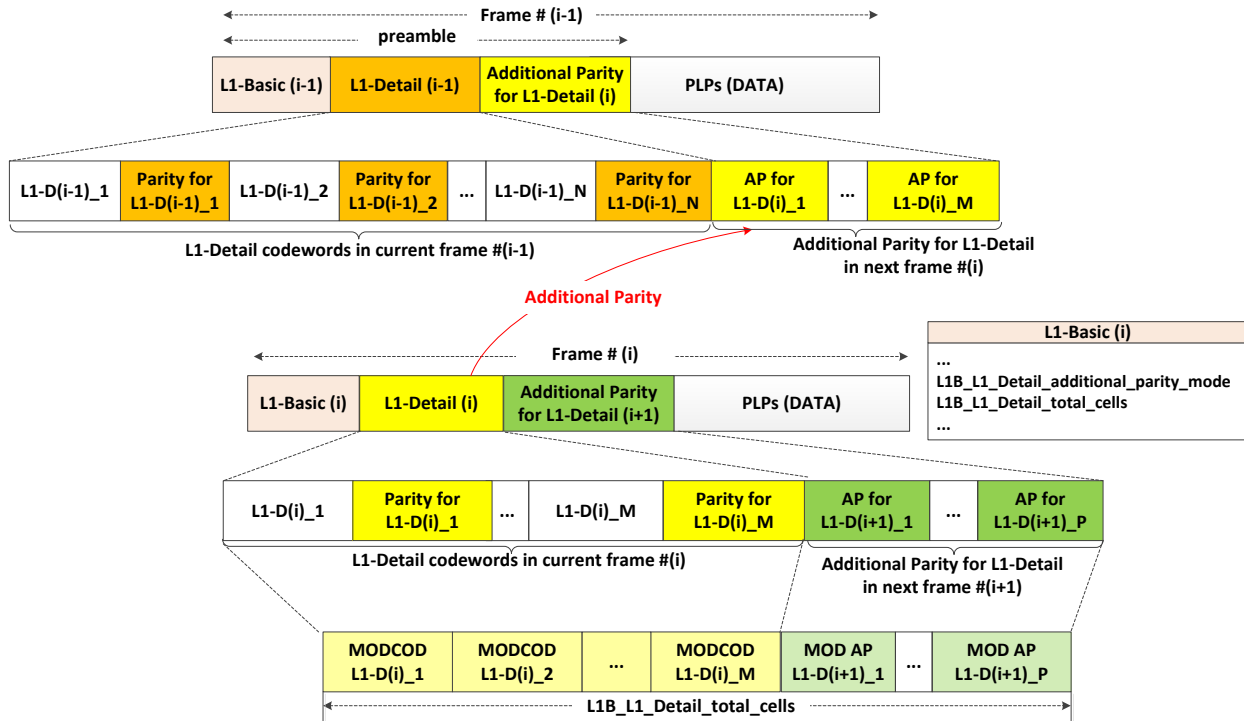

Figure 6.30 Additional parity for L1-Detail signaling.

The result of using additional parity is diversity gain for the L1 signaling. When the number of punctured bits is larger than the number of additional parity bits, additional parity bits shall be generated by selecting the bits among punctured bits based on puncturing order. Otherwise, additional parity bits shall be generated by selecting all punctured bits and then selecting $(N_{AP} - N_{punc})$ parity bits.

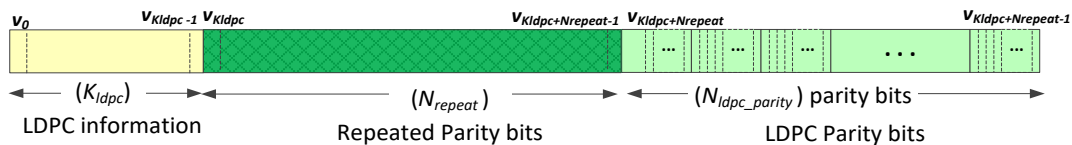

Figure 6.31 Repeated LDPC codeword.

The number of additional parity bits shall be decided from the total number of transmitted bits in the current Frame. Based on the repeated LDPC codeword denoted by $V = (v_0, v_1, \dots, v_{Ninner+Nrepeat-1})$ as shown in Figure 6.31, additional parity bits shall be generated by the following operations:

Step 1) Compute the temporary number of additional parity bits such that

$$N_{AP_temp} = \min \left\{ \begin{array}{l} 0.5 \times K \times (N_{outer} + N_{ldpc_parity} - N_{punc} + N_{repeat}), \\ (N_{ldpc_parity} + N_{punc} + N_{repeat}) \end{array} \right\}, K=0,1,2$$

where K corresponds to the field **L1B_L1_Detail_additional_parity_mode** in L1-Basic and where the operation

$$\min(a,b) = \begin{cases} a, & \text{if } a \leq b \\ b, & \text{if } b < a \end{cases}$$

L1B_L1_Detail_additional_parity_mode is the ratio of the number of additional parity bits to half of the total number of bits in the transmitted coded L1-Detail signaling block, which is the L1-Detail signaling block following repetition, puncturing and zero-removal. Note that the value of **L1B_L1_Detail_additional_parity_mode** related to the L1-Detail of Frame (#i) is carried in Frame (#i-1); that is, the previous Frame.

Step 2) Derive the number of additional parity bits as the following integer multiple of the modulation order:

$$N_{AP} = \left\lfloor \frac{N_{AP_temp}}{\eta_{MOD}} \right\rfloor \times \eta_{MOD}$$

where the operation $\lfloor x \rfloor$ means the largest integer less than or equal to x and η_{MOD} denotes the modulation order taking the value 2, 4, 6, and 8 for QPSK, 16-NUC, 64-NUC and 256-NUC, respectively.

Step 3) If $N_{AP} \leq N_{punc}$, then punctured parity bits

$$\left(v_{N_{repeat}+N_{inner}-N_{punc}}, v_{N_{repeat}+N_{inner}-N_{punc}+1}, \dots, v_{N_{repeat}+N_{inner}-N_{punc}+N_{AP}-1} \right)$$

shall be selected for additional parity as shown in Figure 6.32.

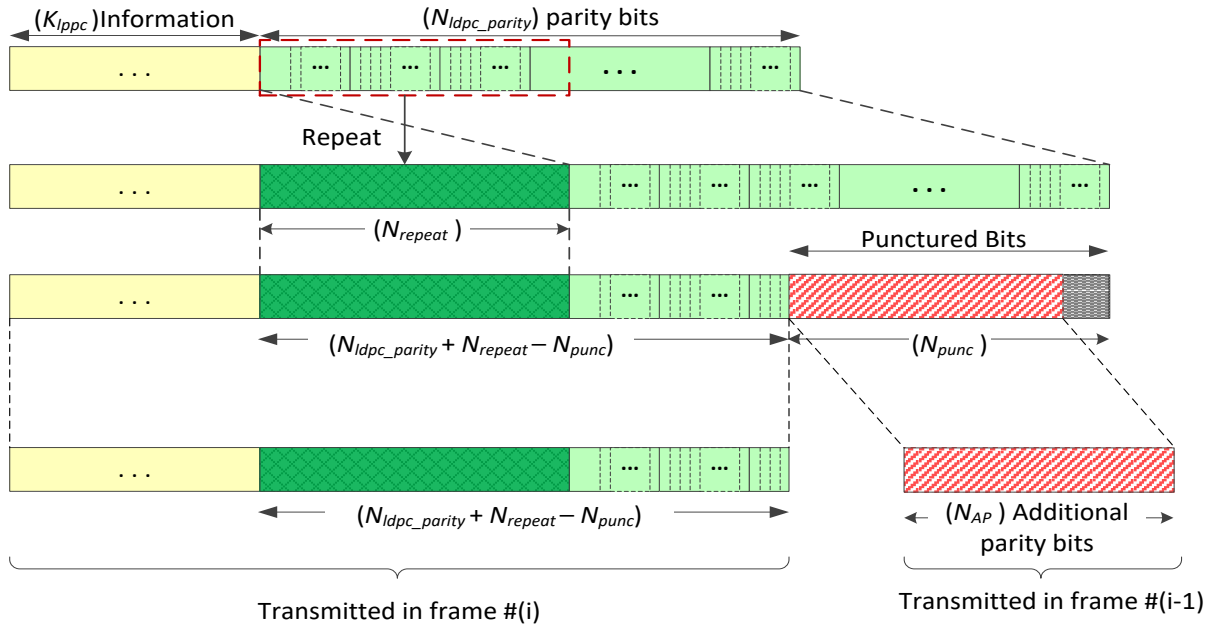

Figure 6.32 Additional parity generation for L1-Detail signaling ($N_{AP} \leq N_{punc}$).

Otherwise ($N_{AP} > N_{punc}$); therefore all punctured parity bits ($v_{N_{repeat}+N_{inner}-N_{punc}}, v_{N_{repeat}+N_{inner}-N_{punc}+1}, \dots, v_{N_{repeat}+N_{inner}-1}$) shall be selected, and additionally, parity bits ($v_{K_{ldpc}}, v_{K_{ldpc}+1}, \dots, v_{K_{ldpc}+N_{AP}-N_{punc}-1}$) shall be selected and appended to the punctured bits as shown in Figure 6.33.

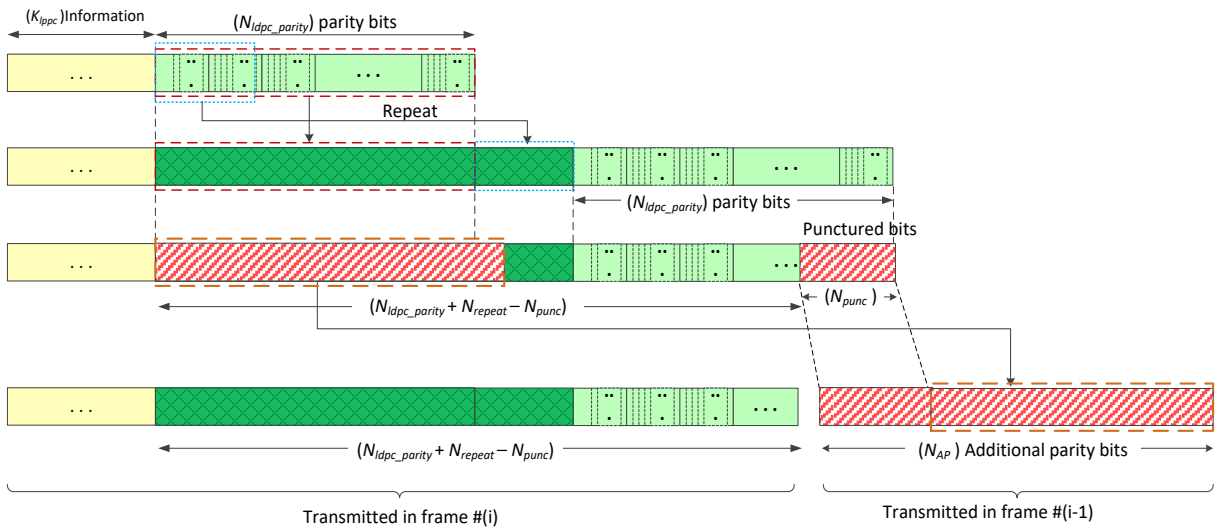

Figure 6.33 Additional parity generation for L1-Detail signaling ($N_{AP} > N_{punc}$).

Note that the number of bits for repetition, N_{repeat} , is 0 for L1-Detail Modes 2, 3, 4, 5, 6 and 7.

The additional parity bits shall be bit-interleaved and mapped onto constellations as described in Sections 6.5.2.10 and 6.5.2.11, respectively. The constellations generated for the additional parity bits shall be generated in the same manner as for the repeated, punctured and zero-removed L1-Detail signaling bits that are transmitted in the current Frame. After mapping onto constellations, the additional parity bits shall be appended to coded L1-Detail signaling blocks in the Frame preceding the current Frame carrying the L1-Detail signaling of current Frame, as illustrated in Figure 6.30.

7. FRAMING AND INTERLEAVING

The framing and interleaving block consists of three parts: time interleaving, framing and frequency interleaving. The input to the time interleaving and framing blocks consists of one or more PLPs, however the output of the framing block is OFDM symbols, either Preamble, Data, or Subframe Boundary Symbols which are arranged in the order in which they appear in the final Frame. The frequency interleaver operates on OFDM symbols. A block diagram of the framing and interleaving is shown in Figure 7.1.

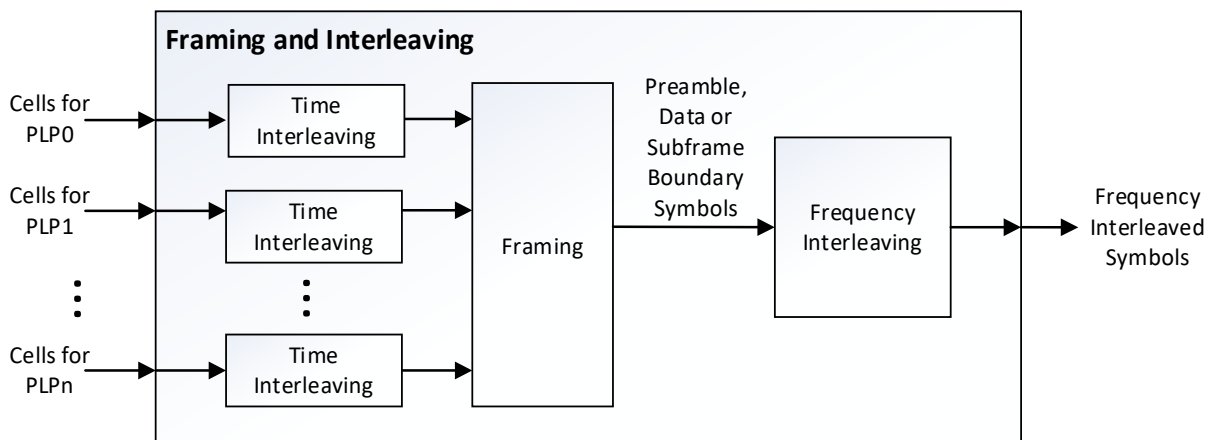

Figure 7.1 Block diagram of framing and interleaving.

7.1 Time Interleaving

The input to the time interleaving block is a stream of cells output from the mapper block, and the output of the time interleaving block is a stream of time-interleaved cells.

7.1.1 Time Interleaver Modes

Each PLP is configured with one of the following time interleaver modes as applicable: no time interleaving, Convolutional Time Interleaver (CTI) mode (see Section 7.1.4), or Hybrid Time Interleaver (HTI) mode (see Section 7.1.5). The time interleaver mode for a PLP is indicated by the L1-Detail signalling field **L1D_plp_TI_mode**. The time interleaver mode indicated for an Enhanced PLP shall be the same as the time interleaver mode indicated for the Core PLP(s) with which the Enhanced PLP is layered division multiplexed.

When, as determined at the input to the time interleaver, a complete delivered product is composed of only a single constant-cell-rate PLP or is composed of a single constant-cell-rate Core PLP and one or more constant-cell-rate Enhanced PLPs layered division multiplexed with that Core PLP, the PLP(s) comprising that complete delivered product shall be configured with one of the following time interleaver modes: no time interleaving, CTI mode, or HTI mode.

When, as determined at the input to the time interleaver, a complete delivered product is composed of PLPs having characteristics different from those described in the preceding paragraph, the PLPs comprising that complete delivered product shall be configured with one of the following time interleaver modes: no time interleaving or HTI mode.

The time interleaver mode(s) for the PLPs of a particular complete delivered product shall be configured independently of the time interleaver mode(s) for the PLP(s) of any other delivered products transmitted within the same RF channel. When a particular delivered product contains multiple Core PLPs and/or PLPs that are not layered division multiplexed, those PLPs may be configured with the same or different time interleaver modes (i.e., no time interleaving and/or HTI mode) and/or the same or different time interleaver parameters.

When a particular complete delivered product contains multiple Core PLPs that are not layered-division multiplexed and all of those Core PLPs use the HTI mode, either all of those Core PLPs shall use intra-Subframe interleaving or else all of those Core PLPs shall use inter-Subframe interleaving (i.e., all of those Core PLPs shall be configured with the same value of **L1D_plp HTI_inter_subframe**). When inter-Subframe interleaving is used for those Core PLPs (i.e., **L1D_plp HTI_inter_subframe** = 1), then all of those Core PLPs shall use the same time interleaving unit (N_{IU}).

When a particular complete delivered product contains multiple Core PLPs that are not layered-division multiplexed and at least one of those Core PLPs uses the no-TI mode, any of those Core PLPs configured with the HTI mode shall use the intra-Subframe interleaving mode (i.e., **L1D_plp HTI_inter_subframe** = 0).

When time interleaving is not configured for a PLP, that PLP's cells shall be output in the same order as that in which they would have arrived at the input of the time interleaving function and without delay.

7.1.2 Time Interleaver Size

The maximum size of the TI memory for a single, complete delivered product shall be $M_{TI} = 2^{19}$ cells, except for extended interleaving mode, for which the maximum size of the TI memory for a single, complete delivered product shall be $M_{TI} = 2^{20}$ cells. The TI memory size shall include all necessary parts; that is, the Convolutional Time Interleaver in CTI mode and the Cell, Twisted Block and Convolutional Delay Line interleavers in HTI mode.

In the CTI mode the entire TI memory may be used by the PLP associated with the particular CTI, depending on the configured depth of the Convolutional Time Interleaver.

In the HTI mode, the total memory shall be shared between PLPs carrying components of the same complete delivered product. The memory allocated for each PLP shall be determined from the throughput for that PLP.

Note that receiver manufacturers can choose always to implement the time deinterleaver memory with $M_{TI} = 2^{19}$ cells, irrespective of the extended time interleaving mode, by quantizing the received data entering the time deinterleaver with a different resolution depending on the robustness of the constellation, that is, lower resolution for QPSK and extended time interleaving, and higher resolution for all other combinations.

7.1.3 Extended Interleaving

Extended interleaving mode may be optionally enabled in order to increase the time interleaving depth. Extended interleaving mode is signaled by **L1D_plp_TI_extended_interleaving**. Extended interleaving shall only be used when the modulation is QPSK. Extended interleaving shall not be used for LDM. In the CTI mode when extended interleaving is used, **L1D_plp_CTI_depth=010** signals

$N_{rows} = 1254$, and $L1D_plp_CTI_depth=011$ signals $N_{rows} = 1448$, corresponding to time interleaving depths of approximately 300 ms, and 400 ms, respectively.

When extended interleaving is used in the HTI mode, the number of FEC Blocks per TI Block may be increased. The maximum allowable number of FEC Blocks per TI Block in the extended HTI mode is approximately twice the maximum allowable in the non-extended HTI mode.

7.1.4 Convolutional Time Interleaver (CTI) Mode

The time interleaving block for the CTI Mode is shown in Figure 7.2. It consists of a Convolutional Time Interleaver. The input and output of the time interleaving block is a sequence of cells.

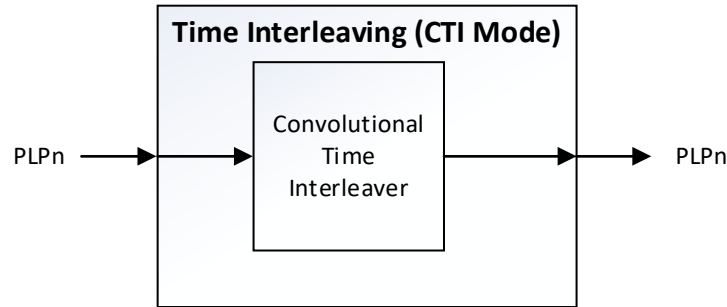

Figure 7.2 Block diagram for time interleaving for CTI Mode.

7.1.4.1 Convolutional Time Interleaver

The Convolutional Time Interleaver is depicted in Figure 7.3.

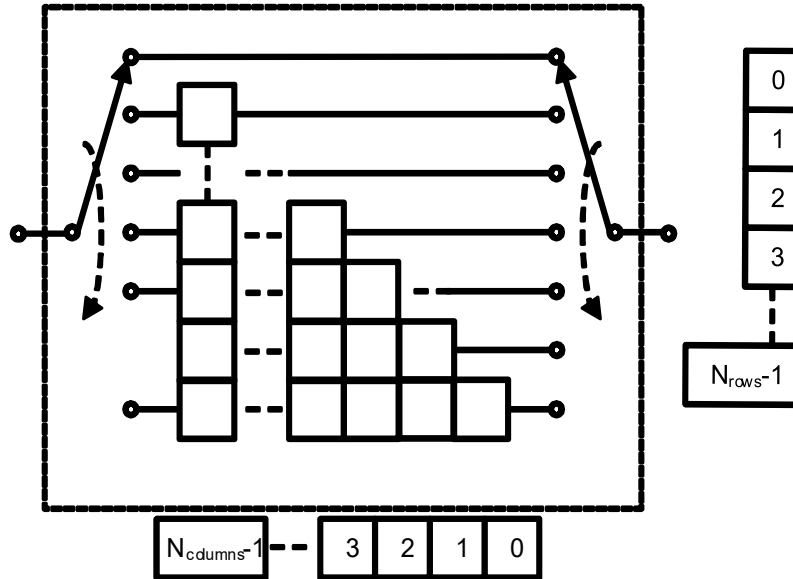

Figure 7.3 Block diagram of the Convolutional Time Interleaver.

The input to the Convolutional Time Interleaver block shall be a sequence of cells g_q (where $q = 0, 1, \dots$) from the mapper output. The CTI shall consist of N_{rows} delay lines, with the k -th line having k delay elements, $k = 0, 1, \dots, N_{rows}-1$. Each delay element shall be capable of storing one cell. The number of columns $N_{columns}$ shall be $N_{rows} - 1$. Input and output shall be controlled by two commutators, cyclically switching downwards after one cell is written in or read out, respectively.

For each cell g_q , the commutators shall be located at the same row k . The resulting total number of delay elements is $N_{rows} \times N_{columns} / 2$.

When the input commutator is located at row k , a cell g_q shall be written to this delay line. First, each delay element from this line shall shift its memory content to the neighbouring right delay element, and the content from the right-most delay element shall be output via the output commutator. Next, the input cell g_q shall be written to the left-most delay element of this line. Both commutators shall then move cyclically to the next line $(k+1) \bmod N_{rows}$.

The structures for CTI Mode are defined in terms of the parameter N_{rows} , see Table 9.26 for details. The values $N_{rows} \in \{1024, 887, 724, 512\}$ represent time interleaving depths of approximately 200 ms, 150 ms, 100 ms and 50 ms, respectively, assuming the Core PLP occupies the full channel bandwidth. The depth of the Convolutional Time Interleaver, shall be indicated by the parameter **L1D_plp_CTI_depth**.

In contrast to HTI Mode, the CTI Mode TI outputs cells continuously and insertion of dummy modulation values to achieve an integer number of FEC Blocks per Subframe is not required, thus reducing the overhead. The position of the commutator at the start of each Subframe shall be signaled by **L1D_plp_CTI_start_row** and the position of the start of the first complete FEC Block shall be signaled by **L1D_plp_CTI_fec_block_start**.

7.1.4.2 Initial State of the Delay Elements

For CTI according to Section 7.1.4.1 both with and without extended interleaving according to Section 7.1.3, the initial contents of the delay elements shall be defined as follows:

Since the number of delay elements in the CTI is $N_{rows} \times N_{columns} / 2$, a total number of $\eta_{MOD} \times N_{rows} \times N_{columns} / 2$ bits shall be generated using the same PRBS generator described in Section 5.2.3, starting from the initial state. η_{MOD} is the modulation order as defined in Table 6.14, and shall be used according to the chosen modulation of the Core PLP. These bits shall be mapped to QAM cells according to Section 6.3, forming a sequence of cells g_q .

The delay elements shall be then filled by g_q from left to right and from top to bottom. This means g_0 shall be the initial state of the delay element in row $k = 1$, and g_1 shall be the initial state of the left-most delay element in row $k = 2$, while g_2 shall be the initial state of the second delay element in this row. In row $k = 3$, the three delay elements from left to right have initial states g_3, g_4, g_5 and so on until the last of these cells forms the initial state of the right-most delay element of the last row, $k = N_{rows} - 1$.

7.1.5 Hybrid Time Interleaver (HTI) Mode

The time interleaving for the HTI mode is shown in Figure 7.4, and it consists of a Cell Interleaver, a Twisted Block Interleaver (TBI), and a Convolutional Delay Line (CDL). The input to the Hybrid Time Interleaver is a sequence of cells from the mapper block, and the output is a sequence of time-interleaved cells.

The Cell Interleaver takes input cells in FEC Blocks and arranges them into TI Blocks. A TI Block consists of one or more FEC Blocks. The Cell Interleaver interleaves cells within each FEC Block. The use of the Cell Interleaver is optional and is indicated by the parameter **L1D_plp_HTI_cell_interleaver**.

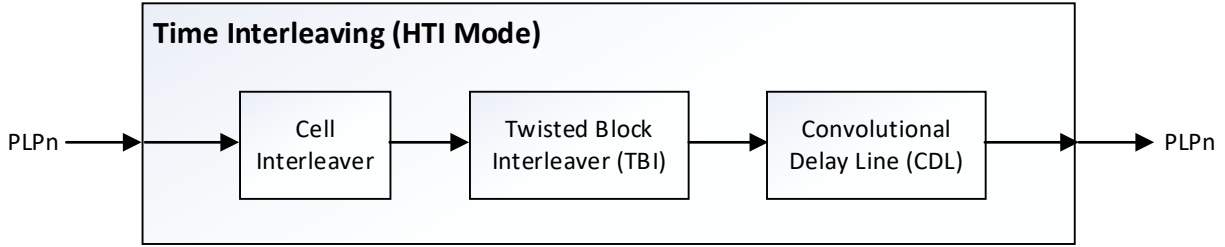

Figure 7.4 Block diagram for time interleaving for HTI mode.

The Twisted Block Interleaver (TBI) performs intra-Subframe interleaving by interleaving TI Blocks. A TI Block is composed of one or more cell-interleaved FEC Blocks ($L1D_plp_HTI_cell_interleaver=1$) or non-cell-interleaved FEC Blocks directly from the mapper block ($L1D_plp_HTI_cell_interleaver=0$).

After block interleaving, the Convolutional Delay Line optionally performs inter-Subframe interleaving. When configured, it spreads a block-interleaved TI Block over multiple Subframes. The use of the Convolutional Delay Line is signaled with the parameter $L1D_plp_HTI_inter_subframe$.

7.1.5.1 Relationship between IF and TI Blocks

FEC Blocks from the mapper block shall be grouped into interleaving frames (IFs). Note that interleaving frames and physical layer Frames (as specified in Section 7.2) are independent constructs. Each IF shall contain a dynamically variable integer number of FEC Blocks. The number of FEC Blocks in the IF of index n is denoted by $N_{BLOCKS_IF}(n)$. $N_{BLOCKS_IF}(n)$ may vary from a minimum value of 1 to a maximum value $N_{BLOCKS_IF_MAX}$. Each IF is either mapped directly onto one Subframe or spread out over multiple Subframes. Each IF is also divided into one or more TI Blocks, where a TI Block is the basic unit to operate the Cell Interleaver, Twisted Block Interleaver and Convolutional Delay Line. The number of TI Blocks in an interleaving frame, denoted by N_{TI} , shall be an integer and is signaled by $L1D_plp_HTI_num_ti_blocks$ in conjunction with $L1D_plp_HTI_inter_subframe$ (i.e. $L1D_plp_HTI_inter_subframe = 0$). The TI Blocks within an IF may contain slightly different numbers of FEC Blocks. When an IF extends over multiple Subframes (i.e. $L1D_plp_HTI_inter_subframe = 1$), then one IF contains exactly one TI Block and $N_{TI} = 1$. The number of FEC Blocks in a TI Block of index s of an interleaving frame n is denoted by $N_{FEC_TI}(n, s)$, where $0 \leq s < N_{TI}$.

When $N_{TI} = 1$, then there will be only one TI Block, with index $s = 0$, per IF and $N_{FEC_TI}(n, s)$ shall be equal to the number of FEC Blocks in the IF, $N_{BLOCKS_IF}(n)$.

When $N_{TI} > 1$, then the value of $N_{FEC_TI}(n, s)$ for each TI Block (index s) within the IF (index n) shall be calculated as follows:

$$N_{FEC_TI}(n, s) = \begin{cases} \left\lfloor \frac{N_{BLOCKS_IF}(n)}{N_{TI}} \right\rfloor & , s < N_{TI} - [N_{BLOCKS_IF}(n) \bmod N_{TI}] \\ \left\lfloor \frac{N_{BLOCKS_IF}(n)}{N_{TI}} \right\rfloor + 1 & , s \geq N_{TI} - [N_{BLOCKS_IF}(n) \bmod N_{TI}] \end{cases}$$

This ensures that the values of $N_{FEC_TI}(n, s)$ for the TI Blocks within an IF differ by at most one FEC Block and that the smaller TI Blocks come first. The FEC Blocks at the input shall be assigned to TI Blocks in increasing order of s . $N_{FEC_TI}(n, s)$ may vary in time from a minimum value of 1

to a maximum value $N_{FEC_TI_MAX} \cdot N_{FEC_TI_MAX}$ can be determined from $N_{BLOCKS_IF_MAX}$ by the following formula:

$$N_{FEC_TI_MAX} = \left\lceil \frac{N_{BLOCKS_IF_MAX}}{N_{TI}} \right\rceil.$$

Note that $N_{BLOCKS_IF}(n)$ is signaled as **L1D_plp_HTI_num_fec_blocks** and $N_{BLOCKS_IF_MAX}$ is signaled as **L1D_plp_HTI_num_fec_blocks_max**.

7.1.5.2 Cell Interleaver

The input to the Cell Interleaver is a sequence of cells $G(r) = (g_{r,0}, g_{r,1}, g_{r,2}, \dots, g_{r,N_{cells}-1})$, arranged in FEC Blocks, where r represents the incremental index of a FEC Block within a TI Block and shall be reset to zero at the beginning of each TI Block. N_{cells} indicates the FEC Block length and is determined by N_{ldpc}/η_{MOD} (see Table 6.14).

Figure 7.5 shows the cell interleaving operation; cell interleaving shall be accomplished by writing a FEC Block into memory and reading the FEC Block pseudo-randomly according to the method described below. The permutation sequence varies every FEC Block within a TI Block. Each permutation sequence shall be determined by shifting one pseudo random sequence differently.

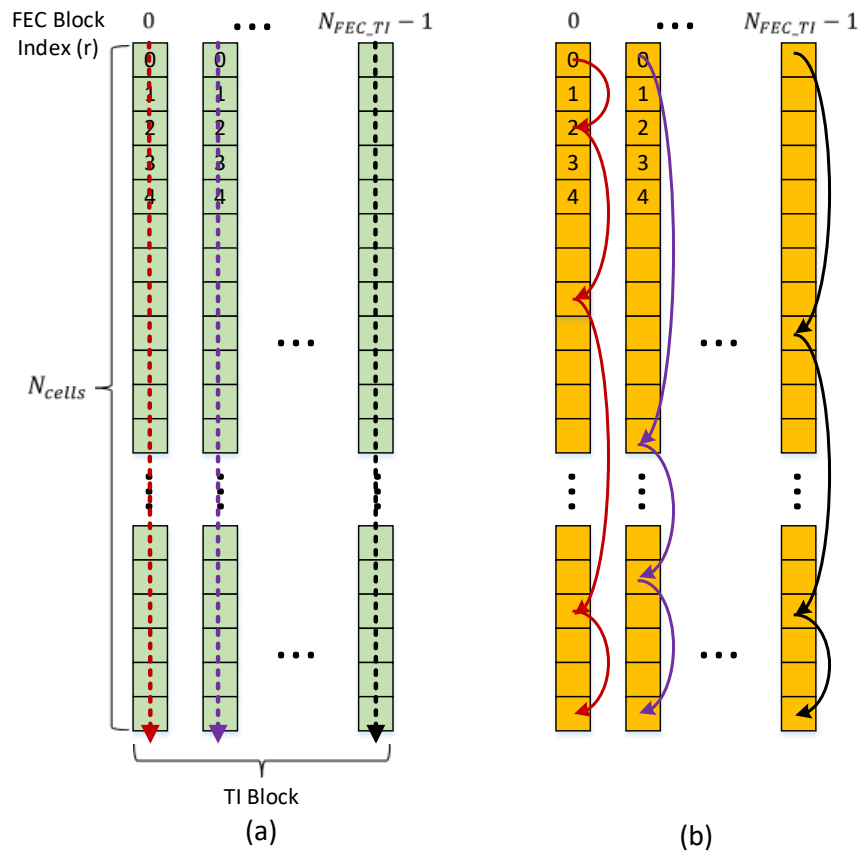

Figure 7.5 Block diagram of the Cell Interleaver: (a) Linear writing operation, (b) Pseudo-random reading operation.

From Figure 7.5 the output of the Cell Interleaver shall be a vector $D(r) = (d_{r,0}, d_{r,1}, d_{r,2}, \dots, d_{r,N_{cells}-1})$ with $d_{r,q}$, defined by

$$d_{r,q} = g_{r,L_r(q)} \text{ for each } q = 0, 1, \dots, N_{cells} - 1,$$

$L_r(q)$ is a permutation function applied to the r -th FEC Block of the TI Block and is given by

$$L_r(q) = [L_0(q) + P(r)] \bmod N_{cells}$$

where $L_0(q)$ is the basic permutation function (typically for the first FEC Block of a TI Block) and $P(r)$ is the shift value to be used in the r -th FEC Block of the TI Block.

A constant shift (modulo N_{cells}) shall be added to the basic permutation in order to generate a different interleaving sequence over each FEC Block.

The basic permutation function $L_0(q)$ is defined by the following algorithm.

An N_d -bit binary word S_i is defined as follows:

$$\text{For all } i: \quad S_i[N_d - 1] = (i \bmod 2),$$

$$\text{For } i = 0, 1: \quad S_i[N_d - 2, N_d - 3, \dots, 1, 0] = [0, 0, \dots, 0, 0],$$

$$\text{For } i = 2: \quad S_2[N_d - 2, N_d - 3, \dots, 1, 0] = [0, 0, \dots, 0, 1],$$

$$\text{For } 2 < i < 2^{N_d}: \quad S_i[N_d - 3, N_d - 4, \dots, 1, 0] = S_{i-1}[N_d - 2, N_d - 3, \dots, 2, 1],$$

$$\text{for } N_d = 11: S_i[9] = S_{i-1}[0] \oplus S_{i-1}[3],$$

$$\text{for } N_d = 12: S_i[10] = S_{i-1}[0] \oplus S_{i-1}[2],$$

$$\text{for } N_d = 13: S_i[11] = S_{i-1}[0] \oplus S_{i-1}[1] \oplus S_{i-1}[4] \oplus S_{i-1}[6],$$

$$\text{for } N_d = 14: S_i[12] = S_{i-1}[0] \oplus S_{i-1}[1] \oplus S_{i-1}[4] \oplus S_{i-1}[5] \oplus S_{i-1}[9] \oplus S_{i-1}[11],$$

$$\text{for } N_d = 15: S_i[13] = S_{i-1}[0] \oplus S_{i-1}[1] \oplus S_{i-1}[2] \oplus S_{i-1}[12],$$

where $N_d = \lceil \log_2 N_{cells} \rceil$. The sequence $L_0(q)$ is then generated by discarding values of S_i greater than or equal to N_{cells} as defined in the following algorithm:

$$q = 0;$$

$$\text{for } (i = 0; i < 2^{N_d}; i = i + 1)$$

$$\{$$

$$L_0(q) = \sum_{j=0}^{N_d-1} S_i(j) 2^j;$$

$$\text{if } (L_0(q) < N_{cells}), q = q + 1;$$

$$\}$$

The shift value $P(r)$ to be applied in the r -th FEC Block is the conversion to decimal of the bit-reversed value of a counter k in binary notation over N_d bits. The counter is incremented if the bit-reversed value is too large.

```

k = 0;
for (r = 0; r < NFEC_TI(n, s); r++)
{
    P(r) = Ncells;
    while (P(r) ≥ Ncells)
    {
        
$$P(r) = \sum_{j=0}^{N_d-1} \left\lfloor \frac{k - \lfloor \frac{k}{2^{j+1}} \rfloor 2^{j+1}}{2^j} \right\rfloor 2^{N_d-1-j};$$

        k = k + 1;
    }
}

```

where $N_{FEC_TI}(n, s)$ is the number of FEC Blocks in TI Block index s of interleaving frame n . For example, under the condition of $N_{cells} = 10800$ and $N_d = 14$, the shift value $P(r)$ to be added to the basic permutation (for $r = 0, 1, 2, 3$, etc.) would be 0, 8192, 4096, 2048, 10240, 6144, 1024, 9216, etc.

7.1.5.3 Joint Operation of Twisted Block Interleaver and Convolutional Delay Line in HTI Mode

As a joint operation of the Twisted Block Interleaver (TBI) and Convolutional Delay Line (CDL) Figure 7.6 depicts an operational example.

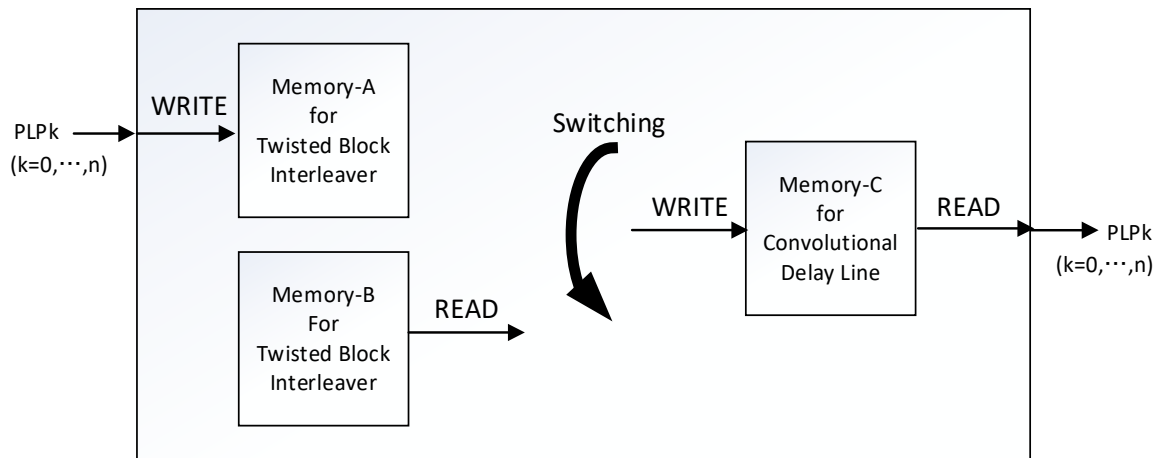

Figure 7.6 Example of joint operation of TBI and CDL in the HTI.

For each PLP, the first TI Block is written to the first memory for the Twisted Block Interleaver. The second TI Block is written to the second memory for the Twisted Block Interleaver while the first memory is being read. Simultaneously, the read-out TI Block (intra-Subframe interleaved TI Block) from the first memory is delivered to the memory for the convolutional interleaver through a first-in-first-out shift register (FIFO) process and so on. For intra-Subframe interleaving only the Twisted Block Interleaver is used, while for inter-Subframe interleaving both the Twisted Block Interleaver and convolutional interleaver are operated jointly.

7.1.5.4 Twisted Block Interleaver

In the interleaving of each TI Block, the TBI shall store in its memory (one per PLP) the cells $d_{n,s,0,0}, d_{n,s,0,1}, \dots, d_{n,s,0,N_{cells}-1}, d_{n,s,1,0}, d_{n,s,1,1}, \dots, d_{n,s,N_{FEC_TI}(n,s)-1,0}, d_{n,s,N_{FEC_TI}(n,s)-1,1}, \dots, d_{n,s,N_{FEC_TI}(n,s)-1,N_{cells}-1}$ of the $N_{FEC_TI}(n,s)$ FEC Blocks from the output of the Cell Interleaver, where $d_{n,s,r,q}$ is the output cell from the Cell Interleaver, belonging to TI Block s in interleaving frame n .

In the Twisted Block Interleaver, the number of rows N_r shall be equal to the number of cells in a FEC Block while the number of columns N_c shall be set to $N_{FEC_TI_MAX}$. A graphical representation of the Twisted Block Interleaver is shown in Figure 7.7. Additionally, in the interleaving operation, the concept of a virtual FEC Block is defined and the number of virtual FEC Blocks in a TI Block is denoted by $N_{FEC_TI_Diff}(n,s) = N_{FEC_TI_MAX} - N_{FEC_TI}(n,s)$. Note that any virtual FEC Blocks that are included in a TI Block shall be ahead of data FEC Blocks in the same TI Block for the interleaving in a given memory. A non-zero value of $N_{FEC_TI_Diff}(n,s) \neq 0$ indicates that the number of FEC Blocks (or columns) varies between TI Blocks depending on the cell rate.

The FEC Blocks shall be serially written column-wise into the Twisted Block Interleaver memory part as shown in Figure 7.7(a), where it is generally assumed that $N_{FEC_TI_Diff}(n,s) \neq 0$. Then, cells shall be read out diagonal-wise from the first row (rightwards along the row beginning with the left-most column) to the last row out as shown in Figure 7.7(b). During the reading process, virtual cells belonging to virtual FEC Blocks shall be skipped.

In a block interleaving array, the diagonal-wise reading can be performed by calculating the position for data and virtual cells with a coordinate (R_i, C_i) (for $i = 0, \dots, N_r N_c - 1$):

$$R_i = i \bmod N_r,$$

$$T_i = R_i \bmod N_c,$$

$$C_i = \left(T_i + \left\lfloor \frac{i}{N_r} \right\rfloor \right) \bmod N_c,$$

where R_i and C_i indicate the row and column indexes, respectively, and T_i is a twisting parameter. Assuming cells are read out sequentially from a linear memory array, the cell position can be calculated as $\theta_i = N_r C_i + R_i$. Note that virtual cells shall be skipped during the reading process if the condition of $\theta_i \geq N_{FEC_TI_Diff}(n,s) \cdot N_r$ is not satisfied.

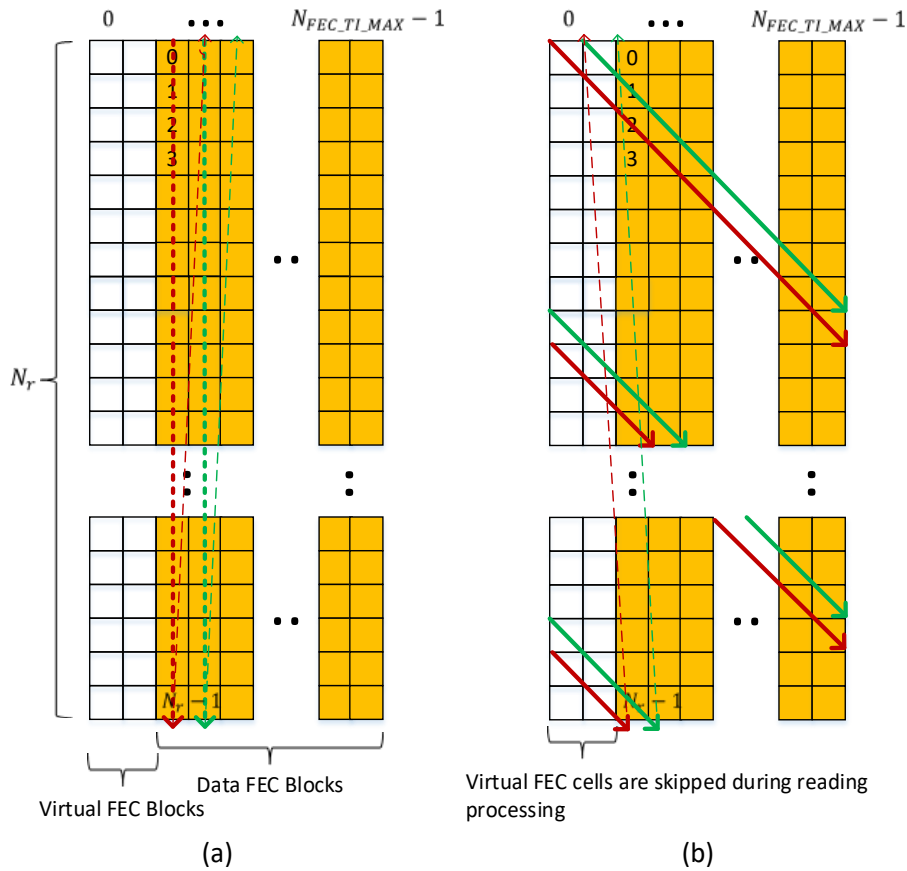

Figure 7.7 Block diagram of Twisted Block Interleaver: (a) linear writing operation, (b) diagonal-wise reading operation.

7.1.5.5 Convolutional Delay Line

The Convolutional Delay Line spreads FEC Blocks over multiple Subframes in order to realize inter-Subframe interleaving. The block diagram of the CDL is shown in Figure 7.8. The delay-line consists of N_{IU} branches, which split a TI Block into N_{IU} interleaving units and spread these interleaving units over N_{IU} Subframes. To this end, each branch is connected to a sequence of FIFO registers acting as delay elements. The number of cells which a FIFO register can store maximally is denoted as $M_{i,j}$. The top branch does not contain any FIFO register; each lower branch adds an additional FIFO register.

The FIFO register sizes shall be obtained as follows:

- $L_{IU} = \text{floor}(N_r/N_{IU})$, where $\text{floor}(x)$ is the largest integer $\leq x$.
- Each FIFO register present in the first $N_{\text{large}} = N_r \bmod N_{IU}$ branches (this includes the first branch of the CDL which does not contain any FIFO registers) shall contain $M_{i,j} = (L_{IU} + 1) \cdot N_{FEC_TI_MAX}$ cells. Here mod represents the modulo-operation.
- Each FIFO register present in the following $N_{\text{small}} = N_{IU} - N_{\text{large}}$ branches shall contain $M_{i,j} = L_{IU} \cdot N_{FEC_TI_MAX}$ cells.

All FIFO registers contain exactly $L_{IU} \cdot N_{FEC_TI_MAX}$ cells for the case when N_r is an integer multiple of N_{IU} such that $N_{large} = 0$. The number of columns in the Twisted Block Interleaver, $N_{FEC_TI}(n, s)$, may change between TI Blocks.

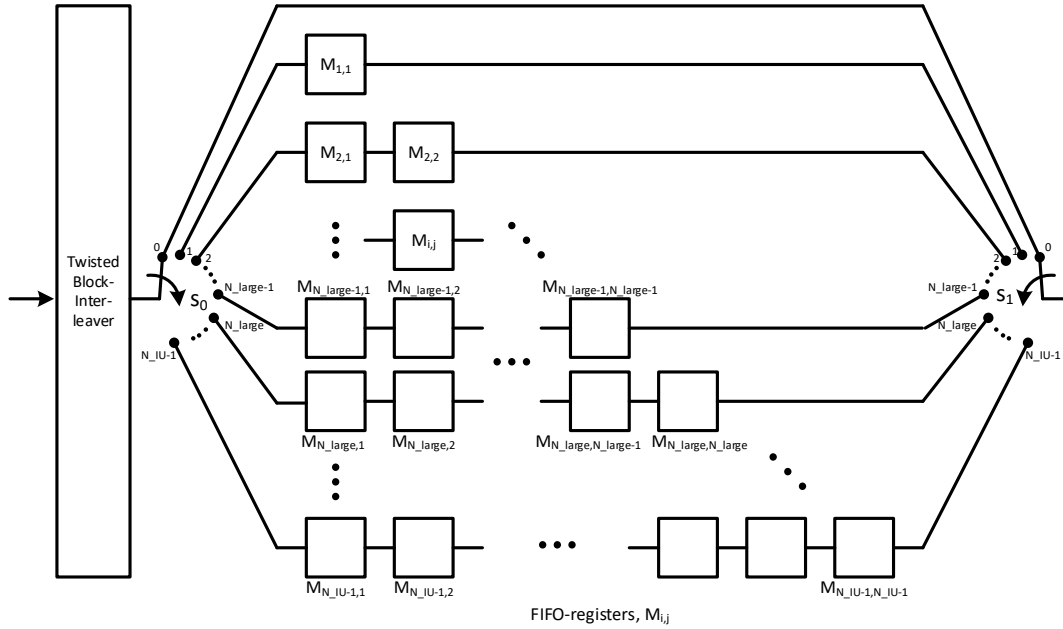

Figure 7.8 Block diagram of Convolutional Delay Line used in the HTI.

Switch s_0 connects the TBI to the CDL. Switch s_1 connects the CDL to the framing block. The movement of the switches shall be synchronized; i.e., they shall always point to identical branches of the CDL. From the last branch of the CDL the switches shall then move back to the first branch of the CDL. Both switches (s_0 and s_1) shall move from branch n of the CDL to the immediately subjacent branch $n+1$ of the CDL when $N_{FEC_TI_MAX}$ cells, consisting of $N_{FEC_TI}(n, s)$ data cells and $(N_{FEC_TI_MAX} - N_{FEC_TI}(n, s))$ virtual cells, are written to the CDL. Both switches (s_0 and s_1) shall be reset to the first branch of the CDL (i.e., branch 0) at the start of every Subframe. Virtual cells shall not be read from the TBI and shall not be passed on to the CDL. However, after each row of $N_{FEC_TI}(n, s)$ data cells is written from the TBI to the CDL (as described in Section 7.1.5.4), a set of $(N_{FEC_TI_MAX} - N_{FEC_TI}(n, s))$ new virtual cells for the CDL shall then be input to the CDL prior to switches s_0 and s_1 moving to the next branch of the CDL. Virtual cells shall not be written to the HTI output, neither from the TBI nor from the CDL.

$N_{FEC_TI_MAX}$ corresponds to the maximum number of columns of the Twisted Block Interleaver. Hence, the switches s_0 and s_1 change their position every time a row from the Twisted Block Interleaver has been read.

The total number of cells contained in the HTI amounts to $M_{HTI} = N_r + 0.5 \times N_{FEC_TI_MAX} \times (2N_r + (L_{IU} + 1)N_{large}(N_{large} - 1) + L_{IU}(N_{IU}(N_{IU} - 1) - N_{large}(N_{large} - 1)))$ for the case that N_r is not an integer multiple of N_{IU} , which simplifies to $N_r + 0.5 \times N_{FEC_TI_MAX} \times N_r \times (N_{IU} + 1)$ for the case that N_r is an integer multiple of N_{IU} .

7.1.5.6 HTI Options

In HTI mode there are two basic options that can be selected, intra-Subframe interleaving and inter-Subframe interleaving.

- Intra-Subframe interleaving: Each interleaving frame is mapped directly to one Subframe and the interleaving frame is composed of one or more TI Blocks as shown in Figure 7.9 on the left-hand side. Each of the TI Blocks can be de-interleaved and decoded immediately after its complete reception in the receiver. This allows the maximum bit-rate for the PLP to be increased. This option is signaled as **L1D_plp_HTI_inter_subframe** = 0. For this option, the number of TI Blocks per interleaving frame is set to $N_{TI} = \text{L1D_plp_HTI_num_ti_blocks} + 1$, and $N_{IU} = 1$.
- Inter-Subframe interleaving: Each interleaving frame contains one TI Block and is mapped to multiple Subframes. Figure 7.9 shows on the right-hand side an example in which one interleaving frame is mapped onto two Subframes. This gives greater time diversity for low data-rate services. This option is signaled in the L1 signaling by **L1D_plp_HTI_inter_subframe** = 1. For this option, the number of TI Blocks per interleaving frame is set to $N_{TI} = 1$, and $N_{IU} = \text{L1D_plp_HTI_num_ti_blocks} + 1$.

Observe that in case of **L1D_plp_HTI_num_ti_blocks** being set to 0 (i.e. $N_{TI} = 1$), each interleaving frame contains one TI Block and is mapped directly to one Subframe, irrespective of the value of **L1D_plp_HTI_inter_subframe** (in the middle of Figure 7.9).

Note that the HTI in its entirety; i.e., including Cell Interleaver, Twisted Block Interleaver, and Convolutional Delay Line, shall not be in use when **L1D_plp_TI_mode** = '00' (see Table 9.23).

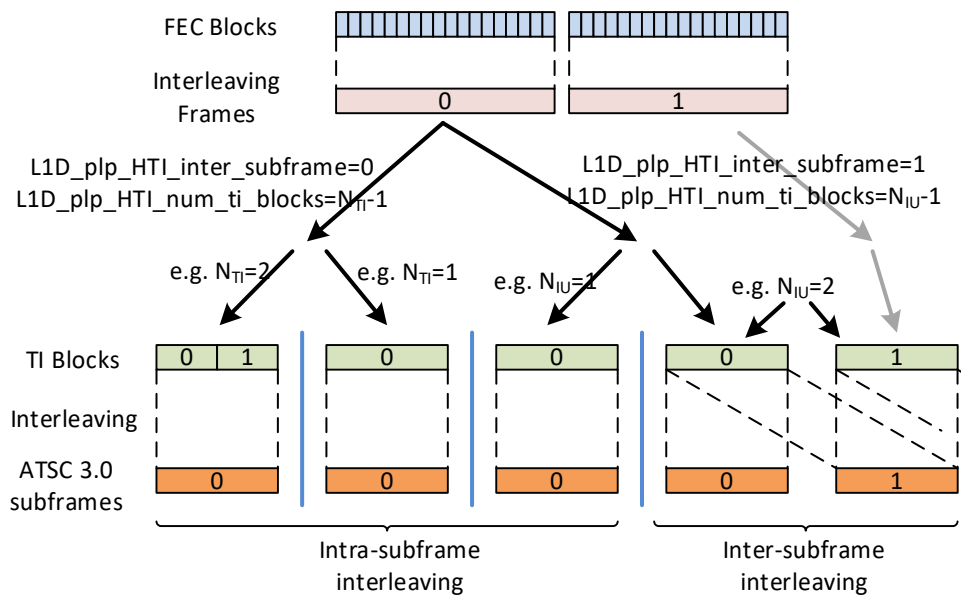

Figure 7.9 Example of HTI for **L1D_plp_HTI_inter_subframe** = 0 and 1, and for **L1D_plp_HTI_num_ti_blocks** = 0 and 1.

7.1.5.7 Initial State of the HTI's CDL for Inter-Subframe Interleaving

For HTI with inter-Subframe interleaving, the initial contents of the HTI memory (i.e., the CDL) shall be defined as follows.

Define $M_{CDL} = (N_{IU}(N_{IU} - 1)L_{IU} + N_{large}(N_{large} - 1))/2$. A total number of $\eta_{MOD} \times M_{CDL}$ bits shall be generated using the same PRBS generator described in Section 5.2.3, starting from the initial state. η_{MOD} is the modulation order as defined in Table 6.14, and shall be used according to the chosen modulation of the respective PLP. These bits shall be mapped to QAM cells according to Section 6.3, forming a sequence of M_{CDL} initialization cells g_q . The initialization cells g_q shall be input in order directly into the CDL according to the following procedure.

- Initialization cell inputs shall begin with the first delay branch (i.e., branch 1). No initialization cells shall be input to branch 0.
- Immediately after each initialization cell is input to the current branch of the CDL, $N_{FEC_TI_MAX} - 1$ virtual cells shall be input to the same branch of the CDL.
- Branch i of the CDL shall receive:
 - 0 initialization cells if $i = 0$
 - $i \times (L_{IU} + 1)$ initialization cells if $N_{large} > 0$ and $0 < i < N_{large}$
 - $i \times L_{IU}$ initialization cells if $N_{large} > 0$ and $N_{large} \leq i < N_{IU}$
 - $i \times L_{IU}$ initialization cells if $N_{large} = 0$ and $0 < i < N_{IU}$
- Each branch of the CDL shall receive all of its initialization cells before moving on to the next branch of the CDL.

When a CDL in an HTI is initialized, interleaving frame 0 for the corresponding PLP shall be considered to begin in the first Subframe of actual transmission for the PLP following HTI initialization. All interleaving frames for that PLP that are considered to begin in Subframes prior to that first Subframe of actual transmission shall be considered to contain a TI block that contains exactly one FEC Block (i.e., $N_{FEC_TI}(n, s) = 1$ for $-N_{IU} < n < 0$ and $s = 0$).

7.2 Framing

7.2.1 Overview

The framing block takes inputs from one or more physical layer pipes in the form of data cells, and outputs Frame symbols. Frame symbols represent a set of frequency domain content prior to optional frequency interleaving, followed by pilot insertion, and then conversion to a time domain OFDM symbol via an IFFT and guard interval insertion.

7.2.2 Frame Structure

7.2.2.1 Frame Components

A Frame shall consist of a combination of three basic components as shown in Figure 7.10.

- One bootstrap, located at the beginning of each Frame. The bootstrap shall be created as described in [2]. Further details of the bootstrap are described in Section 8.6. The exact time period from the start of a bootstrap to the start of the next bootstrap that matches the same major and minor bootstrap versions shall be an integer multiple of the sample time of the baseband sampling rate indicated by the first bootstrap.
- One Preamble, located immediately following the bootstrap. The Preamble shall contain L1 control signaling applicable to the remainder of the Frame. The Preamble is described in detail in Section 7.2.5.

- One or more Subframes shall be located immediately following the Preamble. If multiple Subframes are present in a Frame, then those Subframes shall be concatenated together in time as shown in Figure 7.10.

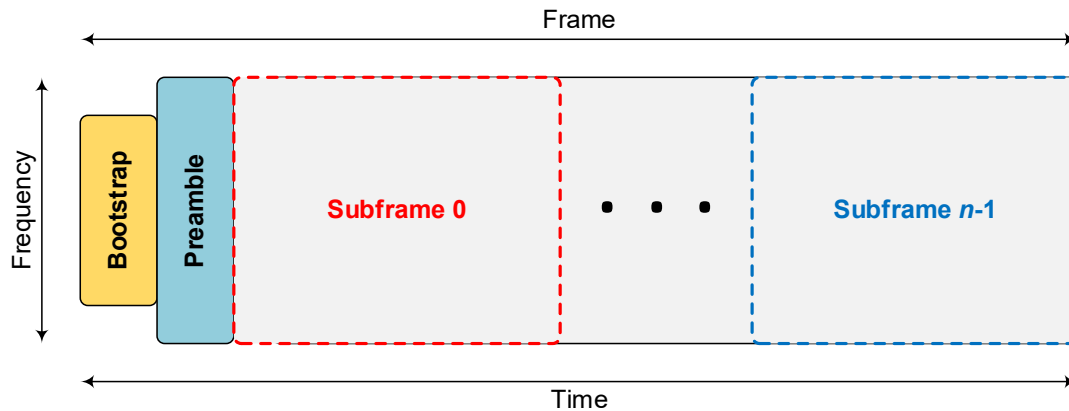

Figure 7.10 Frame structure.

A Subframe shall consist of a set of time-frequency resources within a Frame. A Subframe shall span the full range of configured carriers in the frequency dimension and shall consist of an integer number of OFDM symbols in the time dimension. The waveform attributes of a Subframe constitute a *Subframe type*, with those waveform attributes defined as: the FFT size, the GI length, the scattered pilot pattern, the number of useful carriers (N_{oC}), whether or not frequency interleaving is enabled for the Subframe, and whether the Subframe is SISO, MISO, or MIMO. When a Subframe is configured for MISO, the waveform attributes defining the Subframe type of that Subframe additionally shall include the number of transmitters ($N_{TX} \in \{2,3,4\}$) and the time domain span of the filters ($N_{MISO} \in \{64,256\}$). A Subframe's waveform attributes shall remain fixed over the duration of that Subframe. A Frame may contain multiple Subframes of the same Subframe type and/or multiple Subframes of different Subframe types. Subframes within the same Frame may have different numbers of OFDM symbols. The FFT size and the signaled GI length of the Preamble and the FFT size and the signaled GI length of the first Subframe of a Frame shall be the same.

A particular PLP shall be mapped only to Subframes of the same Subframe type. When a PLP is time-interleaved across multiple Subframes within an RF channel, those Subframes shall be of the same Subframe type and may be located in the same Frame and/or different Frames. Note that this means there may be more Subframes in a Frame than PLPs, indeed the number of Subframes in a Frame may exceed the maximum number of PLPs, however the maximum number of PLPs is as defined in Section 5.1.1, regardless of the number of Subframes in a Frame.

7.2.2.2 Frame Duration

The duration of a Frame shall be specified in one of two ways, time-aligned or symbol-aligned.

A time-aligned Frame shall use the signaled guard interval length for each Subframe within the Frame to define a minimum guard interval length for each non-Preamble OFDM symbol within a Frame. An overall Frame length shall be signaled for a time-aligned Frame, where the Frame length shall be equal to the sum of the lengths of the bootstrap, the Preamble and the Subframe(s) contained within the Frame. A time-aligned Frame can be recognized by signaling of `L1B_frame_length_mode=0`.

A symbol-aligned Frame shall use the signaled guard interval lengths for OFDM symbols and shall not insert any extra samples into any guard intervals within the Frame or into any other portions of the Frame. A symbol-aligned Frame can be recognized by signaling of **L1B_frame_length_mode=1**.

The maximum duration of a Frame shall be 5s. The minimum duration of a Frame shall be 50 ms.

7.2.2.3 Subframe Duration

The minimum duration of a Subframe shall be the greater of 20ms or the duration in ms of $4 \times D_Y$ data and Subframe boundary symbols of that Subframe. At least $4 \times D_Y$ data and Subframe boundary symbols shall be present in every Subframe.

7.2.3 Number of Carriers

The number of carriers NoC shall be defined by the equation $NoC = NoC_{max} - C_{red_coeff} \times C_{unit}$ where C_{red_coeff} is a positive integer indicating a coefficient to multiply by a control unit value to determine the number of carriers to be reduced. C_{red_coeff} ranges from 0 to 4 and is signaled using the parameters **L1B_preamble_reduced_carriers**, **L1B_first_sub_reduced_carriers**, and **L1D_reduced_carriers** for the Preamble symbols following the first Preamble symbol, the first Subframe of the Frame, and the second and subsequent Subframes of the Frame, respectively. The maximum number of carriers in a symbol is denoted by NoC_{max} . The control unit C_{unit} takes a value of 96 for 8K FFT, 192 for 16K FFT and 384 for 32K FFT, respectively.

Note that the active relative carrier indices for a particular configuration will range from 0 to $NoC_{max} - C_{red_coeff} \times C_{unit} - 1$, while the active absolute carrier indices for the same configuration will range from $C_{red_coeff} \times C_{unit} / 2$ to $NoC_{max} - C_{red_coeff} \times C_{unit} / 2 - 1$.

Table 7.1 shows the values for NoC for various values of C_{red_coeff} . The value of NoC_{max} can be inferred from the table when $C_{red_coeff}=0$, that is 6913 for 8K FFT, 13825 for 16K FFT and 27649 for 32K FFT.

Table 7.1 Number of Carriers NoC and Occupied Bandwidth

C_{red_coeff}	Number of Carriers (NoC)			Occupied Bandwidth		
	8K FFT	16K FFT	32K FFT	bsr_coefficient = 2	bsr_coefficient = 5	bsr_coefficient = 8
0	6913	13825	27649	5.832844	6.804984	7.777125
1	6817	13633	27265	5.751844	6.710484	7.669125
2	6721	13441	26881	5.670844	6.615984	7.561125
3	6625	13249	26497	5.589844	6.521484	7.453125
4	6529	13057	26113	5.508844	6.426984	7.345125

7.2.4 Frame Symbol Types

Each Subframe shall consist of a combination of the following types of symbols in the stated order from the beginning of the Subframe to the end of the Subframe.

- Subframe boundary symbol (zero or one)
- Data symbols
- Subframe boundary symbol (zero or one)

Note that Subframe boundary symbols may not be present in a Subframe, and that a Subframe may consist of only data symbols.

7.2.4.1 Subframe Boundary Symbols

Subframe boundary symbols shall have a greater scattered pilot density than do data symbols in order to facilitate accurate channel estimation at a receiver.

The first symbol of a Subframe shall always be a Subframe boundary symbol except when either of the following conditions is satisfied, in which case the first symbol of the Subframe may optionally be configured as a Subframe boundary symbol.

- The Subframe is immediately preceded by a Preamble symbol **and** the Preamble symbol and Subframe use the same Subframe type waveform attributes (as defined in Section 7.2.2.1) excluding the attribute of whether or not frequency interleaving is enabled (i.e., the frequency interleaver enabled/disabled settings for the Preamble and the Subframe are not required to be the same).
- The considered Subframe is immediately preceded by another Subframe within the same Frame **and** both Subframes have the same Subframe type (as defined in Section 7.2.2.1) excluding the attribute of whether or not frequency interleaving is enabled **and** the last symbol of the preceding Subframe is a Subframe boundary symbol.

The last symbol of a Subframe shall always be a Subframe boundary symbol except when the following condition is satisfied, in which case the last symbol of the Subframe may optionally be configured as a Subframe boundary symbol.

- The considered Subframe is immediately followed by another Subframe within the same Frame **and** both Subframes have the same Subframe type (as defined in Section 7.2.2.1) excluding the attribute of whether or not frequency interleaving is enabled **and** the first symbol of the following Subframe is a Subframe boundary symbol.

The presence or absence of a Subframe boundary symbol at the beginning and end of each Subframe shall be explicitly signaled.

7.2.4.2 Data Symbols

A data symbol shall have a scattered pilot density according to the scattered pilot pattern that is indicated in the control signaling for the corresponding Subframe.

The following condition shall be satisfied when the FFT size for a Subframe is 32K:

- The sum of the number of data and Subframe boundary symbols present in the Subframe shall always be even, except for the first Subframe of a Frame where the sum of the number of Preamble, Subframe boundary and data symbols shall be even.

When present at the beginning of a Subframe, a Subframe boundary symbol shall immediately precede any data symbols for the same Subframe.

When present at the end of a Subframe, a Subframe boundary symbol shall immediately follow the last data symbol for the same Subframe.

7.2.5 Preamble

The Preamble shall consist of one or more Preamble symbols, which carry the L1 signaling data for the Frame.

7.2.5.1 Preamble Symbol(s)

The FFT size, guard interval and scattered pilot pattern of the Preamble symbols shall be signaled by the bootstrap as detailed in Section 9.1.

The number of Preamble symbols in the Preamble N_P shall be indicated by the L1 signaling.

For the first Preamble symbol, the NoC used shall be the minimum for the FFT size used for that first Preamble symbol while the NoC for the remaining Preamble symbols shall be signaled in L1-Basic.

The frequency interleaver shall always be applied to all of the Preamble symbol(s) as described in Section 7.3.

7.2.5.2 Mapping of L1 Signaling Data to Preamble Symbol(s)

L1-Basic and L1-Detail signaling data shall be encoded and modulated as described in Section 6.5.

L1-Basic cells shall be mapped only to the available cells of the first Preamble symbol, as shown in Figure 7.11. L1-Detail cells shall be interleaved and mapped to the remaining available cells of the first Preamble symbol directly after the L1-Basic cells and to the available cells of the other $(N_P - 1)$ Preamble symbols.

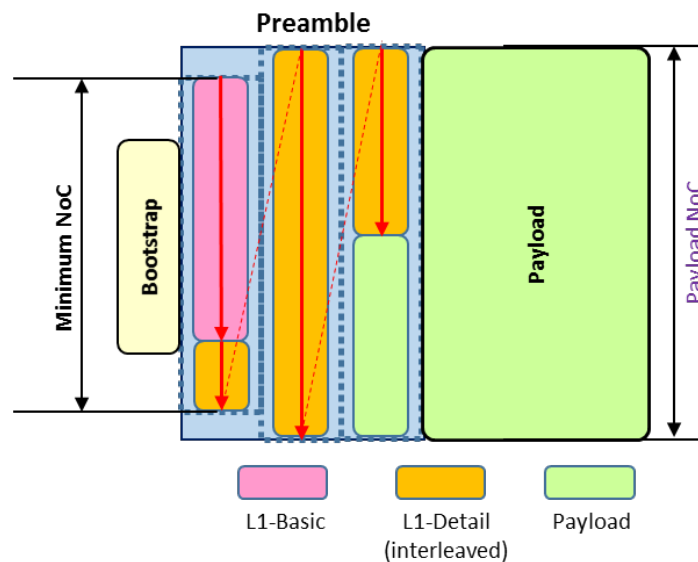

Figure 7.11 Mapping of L1-Basic and L1-Detail into Preamble symbol(s).

Modulated L1-Detail cells are interleaved and mapped to the Preamble symbols(s) as follows.

The **L1B_L1_Detail_total_cells** cells of L1-Detail shall be interleaved across all the N_P Preamble symbols. Within the first Preamble symbol, L1-Detail shall occupy the data cells that are not occupied by L1-Basic. The L1-Detail interleaver is a Block Interleaver comprised of $L_c = N_P$ columns and $L_r = \lfloor \mathbf{L1B_L1_Detail_total_cells} / N_P \rfloor$ rows.

The first $L_c \times L_r$ L1-Detail cells shall be written sequentially into the Block Interleaver row-wise and read out column by column. The relationship between the L1-Detail cells which form the interleaver input $x(m)$ and its output $y(n)$, $m, n = 0, 1, \dots, \mathbf{L1B_L1_Detail_total_cells} - 1$ is described by the following equation:

$$y(n) = \begin{cases} x(j \times L_c + i) & \text{where } n = (i \times L_r + j) \text{ and } 0 \leq n < L_r \times L_c \\ x(n) & L_r \times L_c \leq n < \mathbf{L1B_L1_Detail_total_cells} \end{cases}$$

$$\text{for } j = 0, 1, \dots, L_r - 1 \text{ and } i = 0, 1, \dots, L_c - 1.$$

The output cells of the interleaver $y(n)$ shall be mapped sequentially to the unoccupied data cells of the Preamble symbols, beginning with the first unoccupied data cell of the first Preamble symbol and filling each Preamble symbol before moving on to the next Preamble symbol until all the **L1B_L1_Detail_total_cells** are so mapped.

The available cells that are not used for L1-Detail cells in the last Preamble symbol shall be treated as available data cells when performing cell multiplexing as specified in Section 7.2.6.

7.2.5.3 Generating Preamble waveform

After frequency interleaving, the Preamble pilots shall be inserted in each Preamble symbol as described in Section 8.1.6. Then the Preamble symbol shall pass through an IFFT as described in Section 8.3, followed by addition of a guard interval as detailed in Section 8.5.

MISO or MIMO shall not be applied to any Preamble symbol(s).

LDM shall not be applied to any cells in the Preamble carrying L1-Basic or L1-Detail data but may be applied to payload data cells in the last Preamble symbol.

The FFT size and the duration of the guard interval shall be the same for each Preamble symbol and shall be as indicated by the **preamble_structure** parameter of the bootstrap as shown in Table H.1.1.

7.2.6 Cell Multiplexing

The Frame builder maps cells from the time interleaver output to the data cells of each Subframe as described in the following subsections.

7.2.6.1 Data Cell Indexing

Data cells within a Subframe shall be indexed in a one-dimensional fashion beginning at 0 for the first data cell and incrementing the index by 1 for each subsequent data cell. Data cell indexing shall begin with the first Frame symbol associated with a Subframe for the purposes of data cell multiplexing, which shall be one of the following: the final symbol of a Preamble (only possible for the first Subframe of a Frame), a Subframe boundary symbol, or a data symbol. All of the data cells within a Frame symbol shall be indexed before moving on to the following Frame symbol of the same Subframe. Within a Frame symbol, data cell indexing shall begin with the data cell that maps to the lowest index carrier and shall proceed to the data cell that maps to the next lowest index carrier, and so on until all data cells within the Frame symbol have been indexed.

Data cells shall be the cells of the OFDM symbols that are not used for pilots nor used for PAPR reduction via tone reservation (TR) (see Section 8.4.1) nor used as null cells.

Figure 7.12 shows an example of data cell indexing for a Subframe that begins with the final symbol of a Preamble, concludes with a Subframe boundary symbol, and contains data symbols between these two boundaries. In this example, multiple Preamble symbols may be contained within the Frame's Preamble, but only the final Preamble symbol is actually able to carry PLP data and has therefore been included in this example.

Similarly, Figure 7.13 shows an example data cell indexing for a Subframe that begins with a Subframe boundary symbol, concludes with a Subframe boundary symbol, and contains data symbols between these two boundaries. No Preamble symbol is associated with this latter example Subframe.

Within Figure 7.12 and Figure 7.13, the following quantities are defined:

- N_C^P is the number of available data cells in the final symbol of a Preamble.
- N_C^D is the number of available data cells in a data symbol.
- N_C^B is the number of available data cells in a Subframe boundary symbol.

- N_s^D is the number of data symbols present in a Subframe.

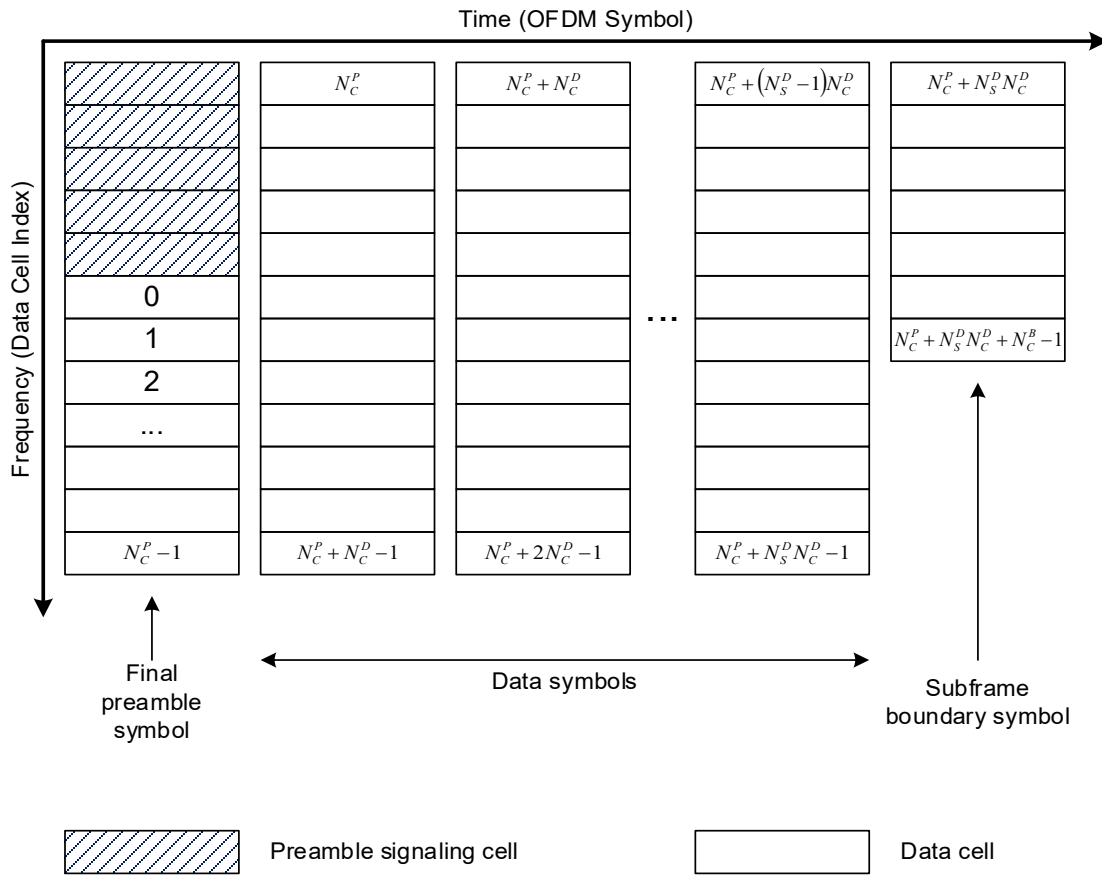

Figure 7.12 Data cell addressing when a Preamble symbol is associated with a Subframe.

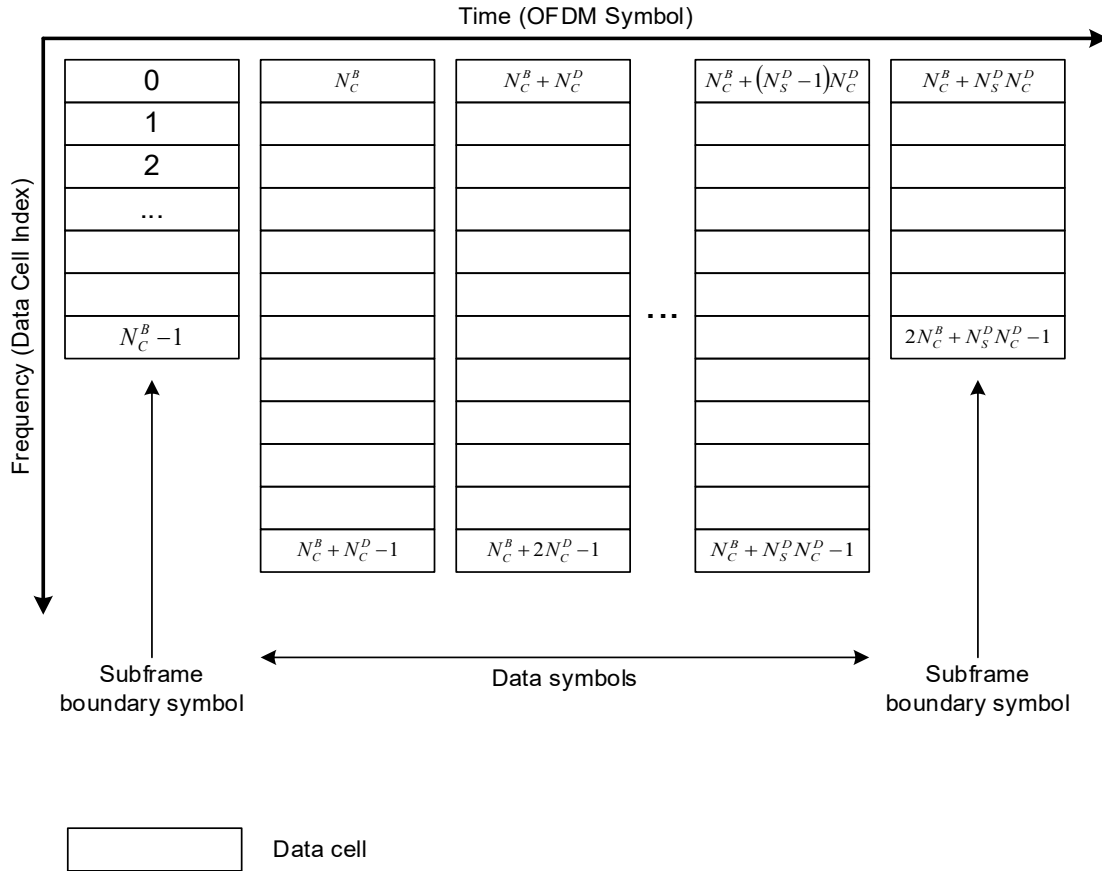

Figure 7.13 Data cell addressing when a Preamble symbol is not associated with a Subframe.

7.2.6.2 Number of Available Data Cells for Preamble Symbols

The number of available data cells per Preamble symbol (N_c^P) is a function of the following quantities.

- The Number of Carriers (NoC) is as described in Section 7.2.3.
- The number of Preamble pilots, which is a function of the Preamble pilot pattern (D_X) and the NoC .
- The number of continual pilots per Preamble symbol, which is a function of the Preamble FFT size and the NoC .
- Whether or not tone reservation is configured for peak-to-average power ratio (PAPR) reduction. The number of carriers used for TR (if configured) is a function of the FFT size as shown in Table G.1.2.

Note that the data cells in Preamble symbols are primarily used for carrying encoded and modulated L1-Basic and L1-Detail signaling. Data cells in the final Preamble symbol that do not carry L1-Basic or L1-Detail signaling can be used for carrying PLP data cells (see Sections 7.2.5.2 and 7.2.6.1).

The number of available data cells per Preamble symbol shall be as listed in Table 7.2 when tone reservation is not enabled.

When tone reservation is enabled, the number of available data cells per data symbol shall be equal to the corresponding quantities from Table 7.2 minus the number of reserved carriers for the associated FFT size as shown in Table G.1.2.

Table 7.2 Number of Available Data Cells per Preamble Symbol

FFT Size	GI Length (samples)	Pilot Pattern (D_x)	C_{red_coeff}				
			0	1	2	3	4
8K	192	16	6432	6342	6253	6164	6075
8K	384	8	6000	5916	5833	5750	5667
8K	512	6	5712	5632	5553	5474	5395
8K	768	4	5136	5064	4993	4922	4851
8K	1024	3	4560	4496	4433	4370	4307
8K	1536	4	5136	5064	4993	4922	4851
8K	2048	3	4560	4496	4433	4370	4307
16K	192	32	13296	13110	12927	12742	12558
16K	384	16	12864	12684	12507	12328	12150
16K	512	12	12576	12400	12227	12052	11878
16K	768	8	12000	11832	11667	11500	11334
16K	1024	6	11424	11264	11107	10948	10790
16K	1536	4	10272	10128	9987	9844	9702
16K	2048	3	9120	8992	8867	8740	8614
16K	2432	3	9120	8992	8867	8740	8614
16K	3072	4	10272	10128	9987	9844	9702
16K	3648	4	10272	10128	9987	9844	9702
16K	4096	3	9120	8992	8867	8740	8614
32K	192	32	26592	26220	25854	25484	25116
32K	384	32	26592	26220	25854	25484	25116
32K	512	24	26304	25936	25574	25208	24844
32K	768	16	25728	25368	25014	24656	24300
32K	1024	12	25152	24800	24454	24104	23756
32K	1536	8	24000	23664	23334	23000	22668
32K	2048	6	22848	22528	22214	21896	21580
32K	2432	6	22848	22528	22214	21896	21580
32K	3072	8	24000	23664	23334	23000	22668
32K	3072	3	18240	17984	17734	17480	17228
32K	3648	8	24000	23664	23334	23000	22668
32K	3648	3	18240	17984	17734	17480	17228
32K	4096	3	18240	17984	17734	17480	17228
32K	4864	3	18240	17984	17734	17480	17228

7.2.6.3 Number of Available Data Cells for Data Symbols

The number of available data cells per data symbol (N_C^D) is a function of the following quantities.

- The Number of Carriers (NoC) is as described in Section 7.2.3.
- The number of scattered pilots per OFDM symbol, which is a function of the scattered pilot pattern and the NoC .
- The number of continual pilots per OFDM symbol, which is a function of the FFT size and the NoC .

- Whether or not tone reservation is configured for peak-to-average power ratio (PAPR) reduction. The number of carriers used for TR (if configured) is a function of the FFT size as shown in Table G.1.2.

The number of available data cells per data symbol shall be as listed in Table 7.3 and Table 7.4 when tone reservation is not enabled. Table entries shown in brackets and italicized are for FFT size and scattered pilot pattern combinations that are not allowed (refer to Table 8.3).

When tone reservation is enabled, the number of available data cells per data symbol shall be equal to the corresponding quantities from Table 7.3 and Table 7.4 minus the number of reserved carriers for the associated FFT size as shown in Table G.1.2.

Table 7.3 Number of Available Data Cells per Data Symbol

FFT Size	C_{red_coeff}	NoC	Available data cells per data symbol							
			SP3_2	SP3_4	SP4_2	SP4_4	SP6_2	SP6_4	SP8_2	SP8_4
8K	0	6913	5711	6285	5999	6429	6287	6573	6431	6645
	1	6817	5631	6197	5915	6339	6199	6481	6341	6552
	2	6721	5552	6110	5832	6250	6112	6390	6252	6460
	3	6625	5473	6023	5749	6161	6025	6299	6163	6368
	4	6529	5394	5936	5666	6072	5938	6208	6074	6276
16K	0	13825	11423	12573	11999	12861	12575	13149	12863	13293
	1	13633	11263	12397	11831	12681	12399	12965	12683	13107
	2	13441	11106	12224	11666	12504	12226	12784	12506	12924
	3	13249	10947	12049	11499	12325	12051	12601	12327	12739
	4	13057	10789	11875	11333	12147	11877	12419	12149	12555
32K	0	27649	22847	(25149)	N/A	N/A	25151	(26301)	25727	(26589)
	1	27265	22527	(24797)	N/A	N/A	24799	(25933)	25367	(26217)
	2	26881	22213	(24451)	N/A	N/A	24453	(25571)	25013	(25851)
	3	26497	21895	(24101)	N/A	N/A	24103	(25205)	24655	(25481)
	4	26113	21579	(23753)	N/A	N/A	23755	(24841)	24299	(25113)

Table 7.4 Number of Available Data Cells per Data Symbol

FFT Size	C_{red_coeff}	NoC	Available data cells per data symbol							
			SP12_2	SP12_4	SP16_2	SP16_4	SP24_2	SP24_4	SP32_2	SP32_4
8K	0	6913	6575	6717	6647	6753	(6719)	(6789)	6755	6807
	1	6817	6483	6623	6554	6660	(6625)	(6694)	6661	6714
	2	6721	6392	6530	6462	6565	(6532)	(6600)	6567	6619
	3	6625	6301	6437	6370	6473	(6439)	(6506)	6474	6524
	4	6529	6210	6344	6278	6378	(6346)	(6412)	6380	6429
16K	0	13825	13151	13437	13295	13509	13439	13581	13511	13617
	1	13633	12967	13249	13109	13320	13251	13391	13322	13428
	2	13441	12786	13064	12926	13134	13066	13204	13136	13239
	3	13249	12603	12877	12741	12946	12879	13015	12948	13051
	4	13057	12421	12691	12557	12759	12693	12827	12761	12861
32K	0	27649	26303	(26877)	26591	(27021)	26879	(27165)	27023	(27237)
	1	27265	25935	(26501)	26219	(26643)	26503	(26785)	26645	(26856)
	2	26881	25573	(26131)	25853	(26271)	26133	(26411)	26273	(26481)
	3	26497	25207	(25757)	25483	(25895)	25759	(26033)	25897	(26102)
	4	26113	24843	(25385)	25115	(25521)	25387	(25657)	25523	(25725)

7.2.6.4 Number and Position of Available Data Cells for Subframe Boundary Symbols

The following terms are defined:

- N_{Data}^B is the total number of data cells (non-pilot cells) including both null and active data cells in a Subframe boundary symbol.
- NoA_{SBS} is the number of active data cells in a Subframe boundary symbol. The number of available data cells per Subframe boundary symbol for cell multiplexing purposes is $N_C^B = NoA_{SBS}$.
- N_{Null}^B is the number of null cells in a Subframe boundary symbol. $N_{Null}^B = N_{Data}^B - NoA_{SBS}$

The total number of data cells in a Subframe boundary symbol (N_{Data}^B) shall be as listed in Table 7.5 and Table 7.6 when tone reservation is not enabled. Table entries shown in brackets and italicized are for FFT size and scattered pilot pattern combinations that are not allowed (refer to Table 8.3).

When tone reservation is enabled, the total number of data cells in a Subframe boundary symbol shall be equal to the corresponding quantities from Table 7.5 and Table 7.6 minus the number of reserved carriers for the associated FFT size as shown in Table G.1.2 and Table G.1.3, that is, 72 for 8K FFT, 144 for 16K FFT and 288 for 32K FFT size respectively.

Table 7.5 Total Number of Data Cells in a Subframe Boundary Symbol

FFT Size	C_{red_coeff}	NoC	Total data cells in a Subframe boundary symbol							
			SP3_2	SP3_4	SP4_2	SP4_4	SP6_2	SP6_4	SP8_2	SP8_4
8K	0	6913	4560	4560	5136	5136	5712	5712	6000	6000
	1	6817	4496	4496	5064	5064	5632	5632	5916	5916
	2	6721	4433	4433	4993	4993	5553	5553	5833	5833
	3	6625	4370	4370	4922	4922	5474	5474	5750	5750
	4	6529	4307	4307	4851	4851	5395	5395	5667	5667
16K	0	13825	9120	9120	10272	10272	11424	11424	12000	12000
	1	13633	8992	8992	10128	10128	11264	11264	11832	11832
	2	13441	8867	8867	9987	9987	11107	11107	11667	11667
	3	13249	8740	8740	9844	9844	10948	10948	11500	11500
	4	13057	8614	8614	9702	9702	10790	10790	11334	11334
32K	0	27649	18240	(18240)	N/A	N/A	22848	(22848)	24000	(24000)
	1	27265	17984	(17984)	N/A	N/A	22528	(22528)	23664	(23664)
	2	26881	17734	(17734)	N/A	N/A	22214	(22214)	23334	(23334)
	3	26497	17480	(17480)	N/A	N/A	21896	(21896)	23000	(23000)
	4	26113	17228	(17228)	N/A	N/A	21580	(21580)	22668	(22668)

Table 7.6 Total Number of Data Cells in a Subframe Boundary Symbol

FFT Size	C_{red_coeff}	NoC	Total data cells in a Subframe boundary symbol							
			SP12_2	SP12_4	SP16_2	SP16_4	SP24_2	SP24_4	SP32_2	SP32_4
8K	0	6913	6288	6288	6432	6432	(6576)	(6576)	6648	6648
	1	6817	6200	6200	6342	6342	(6484)	(6484)	6555	6555
	2	6721	6113	6113	6253	6253	(6393)	(6393)	6463	6463
	3	6625	6026	6026	6164	6164	(6302)	(6302)	6371	6371
	4	6529	5939	5939	6075	6075	(6211)	(6211)	6279	6279
16K	0	13825	12576	12576	12864	12864	13152	13152	13296	13296
	1	13633	12400	12400	12684	12684	12968	12968	13110	13110
	2	13441	12227	12227	12507	12507	12787	12787	12927	12927
	3	13249	12052	12052	12328	12328	12604	12604	12742	12742
	4	13057	11878	11878	12150	12150	12422	12422	12558	12558
32K	0	27649	25152	(25152)	25728	(25728)	26304	(26304)	26592	(26592)
	1	27265	24800	(24800)	25368	(25368)	25936	(25936)	26220	(26220)
	2	26881	24454	(24454)	25014	(25014)	25574	(25574)	25854	(25854)
	3	26497	24104	(24104)	24656	(24656)	25208	(25208)	25484	(25484)
	4	26113	23756	(23756)	24300	(24300)	24844	(24844)	25116	(25116)

The number of active data cells in a Subframe boundary symbol (NoA_{SBS}) is dependent on the amplitude of the scattered pilots signaled with **L1D_scattered_pilot_boost**.

The number of active data cells in a Subframe boundary symbol for each **L1_scattered_pilot_boost** value shall be as listed in Table F.1.1 to Table F.1.10. Table entries shown in brackets and italicized are for FFT size and scattered pilot pattern combinations that are not allowed (refer to Table 8.3).

When tone reservation is enabled, the number of active data cells in a Subframe boundary symbol shall be equal to the corresponding quantities from Table F.1.1 to Table F.1.10 minus the

number of reserved carriers for the associated FFT size as shown in Table G.1.2 and Table G.1.3, that is, 72 for 8K FFT, 144 for 16K FFT and 288 for 32K FFT size respectively.

The number of null cells in a Subframe boundary symbol (N_{Null}^B) is also dependent on the amplitude of the scattered pilots of the Subframe (determined from the value signaled by **L1D_scattered_pilot_boost**). The number of null cells in a Subframe boundary symbol can be obtained by subtracting the number of active data cells in a Subframe boundary symbol from the total number of data cells (Table 7.5 and Table 7.6). The number of null cells in a Subframe boundary symbol shall be signaled by **L1D_sbs_null_cells**.

The active data cells shall be centered within the total data cells, with half of the null cells being positioned at each band edge as shown in Figure 7.14.

- Null cells shall occupy the $\lfloor N_{Null}^B/2 \rfloor$ lowest-frequency data carriers and the $\lfloor N_{Null}^B/2 \rfloor$ highest-frequency data carriers.
- The data carriers between these two sets of null carriers shall be active data carriers and shall be indexed as described in Section 7.2.6.1 for the purposes of data cell multiplexing.

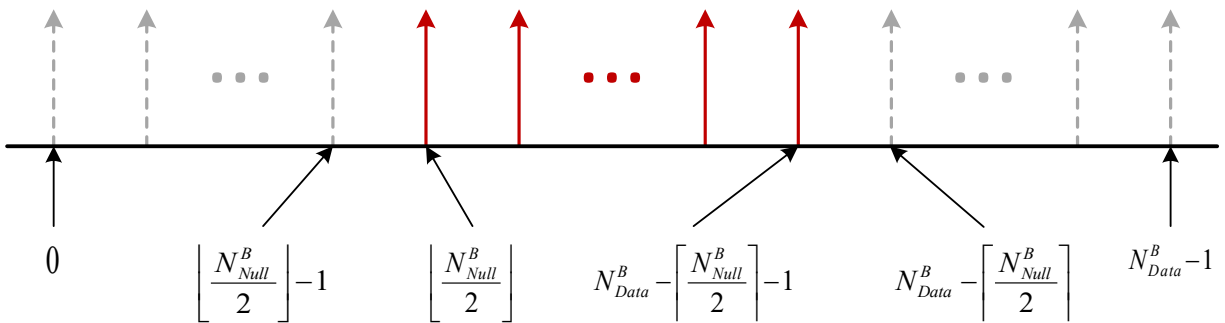

Figure 7.14 Data carrier indices for null and active data carriers.

7.2.6.5 Insertion of Dummy Modulation Values

Depending upon the exact Subframe configuration and PLP multiplexing parameters, the available data cells of a Subframe may be fully or partially occupied by PLP data. In the event that not all of the available data cells have PLP data mapped to them, it is important that these unoccupied data cells are modulated rather than remaining as unmodulated null cells in order to ensure a constant transmit power. This is accomplished by assigning pseudo-random dummy modulation values to the unoccupied data cells.

Unoccupied data cells could conceivably occur anywhere within a Subframe, depending upon the exact PLP multiplexing parameters. Therefore, all of the available data cells of a Subframe shall first be filled with dummy modulation values, and then the cell multiplexing process shall overwrite the dummy modulation values of occupied data cells with actual PLP data. This approach ensures that every available data cell in a Subframe is modulated either by a PLP cell or by a dummy modulation value.

Let N_{cell} be the total number of available data cells in a Subframe with those data cells being indexed from 0 to $N_{cell} - 1$ as described in Section 7.2.6.1.

Let d_i be the dummy modulation value for the data cell with index i ($0 \leq i < N_{cell}$).

Let b_i ($0 \leq i < N_{cell}$) represent the i th value of the Baseband Packet scrambling sequence described in Section 5.2.3.

Then the dummy modulation value for the i th data cell ($0 \leq i < N_{cell}$) shall be calculated as given in the following pair of equations.

$$\text{Re}\{d_i\} = 1 - 2 \times b_i$$

$$\text{Im}\{d_i\} = 0$$

Each of the N_{cell} available data cells in the Subframe shall have its corresponding dummy modulation value assigned to it prior to any PLP data being multiplexed into the Subframe. Following the insertion of these dummy modulation values, PLP data belonging to the current Subframe shall be mapped to the corresponding data cells allocated for that PLP data and shall overwrite the dummy modulation values previously assigned to those data cells.

Note that the available data cells in the first Subframe of a Frame might begin in the final Preamble symbol of that Frame as specified in Section 7.2.5.2.

7.2.6.6 PLP Types

Each PLP that is not an LDM Enhanced PLP shall be one of the following two PLP types: a non-dispersed PLP or a dispersed PLP.

The data cells of a non-dispersed PLP shall be allocated to contiguous data cell indices of the Subframe. That is, all of the data cell indices between the lowest data cell index allocated to a non-dispersed PLP and the highest data cell index allocated to the same non-dispersed PLP, inclusive, shall also be allocated to the same non-dispersed PLP.

A dispersed PLP shall consist of two or more subslices. The data cells within a single subslice of a dispersed PLP shall be allocated to contiguous data cell indices of the Subframe. However, two consecutive subslices of the same dispersed PLP shall not have contiguous data cell indices with each other. That is, the difference between the lowest data cell index allocated to a subslice of a dispersed PLP and the highest data cell index allocated to the immediately preceding subslice of the same dispersed PLP shall be greater than one.

The type of a particular PLP **L1D_plp_type** shall be signaled independently for each Subframe in which that PLP appears. A PLP shall not be constrained to be of the same type for two different Subframes in which that PLP appears.

When LDM is used, **L1D_plp_type** shall be signaled only for Core PLPs. Enhanced PLPs shall not have a specific PLP type associated with them.

7.2.6.7 PLP Positioning

The starting position of a PLP **L1D_plp_start** may lie anywhere within a Subframe regardless of the type of the PLP. The starting position of a PLP shall be the index of the data cell assigned to hold the first data cell value of the PLP.

The length of a PLP **L1D_plp_size** shall indicate the total number of data cells contained by the PLP for the current Subframe.

The starting position and length of a PLP in a Subframe shall be independent of and shall be signaled independently of the starting position and length of the same PLP in all other Subframes. The starting position and length of every PLP present in a Subframe shall be signaled, regardless of whether or not LDM is used.

A PLP's cell allocation parameters (i.e. the starting position, length, and subslicing parameters (the subslicing parameters shall only be included for a dispersed PLP)) shall be configured so that

all data cells allocated to that PLP lie within the range of valid data cell indices for the current Subframe.

Each data cell within a Subframe shall be allocated to a maximum of one PLP per LDM layer.

Let S_{PLP} be the size and P_{start} be the starting position of a non-dispersed PLP within a Subframe. The non-dispersed PLP's input data cells 0 through $S_{PLP} - 1$, inclusive, shall be mapped respectively to data cell indices P_{start} through $P_{start} + S_{PLP} - 1$, inclusive, within the Subframe.

7.2.6.8 Subslicing

A dispersed PLP shall be divided into two or more subslices. Each subslice shall occupy a set of contiguous data cell indices, but the highest data cell index of a subslice shall be non-contiguous to the lowest data cell index of the following subslice of the same PLP.

Every subslice, with the possible exception of the final subslice, of a particular dispersed PLP within a Subframe shall have the same non-zero size. The size of the final subslice of a dispersed PLP within a Subframe shall be greater than zero and less than or equal to the size of the other subslices of the same PLP within the same Subframe. The subslice interval (**L1D_plp_subslice_interval**) between the lowest data cell index of a subslice of a dispersed PLP and the lowest data cell index of the following subslice of the same PLP shall be the same for all subslices of that PLP within a Subframe.

The number of subslices, subslice size, and subslice interval for a dispersed PLP shall be independent of and shall be signaled independently of the number of subslices, subslice size and subslice interval of all other dispersed PLPs within the same Subframe.

The number of subslices, subslice size, and subslice interval for a dispersed PLP in a Subframe shall be independent of and shall be signaled independently of the number of subslices, subslice size, and subslice interval of the same PLP in all other Subframes.

When LDM is used, the number of subslices and subslice interval shall be signaled only for dispersed Core PLPs.

Let S_{PLP} be the size, P_{start} be the starting position, $N_{subslices}$ be the number of subslices, and $I_{subslice}$ be the subslice interval of a dispersed PLP within a Subframe. The subslice size of the dispersed PLP can be calculated as $S_{subslice} = \lceil S_{PLP}/N_{subslices} \rceil$. Data cell k of the dispersed PLP's input data ($0 \leq k < S_{PLP}$) shall be mapped to data cell index $P_{start} + \lfloor k/S_{subslice} \rfloor \times I_{subslice} + k \bmod S_{subslice}$ within the Subframe.

A non-dispersed PLP shall not be subsliced and shall not have any subslicing parameters associated with it.

7.2.7 PLP Multiplexing Approaches within a Subframe

This section contains an overview on how the cell multiplexing method described in Section 7.2.6 can be used to enable specific styles of PLP multiplexing, complete with an illustrative example of each multiplexing approach. The examples included here use the example data cell indices shown in Figure 7.15. Layered Division Multiplexing of PLPs is considered in detail in Section 7.2.7.4.

000	010	020	030	040	050	060	070	080	090	100	110	120	130	140	150	160	170	180	190	200	210	220	230	240	250
001	011	021	031	041	051	061	071	081	091	101	111	121	131	141	151	161	171	181	191	201	211	221	231	241	251
002	012	022	032	042	052	062	072	082	092	102	112	122	132	142	152	162	172	182	192	202	212	222	232	242	252
003	013	023	033	043	053	063	073	083	093	103	113	123	133	143	153	163	173	183	193	203	213	223	233	243	253
004	014	024	034	044	054	064	074	084	094	104	114	124	134	144	154	164	174	184	194	204	214	224	234	244	254
005	015	025	035	045	055	065	075	085	095	105	115	125	135	145	155	165	175	185	195	205	215	225	235	245	255
006	016	026	036	046	056	066	076	086	096	106	116	126	136	146	156	166	176	186	196	206	216	226	236	246	256
007	017	027	037	047	057	067	077	087	097	107	117	127	137	147	157	167	177	187	197	207	217	227	237	247	257
008	018	028	038	048	058	068	078	088	098	108	118	128	138	148	158	168	178	188	198	208	218	228	238	248	258
009	019	029	039	049	059	069	079	089	099	109	119	129	139	149	159	169	179	189	199	209	219	229	239	249	259

Figure 7.15 Data cell indices used for illustrative multiplexing examples.

7.2.7.1 Overview

7.2.7.1.1 Simple Multiplexing of PLPs

The simplest multiplexing strategy is when there is only one Core PLP, and the output of the time interleaver is mapped to data cells which are ordered in data symbols within the Subframe. This is described in Section 7.2.7.2. For all other cases apart from this single PLP per Subframe case, there are various ways to multiplex the multiple PLPs onto the Frame. The following sections describe the multiplexing techniques used in this specification. The specific multiplexing techniques defined are:

- Time division multiplexing (TDM), described in Section 7.2.7.3
- Layered division multiplexing (LDM), described in Section 7.2.7.4
- Frequency division multiplexing (FDM), described in Section 7.2.7.5

7.2.7.1.2 Complex Multiplexing of PLPs

LDM can be combined in many ways, some of them quite complex. Complex LDM examples are described in Sections 7.2.7.4.2 to 7.2.7.4.5. Furthermore, there are various combinations of the multiplexing techniques that can be used. Time and frequency division multiplexing (TFDM) is described in Section 7.2.7.6.

7.2.7.2 Single Physical Layer Pipe

The simplest structure for a physical layer Frame is when there is only one PLP per Subframe.

Table 7.7 and Figure 7.16 show an example of the cell multiplexing parameters and the resulting graphical view of the cell multiplexing.

Table 7.7 Example Parameters for the Cell Multiplexing of a Single PLP

L1D_plp_id	L1D_plp_size	L1D_plp_type	L1D_plp_start	L1D_plp_num_sublices	L1D_plp_sublice_interval
A	260	0 (Non-dispersed)	000	N/A	N/A

A000	A010	A020	A030	A040	A050	A060	A070	A080	A090	A100	A110	A120	A130	A140	A150	A160	A170	A180	A190	A200	A210	A220	A230	A240	A250
A001	A011	A021	A031	A041	A051	A061	A071	A081	A091	A101	A111	A121	A131	A141	A151	A161	A171	A181	A191	A201	A211	A221	A231	A241	A251
A002	A012	A022	A032	A042	A052	A062	A072	A082	A092	A102	A112	A122	A132	A142	A152	A162	A172	A182	A192	A202	A212	A222	A232	A242	A252
A003	A013	A023	A033	A043	A053	A063	A073	A083	A093	A103	A113	A123	A133	A143	A153	A163	A173	A183	A193	A203	A213	A223	A233	A243	A253
A004	A014	A024	A034	A044	A054	A064	A074	A084	A094	A104	A114	A124	A134	A144	A154	A164	A174	A184	A194	A204	A214	A224	A234	A244	A254
A005	A015	A025	A035	A045	A055	A065	A075	A085	A095	A105	A115	A125	A135	A145	A155	A165	A175	A185	A195	A205	A215	A225	A235	A245	A255
A006	A016	A026	A036	A046	A056	A066	A076	A086	A096	A106	A116	A126	A136	A146	A156	A166	A176	A186	A196	A206	A216	A226	A236	A246	A256
A007	A017	A027	A037	A047	A057	A067	A077	A087	A097	A107	A117	A127	A137	A147	A157	A167	A177	A187	A197	A207	A217	A227	A237	A247	A257
A008	A018	A028	A038	A048	A058	A068	A078	A088	A098	A108	A118	A128	A138	A148	A158	A168	A178	A188	A198	A208	A218	A228	A238	A248	A258
A009	A019	A029	A039	A049	A059	A069	A079	A089	A099	A109	A119	A129	A139	A149	A159	A169	A179	A189	A199	A209	A219	A229	A239	A249	A259

Figure 7.16 Example of cell multiplexing for a single PLP per Subframe.

7.2.7.3 Time Division Multiplexing (TDM)

The concatenation in time of multiple PLPs within a Subframe can be achieved simply by using non-dispersed PLPs instead of dispersed PLPs.

Table 7.8 and Figure 7.17 show the cell multiplexing parameters and the resulting graphical view for an example of the time division multiplexing of six PLPs.

Table 7.8 Example Parameters for Time Division Multiplexing of PLPs

L1D_plp_id	L1D_plp_size	L1D_plp_type	L1D_plp_start	L1D_plp_num_sublices	L1D_plp_subslice_interval
A	12	Non-dispersed	000	N/A	N/A
B	24	Non-dispersed	012	N/A	N/A
C	80	Non-dispersed	036	N/A	N/A
D	52	Non-dispersed	116	N/A	N/A
E	60	Non-dispersed	168	N/A	N/A
F	32	Non-dispersed	228	N/A	N/A

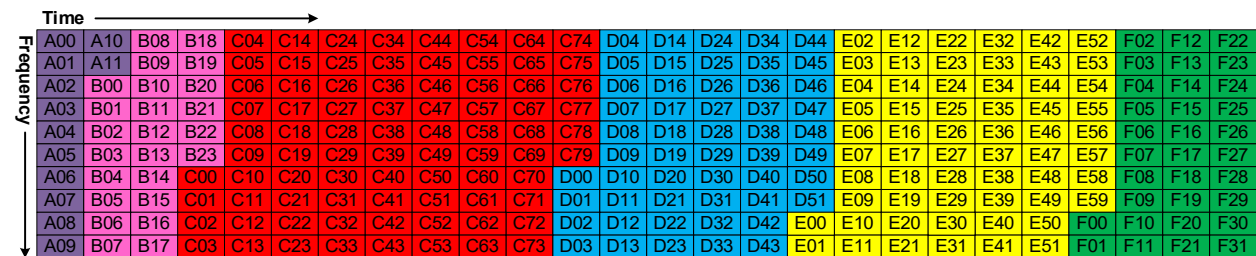

Figure 7.17 Example of time division multiplexing of PLPs.

7.2.7.4 Layered Division Multiplexing (LDM)

When Layered Division Multiplexing (LDM) is used, each PLP present in a Subframe shall be classified as either a Core PLP or an Enhanced PLP. The LDM layer with which a PLP is associated shall be indicated by **L1D_plp_layer**. There shall always be one Core Layer, regardless of whether or not LDM is used. There shall be no Enhanced Layers when LDM is not used. There shall be one or more Enhanced Layers when LDM is used. The current version of the specification shall have a maximum of one Enhanced Layer for LDM.

Each Core PLP within a Subframe shall represent one time interleaver group. Each Core PLP shall therefore belong to exactly one time interleaver group within a Subframe and shall have directly associated L1 control signaling specifying the time interleaving parameters for that PLP. Each Enhanced PLP shall be associated with one or more time interleaver groups within a Subframe and shall not have directly associated L1 control signaling related to time interleaving. An Enhanced PLP shall follow the time interleaving of the time interleaving group(s) with which it is associated. Note that **L1D_plp_start** and **L1D_plp_size** of Enhanced PLPs are defined with respect to before time interleaving.

Time interleaver groups shall be implicitly indexed within a Subframe according to the order in which the associated Core PLPs appear in the control signaling for that Subframe. That is, the first Core PLP whose parameter set appears in the control signaling for the corresponding Subframe shall be indexed as **TI_Group_0**, the second Core PLP whose parameter set appears in the control signaling for the corresponding Subframe shall be indexed as **TI_Group_1**, and so on.

Note that the implicit indices of and the ordering of the implicit indices of time interleaver groups shall be independent of the `L1D_plp_id` values for Core PLPs present in a Subframe.

Time interleaving, cell multiplexing, and subslicing (if applicable) shall be performed based on Core PLPs. An Enhanced PLP shall follow the time interleaving and cell multiplexing of the Core PLP(s) (time interleaver group(s)) with which the Enhanced PLP is associated.

An injection level shall be signaled for each Enhanced PLP. Injection levels shall not be signaled for Core PLPs.

When an Enhanced PLP is layered-division multiplexed with at least one Core PLP that uses the HTI mode, then that Enhanced PLP shall have an integer number of FEC Blocks within each Subframe.

When an Enhanced PLP is spread over multiple TI groups, either all Core PLPs associated with that Enhanced PLP shall use the HTI mode or else all Core PLPs associated with that Enhanced PLP shall use the no TI Mode. When all Core PLPs associated with that Enhanced PLP use the HTI mode, each such Core PLP shall use the intra-Subframe interleaving mode (i.e., `L1D_plp_hti_inter_subframe` = 0). When all Core PLPs associated with that Enhanced PLP use the no TI Mode, each such Core PLP shall consist of an integer number of FEC Blocks within each Subframe in which that Core PLP is layered-division multiplexed with that Enhanced PLP. This implies that the use of dummy modulation values as described in Section 7.2.6.5 will likely be required in this scenario in order to achieve an integer number of FEC Blocks per Subframe.

7.2.7.4.1 Simple LDM Example

Figure 7.18 shows the simplest possible LDM example, with one Core PLP (`L1D_PLP_id_0`) and one Enhanced PLP (`L1D_PLP_id_1`), each with the same starting position and length. With only one Core PLP, there is also only one time interleaver group (`TI_Group_0`). When LDM is applied within a Subframe containing only one Core PLP, Convolutional Time Interleaver mode (see Section 7.1.3) may be used.

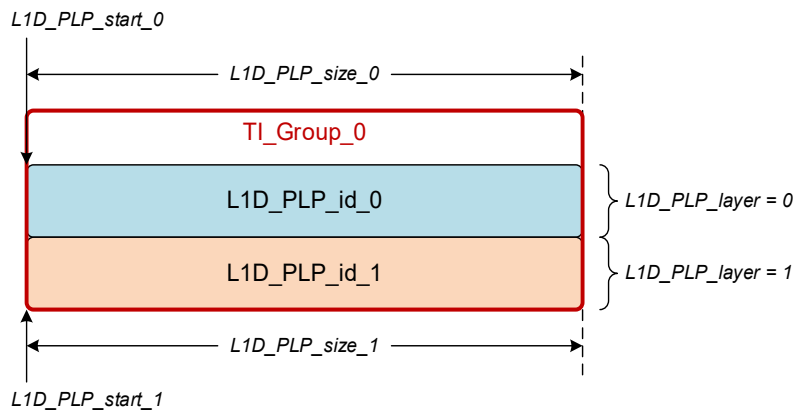

Figure 7.18 LDM Example #1 (1 Core PLP, 1 Enhanced PLP).

7.2.7.4.2 Two Core PLPs LDM Example

Figure 7.19 shows a more complex LDM example, with two Core PLPs (`L1D_PLP_id_0` and `L1D_PLP_id_1`) and one Enhanced PLP (`L1D_PLP_id_2`). The Enhanced PLP (`L1D_PLP_id_2`) is exactly aligned with the corresponding Core PLP (`L1D_PLP_id_1`), with both PLPs having the same start position and length. There are two time interleaver groups (`TI_Group_0` and `TI_Group_1`), one for each Core PLP.

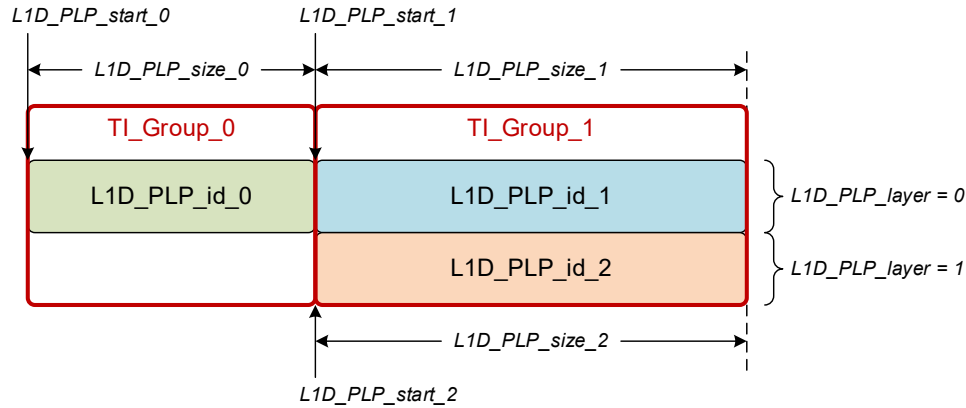

Figure 7.19 LDM Example #2 (2 Core PLPs, 1 Enhanced PLP).

7.2.7.4.3 Non-aligned Enhanced Layer LDM Example

Figure 7.20 shows an LDM example of Enhanced PLPs that are not aligned with Core PLPs. There are two time interleaver groups, one for each Core PLP.

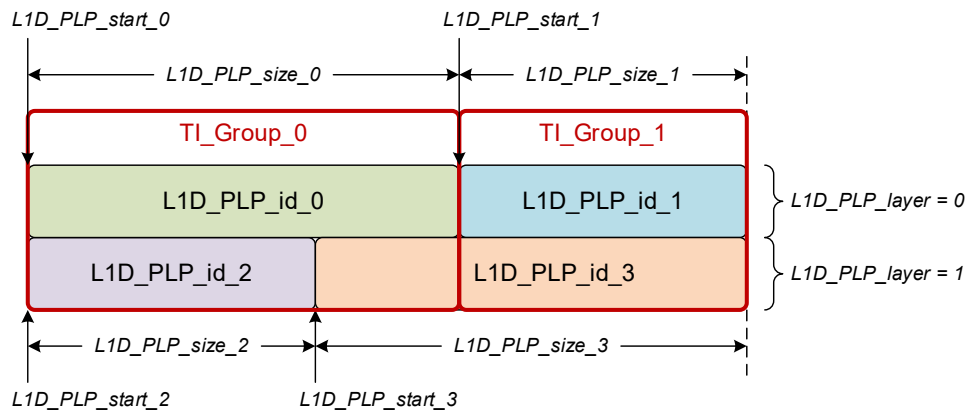

Figure 7.20 LDM Example #3 (2 Core PLPs, 2 Enhanced PLPs).

L1D_PLP_id_2 is an Enhanced PLP associated with TI_Group_0, which can be easily determined since $L1D_PLP_start_0$ and $L1D_PLP_start_2$ are equal, and $L1D_PLP_size_2$ is less than $L1D_PLP_size_0$ (thereby implying that L1D_PLP_id_2 is fully contained within TI_Group_0). L1D_PLP_id_2 is layered-division multiplexed into the first $L1D_PLP_size_2$ data cells of TI_Group_0.

L1D_PLP_id_3 is an Enhanced PLP associated with both TI_Group_0 and TI_Group_1. $L1D_PLP_start_3$ corresponds to a data cell index that is associated with TI_Group_0, according to the cell multiplexing parameters specified for L1D_PLP_id_0. Since L1D_PLP_id_3 is too long to completely fit into TI_Group_0, L1D_PLP_id_3 automatically continues on into the next implicitly indexed time interleaver group (TI_Group_1).

The first $L1D_PLP_size_0 - L1D_PLP_size_2$ data cells of L1D_PLP_id_3 are layered-division multiplexed into the last $L1D_PLP_size_0 - L1D_PLP_size_2$ data cells of TI_Group_0. The last $L1D_PLP_size_3 - (L1D_PLP_size_0 - L1D_PLP_size_2)$ data cells of L1D_PLP_id_3 are layered-division multiplexed into TI_Group_1.

7.2.7.4.4 Three Enhanced PLPs LDM Example

Figure 7.21 shows an LDM example with one Core PLP ($L1D_PLP_id_0$) and three Enhanced PLPs ($L1D_PLP_id_1$, $L1D_PLP_id_2$, $L1D_PLP_id_3$), all of which belong to the same time interleaving group (TI_Group_0). $L1D_PLP_start_0$ and $L1D_PLP_start_1$ are equal. Both $L1D_PLP_start_2$ and $L1D_PLP_start_3$ correspond to data cell indices that are associated with TI_Group_0 , according to the cell multiplexing parameters specified for $L1D_PLP_id_0$. The sum of the lengths of the three Enhanced PLPs ($L1D_PLP_size_1$, $L1D_PLP_size_2$, $L1D_PLP_size_3$) is equal to the length of the Core PLP ($L1D_PLP_size_0$), so all PLPs fit within the same time interleaving group.

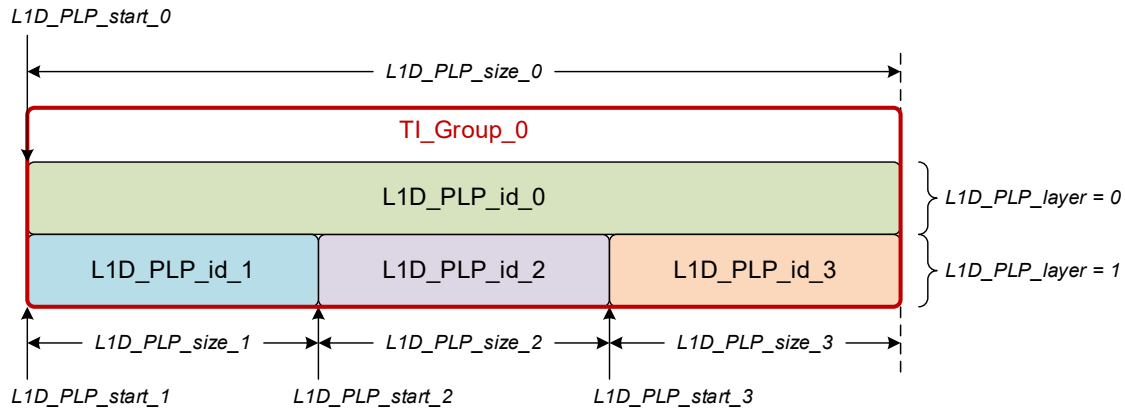

Figure 7.21 LDM Example #4 (1 Core PLP, 3 Enhanced PLPs).

7.2.7.4.5 Three Core PLPs LDM Example

Figure 7.22 shows an LDM example with three Core PLPs ($L1D_PLP_id_0$, $L1D_PLP_id_1$, $L1D_PLP_id_2$) and one Enhanced PLP ($L1D_PLP_id_3$). There are three time interleaver groups (TI_Group_0 , TI_Group_1 , TI_Group_2), one for each of the three Core PLPs.

$L1D_PLP_id_3$ is an Enhanced PLP associated with all three time interleaver groups. $L1D_PLP_start_3$ is equal to $L1D_PLP_start_0$, which implies that the first $L1D_PLP_size_0$ data cells of $L1D_PLP_id_3$ are associated with TI_Group_0 . Since $L1D_PLP_id_3$ is too long to completely fit into TI_Group_0 , $L1D_PLP_id_3$ automatically continues on into the next implicitly indexed time interleaver group (TI_Group_1) and then continues even further into the following implicitly indexed time interleaver group (TI_Group_2). The middle $L1D_PLP_size_1$ data cells of $L1D_PLP_id_3$ are associated with TI_Group_1 , and the last $L1D_PLP_size_2$ data cells of $L1D_PLP_id_3$ are associated with TI_Group_2 .

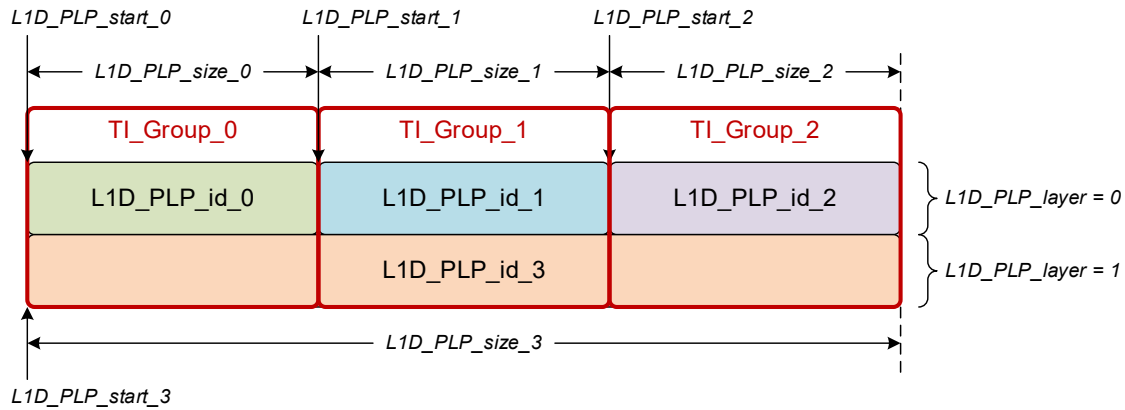

Figure 7.22 LDM Example #5 (3 Core PLPs, 1 Enhanced PLP).

7.2.7.4.6 Insertion of Enhanced Layer Dummy Modulation Values in HTI Mode with Layered Division Multiplexing

Let a PLP group represent the complete set of PLPs associated with delivering a particular end product to receivers within a Subframe. A PLP group will contain at least one Core PLP and will also contain one or more Enhanced PLPs when Layered-Division Multiplexing is in use.

When time interleaving is configured as HTI mode, which uses an integer number of FEC Blocks for the actual PLP data, the total number of cells of Core PLP(s) may be different from that of Enhanced PLP(s) within a particular PLP group depending on ModCod configuration of each PLP. In such cases, Enhanced Layer dummy modulation values shall be inserted after the actual data cells of the last Enhanced PLP in the PLP group so that the total number of Enhanced Layer cells shall be the same as the total number of Core Layer cells in that PLP group as shown in Figure 7.23. Dummy modulation values shall not be inserted in the Core Layer since TI groups are configured with respect to Core PLP(s).

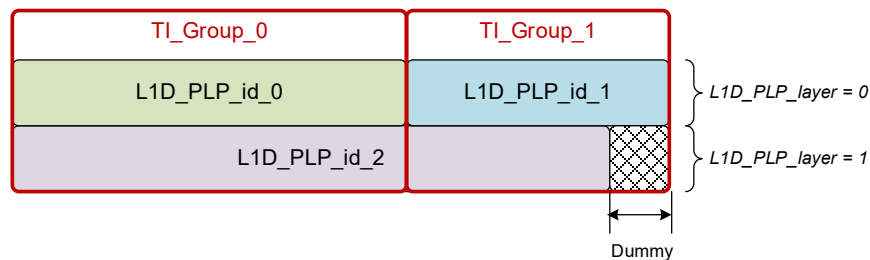

Figure 7.23 Example Insertion of Enhanced Layer dummy modulation values when the HTI mode is used with Layered-Division Multiplexing.

The insertion of Enhanced Layer dummy modulation values shall be performed after the BICM stages and before Core PLP(s) and Enhanced PLP(s) are combined. For the generation of Enhanced Layer dummy modulation values, the Baseband Packet scrambling sequence defined in Section 5.2.3 shall be used and this scrambling sequence shall be reinitialized for each relevant PLP group.

Then, this sequence shall be modulated by using the same constellation mapping that is used for the last Enhanced PLP in the current PLP group.

The Enhanced Layer dummy modulation values shall have the same power as the immediately preceding Enhanced PLP within the same PLP group so that the same scaling factor and normalizing factor in Table 6.16 are applied for the Enhanced Layer dummy modulation values. Note that when the number of cells allocated to each PLP varies from Subframe to Subframe due to variable bit rates, the number of Enhanced Layer dummy modulation values would also change from Subframe to Subframe.

7.2.7.5 Frequency Division Multiplexing (FDM)

The frequency division multiplexing of multiple PLPs within a Subframe can be achieved by using dispersed PLPs with appropriate parameter settings. To achieve FDM, the subslice interval of each dispersed PLP is set to the number of data cells per data symbol for the current Subframe configuration. The number of subslices is set such that the resulting size of each subslice is less than the number of data cells per data symbol for the current Subframe configuration.

Note that the frequency division multiplexing effect can only be achieved if frequency interleaving of the corresponding Subframe is disabled. In addition, for full frequency division multiplexing, PLP data cannot be mapped to data cells that belong either to the final Preamble symbol (only applicable for the first Subframe of a Frame) or to a Subframe boundary symbol, since those data cells will not be aligned in frequency with the allocated data cells that belong to a normal data symbol. It may be possible to map PLP data to the final Preamble symbol (for the first Subframe of a Frame) and/or to a Subframe boundary symbol if the limitation of a frequency division multiplexed PLP being mapped to a different portion of the frequency spectrum at the beginning and/or end of a Subframe is acceptable. For example, a low-power receiver would have to receive the full system bandwidth of a transmitted signal at the beginning of a Frame anyway in order to correctly receive and decode the Preamble (L1-Basic and L1-Detail), so could also receive a frequency division multiplexed PLP that begins in the final Preamble symbol and which is then confined to only a specific portion of the frequency spectrum for the remainder of the Subframe (which would thus permit lower-power receiver processing of those data symbols).

Table 7.9 and Figure 7.24 show the cell multiplexing parameters and the resulting graphical view for an example of the frequency division multiplexing of six PLPs. Note that **L1D_plp_num_subslices** is set equal to one less than the number of subslices for a given dispersed PLP (refer to Section 9.3.4), so the actual number of subslices for a dispersed PLP is one more than the number given in Table 7.9.

Table 7.9 Example Parameters for Frequency Division Multiplexing of PLPs

L1D_plp_id	L1D_plp_size	L1D_plp_type	L1D_plp_start	L1D_plp_num_subslices	L1D_plp_subslice_interval
A	26	Dispersed	0	25	10
B	52	Dispersed	1	25	10
C	26	Dispersed	3	25	10
D	78	Dispersed	4	25	10
E	26	Dispersed	7	25	10
F	52	Dispersed	8	25	10



Figure 7.24 Example of frequency division multiplexing of PLPs.

7.2.7.6 Time Frequency Division Multiplexing (TFDM)

A mix of time and frequency division multiplexing can be accomplished by applying the approach used to achieve frequency division multiplexing (Section 7.2.7.5) and setting PLP size and subslicing parameters such that the resulting PLP mappings are multiplexed not only in frequency but also in time.

One or more non-dispersed PLPs can also optionally be included in a TFDM Subframe.

The same limitations on frequency division multiplexing as described in Section 7.2.7.5 are also applicable to TFDM, although data cells belonging either to the final Preamble symbol or to a Subframe boundary symbol could be allocated to a time division multiplexed PLP at either the beginning or end of a Subframe, in order to facilitate the full frequency division multiplexing of PLPs within the middle portion of a Subframe.

Table 7.10 and Figure 7.25 show the cell multiplexing parameters and the resulting graphical view for an example of the time and frequency division multiplexing of six PLPs. Note that **L1D_plp_num_subslices** is set equal to one less than the number of subslices for a given dispersed PLP (refer to Section 9.3.4), so the actual number of subslices for a dispersed PLP is one more than the number given in Table 7.10.

Table 7.10 Example Parameters for Time and Frequency Division Multiplexing of PLPs

L1D_plp_id	L1D_plp_size	L1D_plp_type	L1D_plp_start	L1D_num_subslices	L1D_subslice_interval
A	50	Non-dispersed	0	N/A	N/A
B	33	Dispersed	50	10	10
C	42	Dispersed	53	20	10
D	20	Dispersed	55	3	10
E	85	Dispersed	95	16	10
F	30	Dispersed	160	9	10

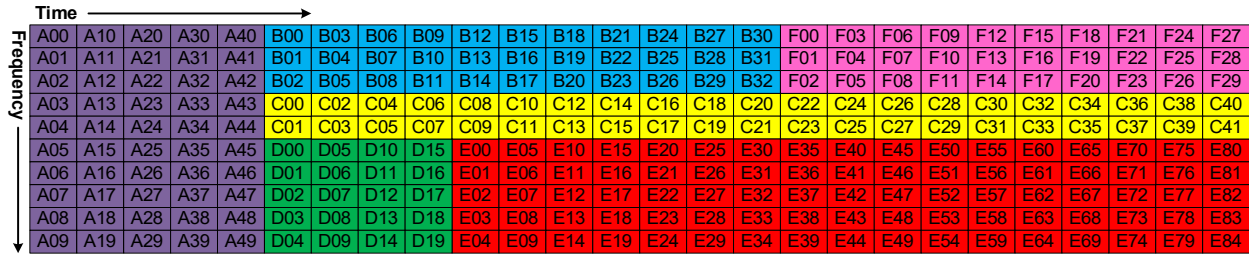

Figure 7.25 Example of time and frequency division multiplexing of PLPs.

7.3 Frequency Interleaving

Frequency interleaving shall operate on the data cells of one OFDM symbol. Use of the Frequency Interleaver (FI) for the data and Subframe boundary symbols of a particular Subframe is optional and is signaled with **L1D_frequency_interleaver**. However, the frequency interleaver shall always be used for Preamble symbols.

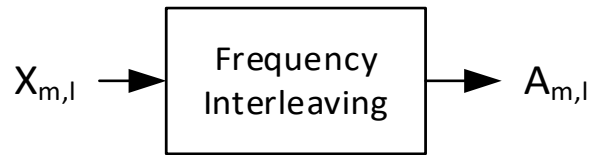

Figure 7.26 Frequency interleaving overview.

In Figure 7.26 the input cells of the FI (the output cells of the framing) are defined by $X_{m,l} = (x_{m,l,0}, x_{m,l,1}, x_{m,l,2}, \dots, x_{m,l,N_{data}-1})$, where $x_{m,l,q}$ denotes the cell index q of the symbol l ($l = 0, \dots, L_{Fm} - 1$) and where L_{Fm} is the number of Preamble, data and Subframe boundary symbols in the first Subframe ($m=1$) or the number of data and Subframe boundary symbols in the second and subsequent Subframe ($m > 1$). N_{data} denotes the number of data cells in a symbol as specified in Table 7.2 for Preamble symbols, Table 7.3 and Table 7.4 for data symbols, and Table 7.5 and Table 7.6 for Subframe boundary symbols. $A_{m,l} = (a_{m,l,0}, a_{m,l,1}, a_{m,l,2}, \dots, a_{m,l,N_{data}-1})$ denotes the FI output cells for symbol l of Subframe m . Note that the counters l used for symbol number and m used for Subframe index are unique to this section. In Subframe boundary symbols, the frequency interleaver shall operate on both null and active cells.

Figure 7.27, Figure 7.28 and Figure 7.29 show the FI address generator diagrams for the 8K, 16K, and 32K FFT sizes, respectively. Each FI address generator consists of three generation blocks: the (MSB) toggle (T) block, an interleaving sequence generator with a wire permutation, and a symbol offset generator. The address-check block validates whether the generated address is within the range of the allowable carrier indices for the particular OFDM symbol being frequency interleaved.

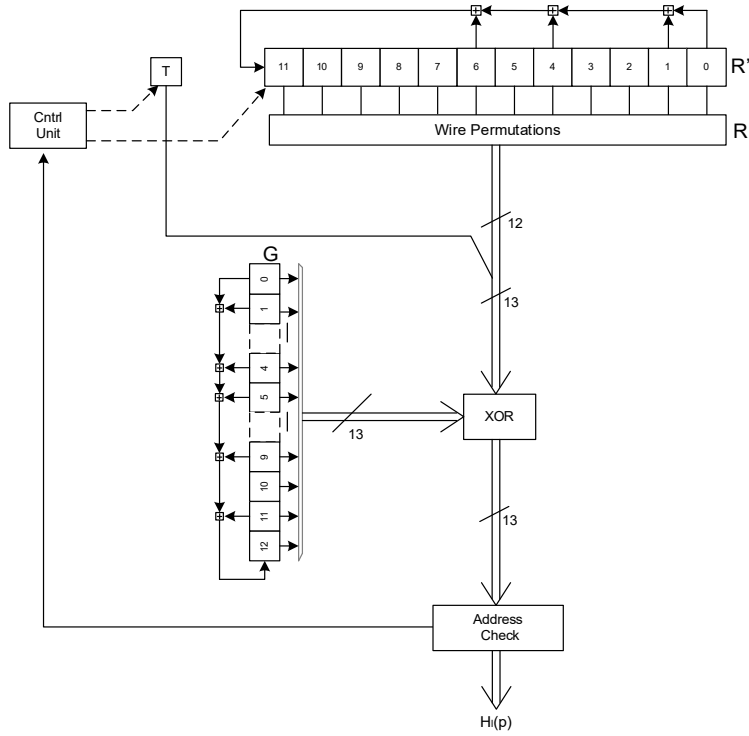

Figure 7.27 FI address generation scheme for the 8K FFT size.

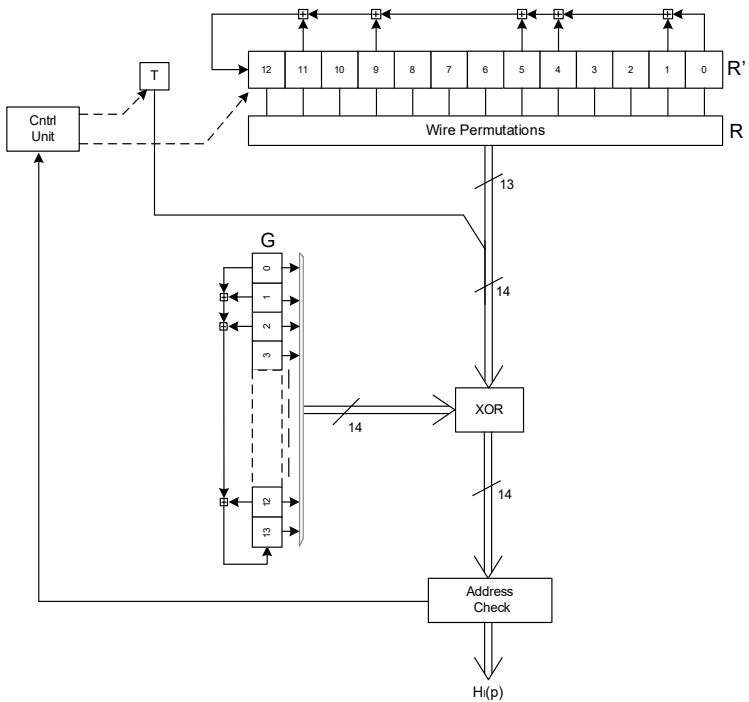

Figure 7.28 FI address generation scheme for the 16K FFT size.

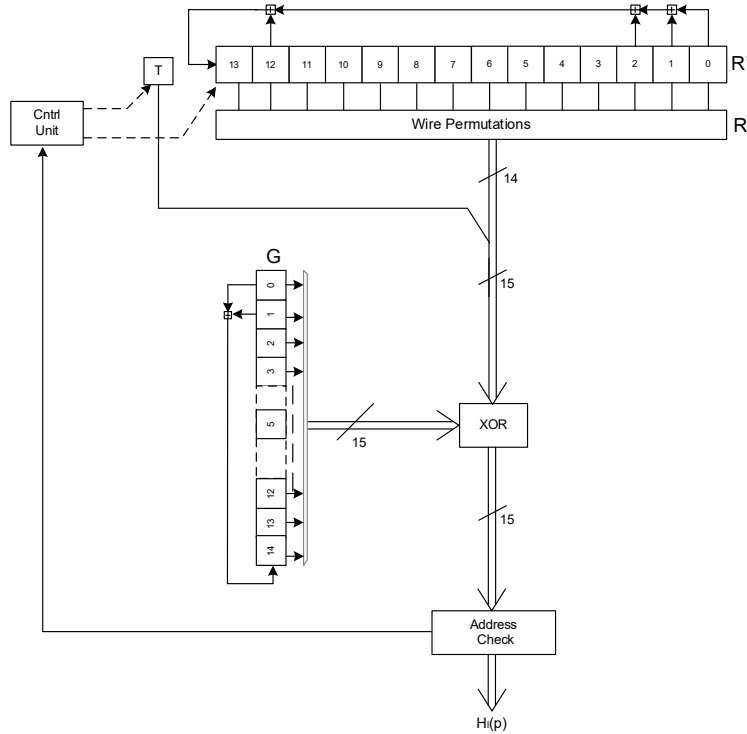

Figure 7.29 FI address generation scheme for the 32K FFT size.

In detail, in the interleaving sequence generator, an N_{r-1} bit binary word R'_i shall be generated according to the following procedure:

- $i = 0,1$: $R'_i[N_r - 2, N_r - 3, \dots, 1, 0] = [0, 0, \dots, 0, 0]$,
- $i = 2$: $R'_i[N_r - 2, N_r - 3, \dots, 1, 0] = [0, 0, \dots, 0, 1]$,
- $2 < i < M_{max}$: $\{R'_i[N_r - 3, N_r - 4, \dots, 1, 0] = R'_{i-1}[N_r - 2, N_r - 3, \dots, 2, 1]$;
 8K FFT size: $R'_i[11] = R'_{i-1}[0] \oplus R'_{i-1}[1] \oplus R'_{i-1}[4] \oplus R'_{i-1}[6]$,
 16K FFT size: $R'_i[12] = R'_{i-1}[0] \oplus R'_{i-1}[1] \oplus R'_{i-1}[4] \oplus R'_{i-1}[5] \oplus R'_{i-1}[9] \oplus R'_{i-1}[11]$,
 32K FFT size: $R'_i[13] = R'_{i-1}[0] \oplus R'_{i-1}[1] \oplus R'_{i-1}[2] \oplus R'_{i-1}[12]\}$.

where $N_r = \log_2 M_{max}$ and the parameter M_{max} is defined in Table 7.11.

Table 7.11 Values of M_{max} for the Frequency Interleaver

FFT Size	M_{max}
8K	8192
16K	16384
32K	32768

The wire permutations for each mode are defined by the relation of bit word R'_i and bit word R_i as shown in Table 7.12, Table 7.13, and Table 7.14.

Table 7.12 Wire Permutations for the 8K FFT Size

R_i bit positions	11	10	9	8	7	6	5	4	3	2	1	0
R_i bit positions (even)	5	11	3	0	10	8	6	9	2	4	1	7
R_i bit positions (odd)	8	10	7	6	0	5	2	1	3	9	4	11

Table 7.13 Wire Permutations for the 16K FFT Size

R_i bit positions	12	11	10	9	8	7	6	5	4	3	2	1	0
R_i bit positions (even)	8	4	3	2	0	11	1	5	12	10	6	7	9
R_i bit positions (odd)	7	9	5	3	11	1	4	0	2	12	10	8	6

Table 7.14 Wire Permutations for the 32K FFT Size

R_i bit positions	13	12	11	10	9	8	7	6	5	4	3	2	1	0
R_i bit positions	6	5	0	10	8	1	11	12	2	9	4	3	13	7

The symbol offset generator generates a new offset every two symbols, i.e. the symbol offset value is constant for two consecutive symbols ($2n$ and $2n + 1$). In the symbol offset generator, an N_r -bit binary word G_k shall be generated according to the following procedure:

$$\begin{aligned}
 k = 0 & : G_k[N_r - 1, N_r - 2, \dots, 1, 0] = [1, 1, \dots, 1, 1], \\
 0 < k < \lfloor L_{Fm}/2 \rfloor & : \{G_k[N_r - 2, N_r - 3, \dots, 1, 0] = G_{k-1}[N_r - 1, N_r - 2, \dots, 2, 1]; \\
 & \text{8K FFT size: } G_k[12] = G_{k-1}[0] \oplus G_{k-1}[1] \oplus G_{k-1}[4] \oplus G_{k-1}[5] \oplus G_{k-1}[9] \oplus G_{k-1}[11], \\
 & \text{16K FFT size: } G_k[13] = G_{k-1}[0] \oplus G_{k-1}[1] \oplus G_{k-1}[2] \oplus G_{k-1}[12], \\
 & \text{32K FFT size: } G_k[14] = G_{k-1}[0] \oplus G_{k-1}[1]\}.
 \end{aligned}$$

where \oplus represents an XOR operation.

From Figure 7.27, Figure 7.28, and Figure 7.29, the interleaving sequence $H_l(p)$ ($p = 0, \dots, N_{data} - 1$) to interleave the input symbol $X_{m,l}$ shall be generated as follows:

$$\begin{aligned}
 & \text{for } (l = 0; l < L_{Fm}; l = l + 1) \\
 & \{ \\
 & \quad p = 0; \\
 & \quad \text{for } (i = 0; i < M_{max}; i = i + 1) \{ \\
 & \quad \quad H_l(p) = [((i \bmod 2)2^{N_r-1} + \sum_{j=0}^{N_r-2} R_i[j]2^j) \oplus \sum_{j=0}^{N_r-1} G_{\lfloor l/2 \rfloor}[j]2^j]; \\
 & \quad \quad \text{if } (H_l(p) < N_{data}) \ p = p + 1;\} \\
 & \}
 \end{aligned}$$

Note that for the 8K and 16K FFT sizes, two different wire permutations are used. For a given symbol l the particular wire permutation used shall depend on the value of $(l \bmod 2)$ as shown in Table 7.12 and Table 7.13. This indicates that a different interleaving sequence is used every symbol. For the 32K FFT size, a single permutation shall be used as shown in Table 7.14, which indicates a different interleaving sequence is used every symbol pair.

For each FFT size, using the interleaving sequence $H_l(p)$ ($p = 0, \dots, N_{data} - 1$), the interleaved symbol $A_{m,l} = (a_{m,l,0}, a_{m,l,1}, a_{m,l,2}, \dots, a_{m,l,N_{data}-1})$ is defined as follows.

For the 32K FFT size, the input-output relation of the FI shall be

$$a_{m,l,H_l(p)} = x_{m,l,p}, \text{ for the even symbol of a symbol pair, } l = 0,2,4, \dots,$$

$$a_{m,l,p} = x_{m,l,H_l(p)}, \text{ for the odd symbol of a symbol pair, } l = 1,3,5, \dots$$

For the 8K and 16K FFT sizes, the input-output relation of the FI shall be

$$a_{m,l,p} = x_{m,l,H_l(p)}, \text{ for any symbol, } l = 0,1,2, \dots$$

The following clauses describe how the FI shall operate on a Frame basis:

- 1) On the first Preamble symbol of the Frame, the symbol offset generator and the interleaving sequence generator shall be reset, i.e. the contents of the symbol offset generator FBSR G shall be set to [1111...11] and the contents of the interleaving sequence generator FBSR R' shall be set to [0000...00].
- 2) With the exception of the first Subframe in the Frame, on the first symbol of the second and subsequent Subframes in the Frame the symbol offset generator and the interleaving sequence generator shall be reset, i.e. the contents of the symbol offset generator FBSR G shall be set to [1111...11] and the contents of the interleaving sequence generator FBSR R' shall be set to [0000...00]. The first symbol of a Subframe may be a data symbol or a Subframe boundary symbol.

8. WAVEFORM GENERATION

The block diagram of the Waveform Generation part is shown in Figure 8.1.

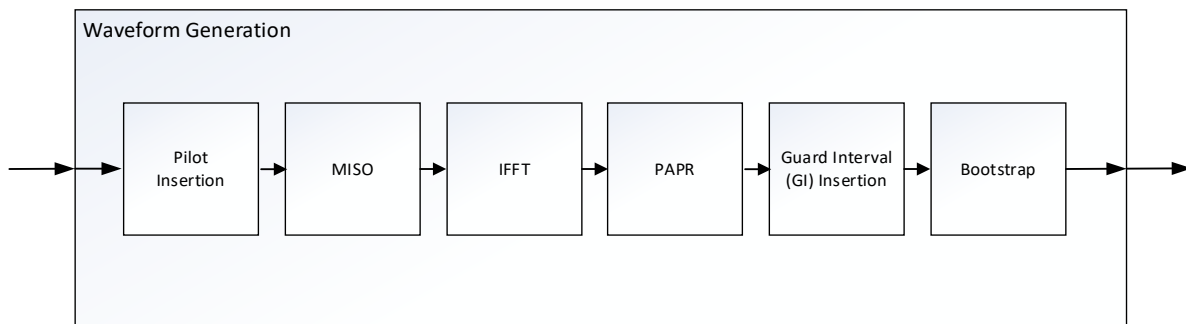

Figure 8.1 Block diagram of waveform generation.

The waveform generation section consists of pilot insertion in Section 8.1 followed by optional MISO predistortion in Section 8.2. The resultant signal is passed through an IFFT, described in Section 8.3. Optional peak-to-average-power reduction techniques may be applied as described in Section 8.4, followed by guard interval insertion as detailed in Section 8.5. Finally the bootstrap signal is prefixed to the beginning of each Frame as shown in Figure 7.10.

8.1 Pilot Insertion

8.1.1 Introduction

Various cells within the OFDM Frame are modulated with reference information whose transmitted value is known to the receiver. Cells containing reference information may be transmitted at a boosted power level. These cells are called scattered, continual, edge, Preamble or Subframe boundary pilots. The locations and amplitudes of these pilots are defined in Sections 8.1.3 to Section 8.1.7. The value of the pilot information is derived from a reference sequence, which is a series of values, one for each transmitted carrier on any given symbol, described in Section 8.1.2. The pilots can be used for synchronization, channel estimation, and phase noise estimation, among other uses.

Table 8.1 gives an overview of the different types of pilots and the symbols in which they appear, where a check mark ✓ indicates the presence of pilots in that symbol type.

Table 8.1 Presence of the Various Types of Pilots in Each Type of Symbol

Symbol Type	Preamble Pilot	Scattered Pilot	Subframe Boundary Pilot	Common Continual Pilot	Additional Continual Pilot	Edge Pilot
Preamble	✓			✓		
Data		✓		✓	✓	✓
Subframe Boundary			✓	✓	✓	✓

The following sections specify values for $c_{m,l,k}$, for certain values of m , l and k , where m and l are the Subframe and symbol number, and k is the OFDM carrier index. The symbol number l begins at zero for the first symbol of the Preamble and is incremented every symbol thereafter. The symbol number l is reset to zero at the first symbol in each Subframe.

Carrier indices can be considered to be either absolute carrier indices or relative carrier indices. Absolute carrier indices are indexed on the maximum possible number of carriers regardless of whether carrier reduction has been configured and hence range from 0 to $NoC_{max} - 1$. Relative carrier indices are indexed on the configured number of carriers (which is a function in part of the configured carrier reduction coefficient) and hence range from 0 to $NoC - 1$. Preamble, scattered, Subframe boundary, edge, and additional continual pilot locations depend on the relative carrier indices. Common continual pilot locations depend on the absolute carrier indices.

8.1.2 Reference Sequence

The pilots are modulated according to a reference sequence, r_k , where k is the relative carrier index as previously defined. This reference sequence is applied to all the pilots (i.e. scattered, both common and additional continual, edge, Preamble and boundary pilots) of each symbol of a Frame. The reference sequence can be generated according to Figure 8.2. The initial sequence shall be 0000 0000 1101 1 and shall be loaded at the start of each symbol.

The generator polynomial $G(x)$ shall be:

$$G(x) = 1 + X^9 + X^{10} + X^{12} + X^{13}$$

The first 24 values of the reference pilot sequence are 1101 1000 0000 0001 0100 0000.

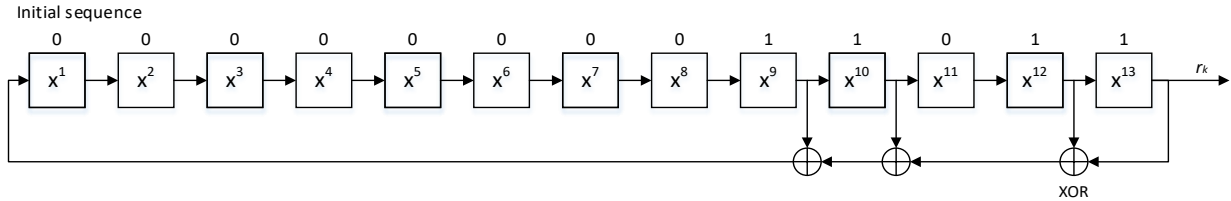

Figure 8.2 Reference sequence generator.

8.1.3 Scattered Pilot Insertion

Reference information, taken from the reference sequence, shall be transmitted in scattered pilot cells in every data symbol. Scattered pilots shall not be transmitted in Preamble symbols and Subframe boundary symbols. The locations of the scattered pilots are defined in Section 8.1.3.1, the amplitudes are defined in Section 8.1.3.2 and the modulation is defined in Section 8.1.3.3.

8.1.3.1 Locations of the scattered pilots

A given relative carrier k of the OFDM signal on a given symbol l shall be a scattered pilot if the appropriate equation below is satisfied:

$$k \bmod (D_X D_Y) = D_X (l \bmod D_Y)$$

where: the values of D_X and D_Y are as defined in Table 8.2:

The following definitions apply to the scattered pilots:

D_X : Separation of pilot bearing carriers (that is, in the frequency direction)

D_Y : Number of symbols forming one scattered pilot sequence (time direction)

SP_{a_b} : pilot pattern designation where $a = D_X$ and $b = D_Y$.

Table 8.2 Parameters D_X and D_Y Defining the SISO Scattered Pilot Patterns

Pilot Pattern	D_X	D_Y	Pilot Pattern	D_X	D_Y
SP3_2	3	2	SP12_2	12	2
SP3_4	3	4	SP12_4	12	4
SP4_2	4	2	SP16_2	16	2
SP4_4	4	4	SP16_4	16	4
SP6_2	6	2	SP24_2	24	2
SP6_4	6	4	SP24_4	24	4
SP8_2	8	2	SP32_2	32	2
SP8_4	8	4	SP32_4	32	4

The combinations of scattered pilot patterns, FFT size and guard interval which shall be allowed are defined in Table 8.3. *N/A* indicates a FFT size/ GI combination that has no valid scattered pilot pattern.

Table 8.3 Allowed Scattered Pilot Pattern for Each Combination of FFT Size and Guard Interval Pattern in SISO Mode

GI Pattern	Samples	8K FFT	16K FFT	32K FFT
GI1_192	192	SP32_2, SP32_4, SP16_2, SP16_4	SP32_2, SP32_4	SP32_2
GI2_384	384	SP16_2, SP16_4, SP8_2, SP8_4	SP32_2, SP32_4, SP16_2, SP16_4	SP32_2
GI3_512	512	SP12_2, SP12_4, SP6_2, SP6_4	SP24_2, SP24_4, SP12_2, SP12_4	SP24_2
GI4_768	768	SP8_2, SP8_4, SP4_2, SP4_4	SP16_2, SP16_4, SP8_2, SP8_4	SP32_2, SP16_2
GI5_1024	1024	SP6_2, SP6_4, SP3_2, SP3_4	SP12_2, SP12_4, SP6_2, SP6_4	SP24_2, SP12_2
GI6_1536	1536	SP4_2, SP4_4	SP8_2, SP8_4, SP4_2, SP4_4	SP16_2, SP8_2
GI7_2048	2048	SP3_2, SP3_4	SP6_2, SP6_4, SP3_2, SP3_4	SP12_2, SP6_2
GI8_2432	2432	N/A	SP6_2, SP6_4, SP3_2, SP3_4	SP12_2, SP6_2
GI9_3072	3072	N/A	SP4_2, SP4_4	SP8_2, SP3_2
GI10_3648	3648	N/A	SP4_2, SP4_4	SP8_2, SP3_2
GI11_4096	4096	N/A	SP3_2, SP3_4	SP6_2, SP3_2
GI12_4864	4864	N/A	N/A	SP6_2, SP3_2

The scattered pilot patterns are illustrated in Annex E.

8.1.3.2 Amplitudes of the Scattered Pilots

The amplitude of the scattered pilots, A_{SP} , shall be determined from the parameter **L1D_scattered_pilot_boost** and the scattered pilot pattern. The range of **L1D_scattered_pilot_boost** is defined from 0 to 4. Approximate amplitude values are listed in Table 9.17 and any amplitude value shall be calculated from the exact power values listed in Table 9.16.

8.1.3.3 Modulation of the Scattered Pilots

The phases of the scattered pilots are derived from the reference sequence given in Section 8.1.2.

The modulation value of the scattered pilots shall be given by:

$$\text{Re}\{c_{m,l,k}\} = 2 A_{SP} (1/2 - r_k)$$

$$\text{Im}\{c_{m,l,k}\} = 0$$

where A_{SP} is as defined in Section 8.1.3.2, r_k is defined in Section 8.1.2, m is the Subframe index, k is the relative index of the carriers and l is the time index of the symbols.

8.1.4 Continual Pilot Insertion

In addition to the scattered pilots, a number of continual pilots (CP) are inserted in every symbol of the Frame, including the Preamble symbols and any Subframe boundary symbols. The location of the continual pilots is described in Section 8.1.4.1, the amplitude is described in Section 8.1.4.2 and the modulation is described in Section 8.1.4.3.

8.1.4.1 Locations of the Continual Pilots

Continual pilot locations shall be determined from a common CP set with additional locations from an additional CP set.

The common continual pilot locations for 32K shall be as described in Table D.1.1 and are called the common CP set CP_{32} . The locations of the common CPs have been chosen such that they do not fall on scattered pilot (SP) locations. The locations of the common CPs do not depend on the SP pattern.

The common continual pilot locations for 8K and 16K FFT sizes shall be derived from the locations of the common CP set CP_{32} using the following equations:

$$CP_{16}(k') = \lceil CP_{32}(2k') / 2 \rceil$$

$$CP_8(k'') = \lceil CP_{32}(4k'') / 4 \rceil$$

for $k' = 0, 1, \dots, 95$ and $k'' = 0, 1, \dots, 47$ where the brackets denote the ceiling operation.

As well as the common CPs (which do not occur on SP carrier locations), a very small number of additional CPs shall be added at carrier locations that may be SP locations as described in Table D.1.4. The reason for the additional CPs is to ensure a constant number of data carriers in every data symbol, since the number of data carriers varies due to the differing number of SPs per symbol. The additional CP sets therefore depend on the scattered pilot patterns as well as the FFT size.

If the bandwidth of the total signal is reduced, that is, $C_{red_coeff} > 0$, any CP positions which fall outside of the number of carriers N_{oC} as defined in Table 7.1 shall be ignored.

The total number of common continual pilots for each FFT size and value of C_{red_coeff} are defined in Table 8.4.

Table 8.4 Number of Common Continual Pilots in Each FFT Size

C_{red_coeff}	8K	16K	32K
0	48	96	192
1	48	96	192
2	47	93	186
3	46	92	184
4	45	90	180

8.1.4.2 Amplitudes of the Continual Pilots

The common continual pilots shall be transmitted at boosted power levels, where the boosting depends on the FFT size. Table 8.5 gives the modulation amplitude A_{CP} of the common continual pilots for each FFT size. The dB values are exact, the linear values are approximate and this is shown by the use of italics.

Table 8.5 Boosting for the Common Continual Pilots

FFT size	8K	16K	32K
A_{CP}	2.67	2.67	2.67
A_{CP} (dB)	8.52	8.52	8.52

For additional continual pilots, the modulation amplitude of the scattered pilot pattern (A_{SP}) shall be used.

8.1.4.3 Modulation of the Continual Pilots

The phases of the continual pilots shall be derived from the reference sequence r_k given in Section 8.1.2. The modulation value for the continual pilots shall be given by:

$$\text{Re}\{c_{m,l,k}\} = 2 A_{CP} (1/2 - r_k)$$

$$\text{Im}\{c_{m,l,k}\} = 0.$$

where A_{CP} is as defined in Table 8.5.

8.1.5 Edge Pilot Insertion

The edge carriers, that is carriers with the relative carrier indices $k = 0$ and $k = NoC - 1$, shall be edge pilots in every symbol except for the Preamble symbol(s). Edge pilots are inserted in order to allow frequency interpolation up to the edge of the spectrum. The modulation of these cells shall be exactly the same as for the scattered pilots, as defined in Section 8.1.3.3:

$$\text{Re}\{c_{m,l,k}\} = 2 A_{SP} (1/2 - r_k)$$

$$\text{Im}\{c_{m,l,k}\} = 0.$$

8.1.6 Preamble Pilot Insertion

The D_X value used for the Preamble pilots of a Frame shall be less than or equal to the D_X value used for the scattered pilots of the first Subframe of the same Frame, in order to provide more accurate equalization for the Preamble symbols.

8.1.6.1 Locations of the Preamble Pilots

Preamble pilots shall always use $D_Y = 1$, that is the pilots shall occur in the same locations for each Preamble symbol. The D_X value of the Preamble pilots shall be signaled by **preamble_structure** in the bootstrap. Details of the valid D_X values for **preamble_structure** are described in Table H.1.1 of Annex H.

The cells in a Preamble symbol for which the relative carrier index $k \bmod D_X = 0$, shall be Preamble pilots.

8.1.6.2 Amplitudes of the Preamble Pilots

The pilot cells in the Preamble symbol(s) shall be transmitted at boosted power levels as shown in Table 8.6, which gives the exact power (in dB) and the corresponding approximate equivalent modulation amplitude A_{Preamble} for the Preamble pilots.

Table 8.6 Exact Power (dB) and Approximate Amplitudes of the Preamble Pilots

FFT Size	GI Length (samples)	Pilot Pattern (D_x)	Power (dB)	Equivalent Amplitude (A_{Preamble})
8K	192	16	5.30	1.841
8K	384	8	3.60	1.514
8K	512	6	2.90	1.396
8K	768	4	1.80	1.230
8K	1024	3	0.90	1.109
8K	1536	4	1.80	1.230
8K	2048	3	0.90	1.109
16K	192	32	6.80	2.188
16K	384	16	5.30	1.841
16K	512	12	4.60	1.698
16K	768	8	3.60	1.514
16K	1024	6	2.90	1.396
16K	1536	4	2.10	1.274
16K	2048	3	1.30	1.161
16K	2432	3	1.30	1.161
16K	3072	4	2.10	1.274
16K	3648	4	2.10	1.274
16K	4096	3	1.30	1.161
32K	192	32	6.80	2.188
32K	384	32	6.80	2.188
32K	512	24	6.20	2.042
32K	768	16	5.30	1.841
32K	1024	12	4.60	1.698
32K	1536	8	4.00	1.585
32K	2048	6	3.20	1.445
32K	2432	6	3.20	1.445
32K	3072	8	4.00	1.585
32K	3072	3	1.30	1.161
32K	3648	8	4.00	1.585
32K	3648	3	1.30	1.161
32K	4096	3	1.30	1.161
32K	4864	3	1.30	1.161

8.1.6.3 Modulation of the Preamble Pilots

The phases of the Preamble pilots shall be derived from the reference sequence given in Section 8.1.2.

The corresponding modulation shall be given by:

$$\text{Re}\{c_{m,l,k}\} = 2 A_{\text{Preamble}} (1/2 - r_k)$$

$$\text{Im}\{c_{m,l,k}\} = 0$$

where m is the Subframe index, k is the frequency index of the carriers and l is the symbol index.

8.1.7 Subframe Boundary Pilot Insertion

The pilots for Subframe boundary symbols are denser than for the adjacent normal data symbols of the same Subframe.

8.1.7.1 Locations of the Subframe Boundary Pilots

The cells in a Subframe boundary symbol for which the relative carrier indices $k \bmod D_X = 0$, except when $k = 0$ and $k = NoC - 1$, shall be Subframe boundary pilots, where D_X is the value from Table 8.2 for the scattered pilot pattern in use for that Subframe. Cells in a Subframe boundary symbol for which $k = 0$ or $k = NoC - 1$ shall be edge pilots, see Section 8.1.5.

8.1.7.2 Amplitudes of the Subframe Boundary Pilots

The Subframe boundary pilots shall be boosted by the same factor as the scattered pilots, A_{SP} .

8.1.7.3 Modulation of the Subframe Boundary Pilots

The phases of the Subframe boundary pilots shall be derived from the reference sequence given in Section 8.1.2. The corresponding modulation shall be given by:

$$\text{Re}\{c_{m,l,k}\} = 2 A_{SP} (1/2 - r_k)$$

$$\text{Im}\{c_{m,l,k}\} = 0$$

where m is the Subframe index, k is the relative carrier index of the carriers and l is the time index of the symbols.

8.2 MISO

8.2.1 Transmit Diversity Code Filter Sets

The Transmit Diversity Code Filter Set is a MISO pre-distortion technique that artificially decorrelates signals from multiple transmitters in a Single Frequency Network in order to minimize potential destructive interference. The linear frequency domain filters are all-pass filters with minimized cross-correlation under the constraints of the number of transmitters $N_{TX} \in \{2,3,4\}$ and the time domain span of the filters $N_{MISO} \in \{64,256\}$.

MISO shall be applied only to Subframe OFDM symbols and shall not be applied to the bootstrap or Preamble. The use of MISO shall be signaled with the parameters **L1B_first_sub_miso** and **L1D_miso** on a per Subframe basis.

Figure 8.3 shows a multi-transmitter system where the N_{TX} pre-distortion filters shall be applied in the frequency domain on the OFDM symbols of each Subframe.

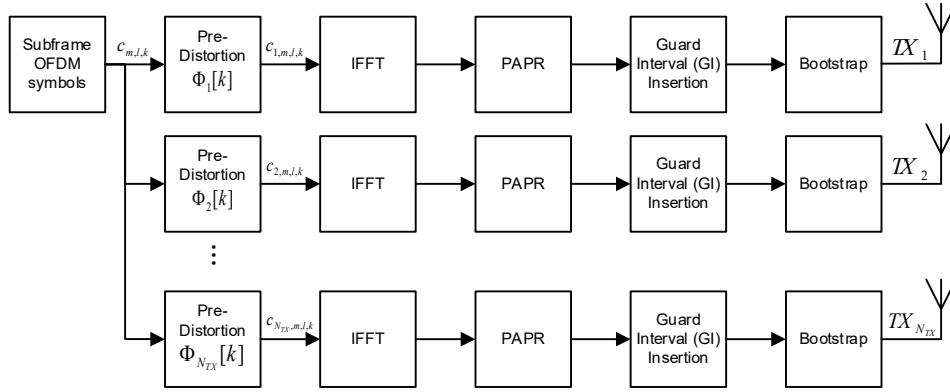

Figure 8.3 Block diagram showing example MISO transmission.

Code filter frequency domain pre-distortion function $\Phi_x[k]$ shall be determined using the Time Domain Impulse Response Vectors from Table J.1.1 and Table J.1.2 and using a zero-padded FFT of size N_{FFT}^m associated with current Subframe m :

$$\Phi_x[k] = \exp \left[j \arg \left(\sum_{n=0}^{N_{MISO}-1} h_x[n] e^{-\frac{j2\pi kn}{N_{FFT}^m}} \right) \right]; k \in \{0, \dots, NoC - 1\}, x \in \{1, \dots, N_{TX}\}$$

where $\exp()$ represents the natural exponentiation function and $\arg()$ represents the argument function which provides the angle in radians of a complex value.

Function $\Phi_x[k]$ shall be applied as:

$$c_{x,m,l,k} = \Phi_x[k] c_{m,l,k}; k \in \{0, \dots, NoC - 1\}, x \in \{1, \dots, N_{TX}\}$$

where:

k denotes the carrier number;

l denotes the OFDM symbol index which shall start from 0 at the first OFDM symbol of each Subframe;

m denotes the Subframe index, $0 \leq m < N_{SF}$;

x denotes the transmitter index, $x \in \{1, \dots, N_{TX}\}$;

$c_{m,l,k}$ is the complex modulation value for carrier k of the OFDM symbol number l in Subframe number m ;

$c_{x,m,l,k}$ is the post-MISO complex modulation value for carrier k of the OFDM symbol index l in Subframe index m for transmitter index x .

8.3 Inverse Fast Fourier Transform (IFFT)

The transmitted signal is organized into Frames, and each Frame further divided into a bootstrap, Preamble symbol(s) and Subframe(s). This section specifies the OFDM structure of the Preamble and Subframe symbols.

The Subframes in a Frame shall be numbered from 0 to m . Each Subframe m has a duration of T_{SFm} , and consists of L_{SFm} OFDM symbols.

The Preamble symbols in a Frame shall be numbered from 0 to $L_{FP}-1$.

The data and Subframe boundary symbols in OFDM Subframe m shall be numbered from 0 to $L_{SFm}-1$. All symbols shall contain both data and reference information (i.e. pilots).

Each symbol is constituted by a set of NoC carriers transmitted with a duration T_{Sm} . Each symbol is composed of two parts: a useful part with duration T_{Um} and a guard interval with duration T_{Gm} . The guard interval consists of a cyclic continuation of the useful part, T_{Um} , which shall be inserted before it. The allowed combinations of FFT size and guard interval are defined in Table 8.9.

Since the OFDM signal comprises many separately-modulated carriers, each symbol can in turn be considered to be divided into cells, each corresponding to the modulation carried on one carrier during one symbol.

The carriers are indexed by $k \in [0; NoC - 1]$. The spacing between adjacent carriers is $1/T_U$ while the spacing between carriers 0 and $NoC-1$ is determined by $(NoC-1)/T_U$.

The baseband time domain signal after IFFT shall be described by the following expression:

$$\sum_{l=0}^{L_{Fp}-1} \frac{1}{\sqrt{P_{preamble,l}}} \sum_{k=0}^{NoC_{P,l}-1} c_{l,k} \times \psi_{l,k}(t) + \sum_{m=0}^{N_{SF}-1} \frac{1}{\sqrt{P_{data,m}}} \sum_{l=0}^{L_{SFm}-1} \sum_{k=0}^{NoC_m-1} c_{m,l,k} \times \psi_{m,l,k}(t)$$

where:

$$\psi_{l,k}(t) = \begin{cases} e^{j2\pi \frac{k}{T_{Up}}(t-T_{BS}-T_{Gp}-lT_{Sp})} & T_{BS} + lT_{Sp} \leq t < T_{BS} + (l+1)T_{Sp} \\ 0 & \text{otherwise} \end{cases},$$

$$\psi_{m,l,k}(t) = \begin{cases} e^{j2\pi \frac{k}{T_{Um}}(t-T_{BS}-T_P-T_{Gm}-lT_{Sm}-\sum T_{SFm})} & T_{BS} + T_P + \sum T_{SFm} + lT_{Sm} \leq t < T_{BS} + T_P + \sum T_{SFm} + (l+1)T_{Sm} \\ 0 & \text{otherwise} \end{cases}$$

and:

k denotes the carrier number;

l denotes the OFDM symbol number starting from 0 for the first Preamble symbol of a Frame and being reset at the first OFDM symbol of each Subframe;

m denotes the Subframe number, $0 \leq m < N_{SF}$;

k' is the carrier index relative to the center frequency, $k' = k - (NoC - 1) / 2$;

$c_{l,k}$ is the complex modulation value for carrier k of the Preamble symbol number l ;

$c_{m,l,k}$ is the complex modulation value for carrier k of the OFDM symbol number l in Subframe number m ;

$NoC_{P,l}$ denotes the number of carriers in the $(l+1)^{th}$ Preamble symbol. The first Preamble symbol ($l=0$) always has the minimum NoC and the following Preamble symbols ($0 < l < L_{Fp}$) share the same NoC value that is signaled in L1-Basic as explained in Sections 7.2.5.1 and 9.2.2;

NoC_m denotes the number of carriers of Subframe m as defined in Table 8.8;

- L_{SFm} is the number of data and Subframe boundary symbols in Subframe m ;
- L_{Fp} is the number of OFDM symbols in the Preamble;
- T_{Sm} is the total symbol duration of each data and Subframe boundary symbol in Subframe m , and $T_{Sm} = T_{Um} + T_{Gm}$;
- T_{Um} is the useful symbol duration for each data and Subframe boundary symbol in Subframe m , defined in Table 8.8;
- T_{Gm} is the duration of the guard interval for each data and Subframe boundary symbol in Subframe m including extra samples for each data and Subframe boundary symbol as defined in Section 8.5;
- T_{BS} is the duration of the bootstrap;
- T_P is the total duration of the Preamble, where $T_P = L_{Fp} T_{Sp}$;
- T_{Sp} is the total symbol duration of each Preamble symbol and $T_{Sp} = T_{Up} + T_{Gp}$;
- T_{Up} is the useful symbol duration for each Preamble symbol;
- T_{Gp} is the duration of the guard interval for each Preamble symbol;
- T_{SFm} is the total duration of all data and Subframe boundary symbols in Subframe m ;
- $\sum T_{SFm}$ is the summation of the total duration of Subframes from 0 to $m-1$, $\sum T_{SFm} = \sum_{0}^{m-1} T_{SFm}$, $\sum T_{SFm} = 0$ if $m = 0$;
- N_{SF} is the number of Subframes in a Frame;
- $P_{\text{Preamble},l}$ is the frequency domain total power of the $(l + 1)^{\text{th}}$ Preamble symbol;
- $P_{\text{data},m}$ is the frequency domain total power of each data and Subframe boundary symbol in Subframe m .

The IFFT power normalization factor shall be used to normalize the average power of the baseband time domain signal to one regardless of the waveform parameters in use. Because the OFDM symbol power before power normalization varies significantly depending on the waveform parameters such as FFT size, scattered pilot pattern, amplitude of the scattered pilots, and the number of carriers, different IFFT power normalization factors shall be used for different settings of waveform parameters. The IFFT power normalization factor for the Preamble, $1/\sqrt{P_{\text{preamble},l}}$, can be obtained using the frequency domain total power of the Preamble symbol which is summarized in Table I.1.1. The IFFT power normalization factor for data and Subframe boundary symbols, $1/\sqrt{P_{\text{data},m}}$, can be obtained in a similar way using the frequency domain total power of the data and Subframe boundary symbol which is summarized in Table I.2.1 to Table I.2.5.

The OFDM parameters are summarized in Table 8.8. The values for the various time-related parameters are given in multiples of the elementary period T and in microseconds. The elementary period T is specified by $1/(0.384\text{MHz} \times (16 + \text{bsr_coefficient}))$, where **bsr_coefficient** is defined in Table 9.1 for each bandwidth, and approximate values for T are shown in Table 8.7 for convenience. The bandwidth of the system is determined from the value of **system_bandwidth** signaled in bootstrap symbol 1. See Section 9.1 for details of the bootstrap.

Table 8.7 Approximate Elementary Periods T

bsr_coefficient	2	5	8
Elementary period T (μs)	0.1447	0.1240	0.1085

Table 8.8 OFDM Parameters

Parameter		8K FFT	16K FFT	32K FFT
Number of carriers NoC	Cred_coeff = 0	6913	13825	27649
	Cred_coeff = 1	6817	13633	27265
	Cred_coeff = 2	6721	13441	26881
	Cred_coeff = 3	6625	13249	26497
	Cred_coeff = 4	6529	13057	26113
Duration T_U		8192 T	16384 T	32768 T
Duration T_U (μs) (see note 1 and 2)		<i>1185.185</i>	<i>2370.370</i>	<i>4740.741</i>
Carrier spacing $1/T_U$ (Hz) (see note 2)		843.75	421.875	210.9375
Spacing between carriers 0 and NoC – 1 (NoC-1)/T_U (MHz) (see note 2)	Cred_coeff = 0	5.832	5.832	5.832
	Cred_coeff = 1	5.751	5.751	5.751
	Cred_coeff = 2	5.670	5.670	5.670
	Cred_coeff = 3	5.589	5.589	5.589
	Cred_coeff = 4	5.508	5.508	5.508
Note 1: Numerical values in italics are approximate values.				
Note 2: Values are for bsr_coefficient =2 and system_bandwidth =6 MHz.				

8.4 Peak to Average Power Ratio Reduction Techniques

In order to reduce the Peak to Average Power Ratio of the output OFDM signal, modifications to the transmitted OFDM signal—tone reservation described in Section 8.4.1 and Active Constellation Extension (ACE) described in Section 8.4.2—may be used. None, one or both techniques may be used. Guard interval insertion is applied after the PAPR reduction.

8.4.1 Tone Reservation

When Tone Reservation (TR) is enabled, some OFDM carriers shall be reserved to allow the insertion of cells designed to reduce the overall PAPR of the output waveform. These cells shall not contain any payload data or signaling information.

The sets of carriers reserved for PAPR reduction in Preamble, data and Subframe boundary symbols shall be as defined in Table G.1.2 and Table G.1.3.

Depending on the data OFDM symbol index, the carriers in the tables specified above or the circular shifts of these values are used. The amount of circular shift depends on the pilot spacing D_X and D_Y . In a data symbol corresponding to an index l , the reserved carrier set S_l shall be calculated as:

$$S_l = i_k + D_X \times (l \bmod D_Y), i_n \in S_0, 0 \leq n < N_{TR}, d_0 \leq l \leq d_{end}$$

where S_0 represents the set of reserved carriers corresponding to carrier indices defined in the tables specified above, N_{TR} is the number of reserved cells per OFDM symbol, d_0 represents the index of the first OFDM symbol of the Subframe and d_{end} represents the index of the last data symbol.

An example algorithm for generating the values inserted into the tone reservation carriers is described in Annex M.2.

8.4.2 Active Constellation Extension (ACE)

The Active Constellation Extension (ACE) algorithm reduces the PAPR by the modification of the transmitted constellation points. The active constellation extension technique shall not be applied to pilot carriers or reserved tones. ACE shall not be used in conjunction with LDM, MISO or MIMO.

An example algorithm for ACE is described in Annex M.3.

8.5 Guard Interval

In Table 8.9 twelve guard intervals are defined in terms of the absolute guard interval length expressed in samples. Table 8.9 additionally defines with a check mark ✓ which guard interval patterns shall be allowed for each FFT size, those guard interval patterns not allowed are shown by *N/A*.

Table 8.9 Duration of the Guard Intervals in Samples

GI Pattern	Duration in Samples	8K FFT	16K FFT	32K FFT
GI1_192	192	✓	✓	✓
GI2_384	384	✓	✓	✓
GI3_512	512	✓	✓	✓
GI4_768	768	✓	✓	✓
GI5_1024	1024	✓	✓	✓
GI6_1536	1536	✓	✓	✓
GI7_2048	2048	✓	✓	✓
GI8_2432	2432	<i>N/A</i>	✓	✓
GI9_3072	3072	<i>N/A</i>	✓	✓
GI10_3648	3648	<i>N/A</i>	✓	✓
GI11_4096	4096	<i>N/A</i>	✓	✓
GI12_4864	4864	<i>N/A</i>	<i>N/A</i>	✓

8.5.1 Guard Interval Extension for Time-aligned Frames

The contents of this section shall apply when time-aligned Frames are indicated. The contents of this section shall not apply when symbol-aligned Frames are indicated.

When a time-aligned Frame is indicated, zero or more extra samples in addition to the indicated guard interval (see Table 8.9) shall be inserted to make the total actual Frame length equal to the signaled Frame length. These extra samples shall be distributed to the specific portions of the non-Preamble OFDM symbols within the Frame using the following algorithm. The approach detailed here ensures that all OFDM symbols within a given Subframe have the same guard interval length and that an equal number of extra samples are distributed to the guard interval of every non-Preamble OFDM symbol within a Frame.

- $T_{bootstrap}$ is the total time length (in seconds) of the bootstrap for the current Frame.
- T_{frame} is the indicated total Frame time length in seconds.
- BSR is the baseband sampling rate (in MSamples/s) for the non-bootstrap portion of the current Frame.
- $N_{symbols}^{preamble}$ is the number of Preamble symbols.
- $N_{FFT}^{preamble}$ is the FFT size of the Preamble symbols.

- $N_{GI}^{preamble}$ is the guard interval length (in samples) for the Preamble symbols.
- N_{sub} is the total number of Subframes in the Frame.
- $N_{symbols}^k$ is the number of OFDM symbols (including any Subframe boundary symbols) in the k th Subframe.
- N_{FFT}^k is the FFT size for the k th Subframe.
- N_{GI}^k is the indicated guard interval length (in samples) for the k th Subframe.
- N_{extra} is the total number of extra samples required to be inserted into a Frame in order to make the actual and signaled Frame lengths equal. N_{extra} shall be calculated as:

$$N_{extra} = (T_{frame} - T_{bootstrap}) \times BSR - N_{symbols}^{preamble} \times (N_{FFT}^{preamble} + N_{GI}^{preamble}) - \sum_{k=1}^{N_{sub}} N_{symbols}^k \times (N_{FFT}^k + N_{GI}^k)$$

- $N_{symbols} = \sum_{k=1}^{N_{sub}} N_{symbols}^k$ is the total number of non-Preamble OFDM symbols contained in the Frame (across all N_{sub} Subframes).
- The guard interval of each non-Preamble OFDM symbol in the Frame shall receive $\text{floor}(N_{extra}/N_{symbols})$ extra samples as illustrated in Figure 8.4, where $\text{floor}(x)$ is defined as the largest integer that is less than or equal to x .

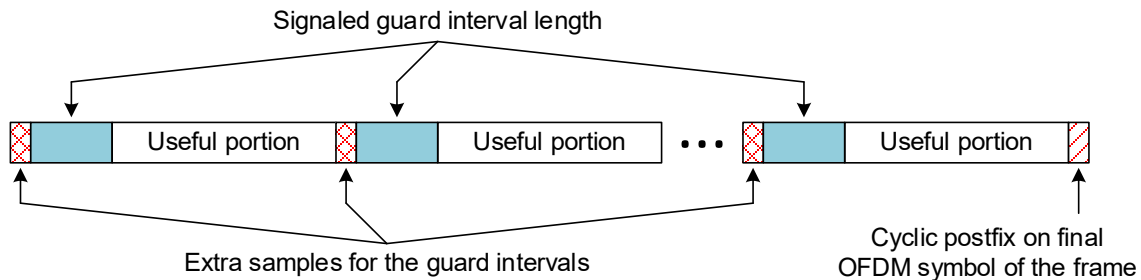

Figure 8.4 Illustration of the assignment of extra samples to the guard interval of each non-Preamble OFDM symbol in a Frame.

- The remaining leftover $N_{extra} \bmod N_{symbols}$ extra samples, if any, shall be inserted immediately following the final OFDM symbol of the final Subframe of the Frame. These samples shall represent a cyclic postfix of that OFDM symbol consisting of the requisite number of samples copied from the beginning of the useful portion of that OFDM symbol, as illustrated in Figure 8.5.

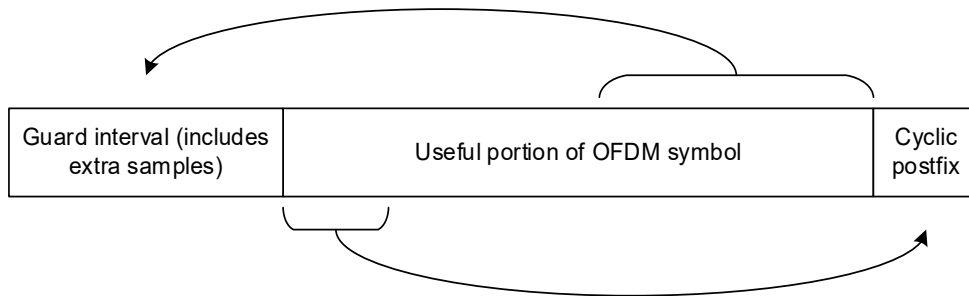

Figure 8.5 Illustration of remaining leftover extra samples being assigned to a cyclic postfix of the final OFDM symbol of the final Subframe of the Frame.

8.6 Bootstrap

The bootstrap symbol construction is defined in detail in [2]. Section 9.1 establishes constraints on the payload contents of the bootstrap to represent the set of capabilities that this standard supports.

When MIMO or Layered MIMO is applied, the bootstrap symbols prefixed to a frame shall be identical between the Polarizations, while the amplitudes may differ. In each Polarization, amplitude of the bootstrap symbol should conform to that of the following Preamble symbol.

9. L1 SIGNALING

L1 signaling provides the necessary information to configure the physical layer parameters. The term ‘L1’ refers to Layer-1, the lowest layer of the ISO 7-layer model. L1 signaling consists of three parts: constraints on the bootstrap, described in Section 9.1, L1-Basic which is described in Section 9.2 and L1-Detail which is described in Section 9.3. Both L1-Basic and L1-Detail are carried in the Preamble symbols.

L1-Basic conveys the most fundamental signaling information of the system and also defines the parameters needed to decode L1-Detail. The length of L1-Basic signaling is fixed at 200 bits.

L1-Detail details the data context and the required information to decode it. The length of L1-Detail signaling may vary from Frame to Frame.

Note: Some signaling fields represent quantities for which the actual value zero is not valid (e.g., zero Preamble symbols is not a valid configuration). Therefore, signaling of a value one less than the actual value is used in these cases to maximize the efficiency of the range of values that can be signaled by the number of signaling bits available for each signaling field.

9.1 Bootstrap

This section establishes constraints on the payload contents of the bootstrap symbols to represent the set of capabilities that this standard supports. Versioning is defined in Section 9.1.1, and the bootstrap symbol contents are defined in Sections 9.1.2, 9.1.3 and 9.1.4 respectively. Any contents not explicitly defined here shall follow [2].

9.1.1 Versioning

The value of **bootstrap_major_version** as defined by [2] shall be 0.

The value of **bootstrap_minor_version** as defined by [2] shall be 0.

9.1.2 Bootstrap Symbol 1

The constraints and meanings for the contents of bootstrap symbol 1 are completely defined by [2].

9.1.3 Bootstrap Symbol 2

The value for the **bsr_coefficient** defined in [2] (part of bootstrap symbol 2) shall be one of the values shown in Table 9.1, and shall be the one that is applicable to the bandwidth of the emission.

Table 9.1 Defined Values of **bsr_coefficient**

bsr_coefficient	Applicability
2	6 MHz bandwidth
5	7 MHz bandwidth
8	8 MHz bandwidth

9.1.4 Bootstrap Symbol 3

The value for the **preamble_structure** defined in [2] (bootstrap symbol 3) shall be one of the non-reserved values listed in Table H.1.1.

9.2 Syntax for L1-Basic Data

The syntax and field semantics of the L1-Basic signaling fields shall be as defined in Table 9.2 and the following subsections. The names of signaling fields in L1-Basic are always prefixed with ‘L1B_’.

Table 9.2 L1-Basic Signaling Fields and Syntax

Syntax	No. of Bits	Format
L1_Basic_signaling() {		
L1B_version	3	uimsbf
L1B_mimo_scattered_pilot_encoding	1	uimsbf
L1B_lls_flag	1	uimsbf
L1B_time_info_flag	2	uimsbf
L1B_return_channel_flag	1	uimsbf
L1B_papr_reduction	2	uimsbf
L1B_frame_length_mode	1	uimsbf
if (L1B_frame_length_mode =0) {		
L1B_frame_length	10	uimsbf
L1B_excess_samples_per_symbol	13	uimsbf
} else {		
L1B_time_offset	16	uimsbf
L1B_additional_samples	7	uimsbf
}		
L1B_num_subframes	8	uimsbf
L1B_preamble_num_symbols	3	uimsbf
L1B_preamble_reduced_carriers	3	uimsbf
L1B_L1_Detail_content_tag	2	uimsbf
L1B_L1_Detail_size_bytes	13	uimsbf
L1B_L1_Detail_fec_type	3	uimsbf
L1B_L1_Detail_additional_parity_mode	2	uimsbf
L1B_L1_Detail_total_cells	19	uimsbf
L1B_first_sub_mimo	1	uimsbf
L1B_first_sub_miso	2	uimsbf
L1B_first_sub_fft_size	2	uimsbf

L1B_first_sub_reduced_carriers	3	uimsbf
L1B_first_sub_guard_interval	4	uimsbf
L1B_first_sub_num_ofdm_symbols	11	uimsbf
L1B_first_sub_scattered_pilot_pattern	5	uimsbf
L1B_first_sub_scattered_pilot_boost	3	uimsbf
L1B_first_sub_sbs_first	1	uimsbf
L1B_first_sub_sbs_last	1	uimsbf
L1B_first_sub_mimo_mixed	1	uimsbf
L1B_reserved	47	uimsbf
L1B_crc	32	uimsbf
}		

9.2.1 L1-Basic System and Frame Parameters

The following parameters provide information related to the entire Frame.

L1B_version – This field shall indicate the version of the L1-Basic signaling structure that is used for the current Frame. For the current version of the specification **L1B_version** shall be set to 1. It is envisaged that when new L1-Basic signaling fields are introduced into an updated L1-Basic signaling structure in such a manner that the presence or absence of at least one of those new L1-Basic signaling fields cannot be otherwise deduced, **L1B_version** would be incremented by 1. New L1-Basic signaling fields that are introduced into an L1-Basic signaling structure corresponding to a particular **L1B_version** should be added in such a manner that they do not interfere with the parsing of L1-Basic signaling fields by receivers that have been provisioned only up to an earlier **L1B_version**.

L1B_mimo_scattered_pilot_encoding – This field shall indicate the appropriate MIMO pilot encoding scheme used by any MIMO Subframes in the current Frame as given in Table 9.3. When there are no MIMO Subframes in the current Frame, the value of **L1B_mimo_scattered_pilot_encoding** shall be signaled as 0.

Table 9.3 Signaling Format for **L1B_mimo_scattered_pilot_encoding**

Value	Meaning
0	Walsh-Hadamard pilots or no MIMO Subframes
1	Null pilots

L1B_lls_flag – This field shall indicate the presence or absence of Low Level Signaling (LLS) in one or more PLPs in the current Frame. **L1B_lls_flag**=0 shall indicate there is no LLS signaling in the current Frame, while **L1B_lls_flag**=1 shall indicate there is LLS signaling carried in this Frame. The PLP(s) which carry LLS shall be indicated by **L1D_plp_lls_flag**.

L1B_time_info_flag – This field shall indicate the presence or absence of timing information in the current Frame, and the precision to which it is signaled according to Table 9.4.

Table 9.4 Signaling Format for **L1B_time_info_flag**

Value	Meaning
00	Time information is not included in the current Frame
01	Time information is included in the current Frame and signaled to ms precision
10	Time information is included in the current Frame and signaled to μ s precision
11	Time information is included in the current Frame and signaled to ns precision

L1B_return_channel_flag – This field shall indicate whether a dedicated return channel (DRC) is present. Specifically, **L1B_return_channel_flag** = 1 shall indicate that DRC is supported in the current Frame of the current frequency band and current broadcast network. **L1B_return_channel_flag** = 0 shall indicate that DRC is not supported in the current Frame of the current frequency band and current broadcast network.

L1B_papr_reduction – This field shall indicate the technique to reduce the peak to average power ratio within the current Frame as given in Table 9.5. The PAPR reduction technique shall apply to all OFDM symbols contained within the current Frame, with the exception of the first Preamble symbol. **L1B_papr_reduction**=10 and **L1B_papr_reduction**=11 shall not be indicated when any of the following conditions is satisfied.

- **L1B_first_sub_miso**=01 or **L1B_first_sub_miso**=10 and/or **L1D_miso**=01 or **L1D_miso**=10 for any Subframe within the current Frame.
- **L1B_first_sub_mimo**=1 and/or **L1D_mimo**=1 for any Subframe within the current Frame.
- **L1D_plp_layer**>0 for any PLP within the current Frame.

Table 9.5 Signaling Format for **L1B_papr_reduction**

Value	Meaning
00	No PAPR reduction used
01	tone reservation only
10	ACE only
11	Both TR and ACE

L1B_frame_length_mode – This field shall be set to **L1B_frame_length_mode**=0 to indicate that the current Frame is time-aligned with excess sample distribution to the guard intervals of Data Payload OFDM symbols (i.e. non-Preamble OFDM symbols) as described in Section 8.5.1. The field shall be set to **L1B_frame_length_mode**=1 to indicate that the current Frame is symbol-aligned with no excess sample distribution.

L1B_frame_length – This field shall only be included when **L1B_frame_length_mode**=0 (i.e. when time-aligned Frames are configured) and shall indicate the time period measured from the beginning of the first sample of the bootstrap associated with the current Frame to the end of the final sample associated with the current Frame (i.e. the signaled Frame length also includes the length of the bootstrap). The time period indicated shall be expressed in units of 5 ms (i.e. time period = **L1B_frame_length** × 5 ms). As stated in Section 7.2.2.2, the minimum Frame length is 50 ms and the maximum Frame length is 5 seconds, which implies that $10 \leq \mathbf{L1B_frame_length} \leq 1000$.

L1B_excess_samples_per_symbol – This field shall only be included when **L1B_frame_length_mode**=0 (i.e. when time-aligned Frames are configured) and shall indicate the additional number of excess samples included in the guard interval of each non-Preamble OFDM symbol of the post-bootstrap portion of the current Frame when time-aligned Frames are used. The same number of excess samples is included in the guard interval of each and every non-Preamble OFDM symbol of the post-bootstrap portion of a Frame according to the excess sample insertion algorithm described in Section 8.5.1. The total length of the guard interval for each OFDM symbol belonging to a particular Subframe of the current Frame shall be equal to the sum of the guard interval length for that particular Subframe (as indicated by **L1B_first_sub_guard_interval** for the first Subframe and by the appropriate **L1D_guard_interval** for any subsequent Subframes) and the value signaled by **L1B_excess_samples_per_symbol**.

L1B_time_offset – This field shall only be included when **L1B_frame_length_mode**=1 (i.e. when symbol-aligned Frames are configured) and shall indicate the number of sample periods (using the BSR configured for the current Frame) between the nearest preceding or coincident millisecond boundary and the leading edge of the Frame.

L1B_additional_samples – This field shall only be included when **L1B_frame_length_mode**=1 (i.e. when symbol-aligned Frames are configured) and shall indicate the number of additional samples added at the end of a Frame to facilitate sampling clock alignment. For the current version of the specification, **L1B_additional_samples** shall be set to 0 when present.

L1B_num_subframes – This field shall be set to 1 less than the number of Subframes present within the current Frame. That is, **L1B_num_subframes**=0 shall indicate that 1 Subframe is present within the current Frame, **L1B_num_subframes**=1 shall indicate that two Subframes are present within the current Frame, and so on.

9.2.2 L1-Basic Parameters for L1-Detail

The following parameters provide information required to decode the remainder of the Preamble, that is, L1-Detail.

L1B_preamble_num_symbols – This field shall be set to one less than the total number of Preamble OFDM symbols. Example: When there is just one Preamble symbol, **L1B_preamble_num_symbols** would be set equal to 0.

L1B_preamble_reduced_carriers – This field shall indicate the number of control units of carriers by which the maximum number of carriers for the FFT size used for the Preamble is reduced. This carrier reduction shall apply to all of the Preamble symbols of the current Frame with the exception of the first Preamble symbol. See Section 7.2.6.3 for details. When there is only one Preamble symbol, the value of this field shall be zero.

L1B_L1_Detail_content_tag – This field shall be incremented by 1 whenever the L1-Detail contents of the current Frame have been modified as compared to the L1-Detail contents of the previous Frame with a bootstrap of the same major and minor version as the current Frame. The following signaling fields are excluded from determination of when to increment **L1B_L1_Detail_content_tag**: **L1D_time_sec**, **L1D_time_msec**, **L1D_time_usec**, **L1D_time_nsec** (including the presence or absence of any of these listed time fields) **L1D_plp_lls_flag**, **L1D_plp_fec_block_start**, **L1D_plp_CTI_fec_block_start**, and **L1D_plp_CTI_start_row**. The initial value of **L1B_L1_Detail_content_tag** shall be 0. When **L1B_L1_Detail_content_tag** is incremented after reaching the maximum value, it shall wrap, and the next transmitted value shall be 0.

L1B_L1_Detail_size_bytes – This field shall indicate the size (in bytes) of the L1-Detail information. The indicated number of L1-Detail information bytes shall not include any additional parity bits that are included in the current Frame for the next Frame's L1-Detail. The minimum value of this field shall be 25 bytes.

L1B_L1_Detail_fec_type – This field shall indicate the FEC type for L1-Detail information protection as given in Table 9.6. The details of the FEC type are described in Section 6.5.2.1.

Table 9.6 Signaling Format for **L1B_L1_Detail_fec_type**

Value	FEC Type
000	Mode 1
001	Mode 2
010	Mode 3
011	Mode 4
100	Mode 5
101	Mode 6
110	Mode 7
111	Reserved

L1B_L1_Detail_additional_parity_mode – This field shall indicate the Additional Parity Mode (defined in Section 6.5.3.2) which gives the ratio (K) of the number of additional parity bits for the next Frame’s L1-Detail that are carried in the current Frame to half of the number of coded bits for the next Frame’s L1-Detail signaling. (Here, the next Frame shall be considered to be the next Frame whose bootstrap has the same major and minor version as the current Frame.) The value of the field shall be given as shown in Table 9.7.

Table 9.7 Signaling Format for **L1B_additional_parity_mode**

Value	Additional Parity Mode
00	$K = 0$ (No additional parity used)
01	$K = 1$
10	$K = 2$
11	Reserved for future use

L1B_L1_Detail_total_cells – This field shall indicate the total size (specified in OFDM cells) of the combined coded and modulated L1-Detail signaling for the current Frame and the modulated additional parity bits for L1-Detail signaling of the next Frame.

9.2.3 L1-Basic Parameters for First Subframe

The parameters of the first Subframe of the current Frame are signaled within L1-Basic to facilitate the immediate initial OFDM processing of this first Subframe at a receiver without needing to wait until L1-Detail is decoded.

L1B_first_sub_mimo – This field shall indicate whether MIMO (see Annex L and Annex O) is used for all PLPs in the first subframe of the current frame. A value of 1 shall indicate that MIMO processing is applied to all PLPs in the first subframe. A value of 0 shall indicate that the first subframe includes one or more PLPs to which MIMO processing is not applied. See Table 9.8 and note that the setting of this field to 1 is mutually exclusive with the setting of **L1B_first_sub_mimo_mixed** to 1, as shown on the last line of the table.

L1B_first_sub_mimo_mixed – This field shall indicate whether the first subframe of the current frame multiplexes PLPs using MIMO with other PLPs not using MIMO. A value of 1 shall indicate that PLPs using and not using MIMO are multiplexed within the subframe, and a value of 0 shall indicate that all PLPs in the subframe either use MIMO (i.e., **L1B_first_sub_mimo** =1) or do not use MIMO (i.e., **L1B_first_sub_mimo** =0).

When LDM is applied to the first subframe in a frame (i.e., when PLPs having **L1D_plp_layer values** >0 are present in the subframe), the values of **L1B_first_sub_mimo_mixed** indicate the

following: When set to 1, MIMO processing shall be applied to all Enhanced PLPs (i.e., **L1D_plp_layer** >0) in the described subframe, and MIMO processing shall not be applied to all Core PLPs (i.e., **L1D_plp_layer** =0) in the described subframe. See Table 9.8, and note that the setting of this field to 1 is mutually exclusive with the setting of **L1D_first_sub_mimo** to 1, as shown on the last line of the table.

Table 9.8 Use Cases and Indications Related to MIMO: Signaling Format for **L1B_first_sub_mimo_mixed** in Conjunction with **L1B_first_sub_mimo**

MIMO Configurations	Related L1-Basic Signaling Assignment	
	L1B_first_sub_mimo	L1B_first_sub_mimo_mixed
All PLPs in first subframe use SISO	0	0
PLPs of both types in first subframe	0	1
All PLPs in first subframe use MIMO	1	0
Invalid Combination	1	1

Note: In cases of all-SISO and all-MIMO PLPs within the first subframe, any of the available multiplexing types (i.e., TDM, FDM, LDM, and combinations thereof) can be applied. In cases in which MIMO is to be applied differently to the PLPs on the respective layers (i.e., Core and Enhanced) within a subframe, LDM multiplexing is required to be applied to the subframe (potentially along with TDM, FDM, and combinations thereof on either or both of the layers).

L1B_first_sub_miso – This field shall indicate the MISO (see Section 8.2) option used for the first Subframe of the current Frame as given in Table 9.11.

L1B_first_sub_fft_size – This field shall indicate the FFT size associated with the first Subframe of the current Frame as given in Table 9.12. Note that the FFT size of a Frame's Preamble and the FFT size of the same Frame's first Subframe are the same, as specified in Section 7.2.2.1.

L1B_first_sub_reduced_carriers – This field shall indicate the number of control units of carriers by which the maximum number of carriers for the FFT size used for the first Subframe of the current Frame is reduced. This carrier reduction shall apply to all of the symbols of the first Subframe of the current Frame (see Section 7.2.3 for details).

L1B_first_sub_guard_interval – This field shall indicate the guard interval length used for the OFDM symbols of the first Subframe of the current Frame as given in Table 9.13. Guard interval lengths (e.g. 192 samples for GI1_192) shall be as defined in Table 8.9. Note that the signaled guard interval length for the first Subframe of a Frame is the same as the guard interval length indicated for that same Frame's Preamble, as specified in Section 7.2.2.1.

L1B_first_sub_num_ofdm_symbols – This field shall be set equal to one less than the total number of data payload OFDM symbols, including any Subframe boundary symbol(s), present within the first Subframe of the current Frame. The number of data payload OFDM symbols in a Subframe is greater than or equal to $4 \times D_Y$ where D_Y is taken from the scattered pilot pattern that is configured for the Subframe (see Section 7.2.4.2). OFDM symbols containing Preamble signaling shall not be included within this count, although OFDM symbols containing Preamble signaling may also carry portions of PLPs associated with the first Subframe of a Frame if data cells are available on those OFDM symbols.

L1B_first_sub_scattered_pilot_pattern – This field shall indicate the scattered pilot pattern used for the first Subframe of the current Frame as given in Table 9.14 for SISO, and as given in Table 9.15 for MIMO. SP pattern values (e.g. SP3_2, MIMO3_2) shall be as defined in Table 8.2 (SISO) and Table L.9.2 (MIMO).

L1B_first_sub_scattered_pilot_boost – The value of this field combined with the scattered pilot pattern shall represent the power of the scattered pilots (in dB) used for the first Subframe of the current Frame. The exact power values (used to calculate the amplitude) shall be as defined in Table 9.16. Equivalent but approximate amplitudes (after conversion from dB to linear) of the scattered pilots are listed in Table 9.17. The values of 101, 110 and 111 shall be reserved for future use.

L1B_first_sub_sbs_first – This field shall indicate whether or not the first symbol of the first Subframe of the current Frame is a Subframe boundary symbol. **L1B_first_sub_sbs_first**=0 shall indicate that the first symbol of the first Subframe of the current Frame is not a Subframe boundary symbol. **L1B_first_sub_sbs_first** =1 shall indicate that the first symbol of the first Subframe of the current Frame is a Subframe boundary symbol.

L1B_first_sub_sbs_last – This field shall indicate whether or not the last symbol of the first Subframe of the current Frame is a Subframe boundary symbol. **L1B_first_sub_sbs_last** =0 shall indicate that the last symbol of the first Subframe of the current Frame is not a Subframe boundary symbol. **L1B_first_sub_sbs_last** =1 shall indicate that the last symbol of the first Subframe of the current Frame is a Subframe boundary symbol.

9.2.4 L1-Basic Miscellaneous Parameters

The remaining miscellaneous parameters in L1-Basic are as follows.

L1B_reserved – This field shall contain reserved bits as required to pad L1-Basic out to the total length. It is envisaged that any new signaling fields defined for a newer version of the L1-Basic signaling structure would occupy a portion of these reserved bits to maintain backward-compatibility for legacy receivers. Receivers are expected to ignore the contents of **L1B_reserved**.

L1B_crc – This field shall contain the CRC value as computed according to Section 6.1.2.2 over the contents of L1-Basic excluding the **L1B_crc** field.

9.3 Syntax and Semantics for L1-Detail Data

The syntax and field semantics of the L1-Detail signaling fields shall be as defined in Table 9.9 and the following subsections. The names of signaling fields in L1-Detail are always prefixed with ‘**L1D_**’.

In Table 9.9, there are a nested pair of ‘for’ loops, having outer and inner loops denoted as ‘i’ and ‘j’, which process the Subframes within a physical layer Frame and the PLPs within each Subframe, respectively. This nested pair of ‘for’ loops appears twice in the table. The ordering of the Subframes and the PLPs within each Subframe is given in full in the first appearances of the ‘i’ and ‘j’ ‘for’ loops in Table 9.9, and the same ordering of the Subframes and the PLPs within them shall be applied in the second appearances of those loops in the table.²

2 The splitting of the ‘i’ and ‘j’ ‘for’ loops into two sections each was necessitated by the evolution of functions described in the table to enable simultaneous use of multiple signal processing methods while maintaining backward compatibility. The first section ‘for’ loop is called the ‘**L1D_version** >= 1 loop’ and the second section ‘for’ loop is called the ‘**L1D_version** >= 2 loop’.

Table 9.9 L1-Detail Signaling Fields and Syntax

Syntax	No. of Bits	Format
L1_Detail_signaling() {		
L1D_version	4	uimsbf
L1D_num_rf	3	uimsbf
for (L1D_rf_id=1 .. L1D_num_rf) {		
L1D_bonded_bsid	16	uimsbf
reserved	3	bslbf
}		
if (L1B_time_info_flag != 00) {		
L1D_time_sec	32	uimsbf
L1D_time_msec	10	uimsbf
if (L1B_time_info_flag != 01) {		
L1D_time_usec	10	uimsbf
if (L1B_time_info_flag != 10) {		
L1D_time_nsec	10	uimsbf
}		
}		
}		
for (i=0 .. L1B_num_subframes) {		
if (i > 0) {		
L1D_mimo	1	uimsbf
L1D_miso	2	uimsbf
L1D_fft_size	2	uimsbf
L1D_reduced_carriers	3	uimsbf
L1D_guard_interval	4	uimsbf
L1D_num_ofdm_symbols	11	uimsbf
L1D_scattered_pilot_pattern	5	uimsbf
L1D_scattered_pilot_boost	3	uimsbf
L1D_sbs_first	1	uimsbf
L1D_sbs_last	1	uimsbf
}		
if (L1B_num_subframes>0) {		
L1D_subframe_multiplex	1	uimsbf
}		
L1D_frequency_interleaver	1	uimsbf
if (((i=0)&&(L1B_first_sub_sbs_first L1B_first_sub_sbs_last))		
((i>0)&&(L1D_sbs_first L1D_sbs_last))) {		
L1D_sbs_null_cells	13	uimsbf
}		
L1D_num_plp	6	uimsbf
for (j=0 .. L1D_num_plp) {		
L1D_plp_id	6	uimsbf
L1D_plp_ils_flag	1	uimsbf
L1D_plp_layer	2	uimsbf
L1D_plp_start	24	uimsbf
}		

L1D_plp_size	24	uimsbf
L1D_plp_scrambler_type	2	uimsbf
L1D_plp_fec_type	4	uimsbf
if (L1D_plp_fec_type∈{0,1,2,3,4,5}) {		
L1D_plp_mod	4	uimsbf
L1D_plp_cod	4	uimsbf
}		
L1D_plp_TI_mode	2	uimsbf
if (L1D_plp_TI_mode=00) {		
L1D_plp_fec_block_start	15	uimsbf
} else if (L1D_plp_TI_mode=01) {		
L1D_plp_CTI_fec_block_start	22	uimsbf
}		
if (L1D_num_rf>0) {		
L1D_plp_num_channel_bonded	3	uimsbf
if (L1D_plp_num_channel_bonded>0) {		
L1D_plp_channel_bonding_format	2	uimsbf
for (k=0..L1D_plp_num_channel_bonded){		
L1D_plp_bonded_rf_id	3	uimsbf
}		
}		
}		
if (i=0 && L1B_first_sub_mimo=1) (i >0 && L1D_mimo=1) {		
L1D_plp_mimo_stream_combining	1	uimsbf
L1D_plp_mimo_IQ_interleaving	1	uimsbf
L1D_plp_mimo_PH	1	uimsbf
}		
if (L1D_plp_layer=0) {		
L1D_plp_type	1	uimsbf
if (L1D_plp_type=1) {		
L1D_plp_num_subslices	14	uimsbf
L1D_plp_subslice_interval	24	uimsbf
}		
if (((L1D_plp_TI_mode=01)		
(L1D_plp_TI_mode=10))&&(L1D_plp_mod=0000)) {		
L1D_plp_TI_extended_interleaving	1	uimsbf
}		
if (L1D_plp_TI_mode=01) {		
L1D_plp_CTI_depth	3	uimsbf
L1D_plp_CTI_start_row	11	uimsbf
} else if (L1D_plp_TI_mode=10) {		
L1D_plp_HTI_inter_subframe	1	uimsbf
L1D_plp_HTI_num_ti_blocks	4	uimsbf
L1D_plp_HTI_num_fec_blocks_max	12	uimsbf
if (L1D_plp_HTI_inter_subframe=0) {		
L1D_plp_HTI_num_fec_blocks	12	uimsbf
} else {		
for (k=0..L1D_plp_HTI_num_ti_blocks) {		

version of this standard would be able to parse the known portions of L1-Detail successfully without requiring knowledge of the structure or contents of any new fields added to what that parser would perceive as **L1D_reserved**.

L1D_time_sec – This field is the seconds portion of the precise TAI time³ at which the first sample of the first symbol of the most recent bootstrap was transmitted, shown as the Time Information Position in Figure 9.1. **L1D_time_sec** shall contain the 32 least significant bits of the number of seconds elapsed between the PTP epoch (see IEEE 1588 [5], Section 7.2.2) and the precise time at which the first sample of the first symbol of the most recent bootstrap was transmitted. The time value shall be transmitted at least once in every 5 second interval.

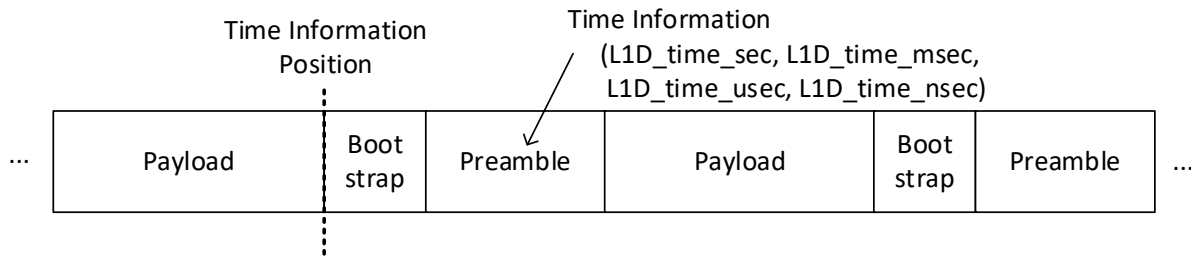

Figure 9.1 Illustration of the Time Information Position and the time information being transmitted in the Preamble.

L1D_time_msec – This field shall indicate the milliseconds component of the time information specified under **L1D_time_sec**. For example, if the portion of the time information less than one second is 0.123456789 this field shall be 123.

L1D_time_usec – This field shall indicate the microseconds component of the time information specified under **L1D_time_sec**. For example, if the portion of the time information less than one second is 0.123456789 this field shall be 456.

L1D_time_nsec – This field shall indicate the nanoseconds component of the time information specified under **L1D_time_sec**. For example, if the portion of the time information less than one second is 0.123456789 this field shall be 789.

L1D_reserved – This field shall contain reserved bits as needed to pad L1-Detail out to the total bit length indicated by **L1B_L1_Detail_size_bytes**. It is expected that one primary use of **L1D_reserved** on the transmitter side will be to ensure byte alignment of the total length of L1-Detail by including from 0 to 7 padding bits as required. Future versions of the L1-Detail signaling structure may add new signaling fields, which would be seen as part of the **L1D_reserved** field by legacy receivers. Receivers are therefore expected not to make any assumptions about the expected contents and/or length of **L1D_reserved**.

L1D_crc – This field shall contain the CRC value as computed in Section 6.1.2.2 over the contents of L1-Detail excluding the **L1D_crc** field.

9.3.2 L1-Detail Channel Bonding Parameters (Frame)

The following L1-Detail signaling fields are related to channel bonding.

L1D_num_rf – This field shall indicate the number of frequencies involved in channel bonding, not including the frequency of the present channel. For the current version of the specification

³ A monotonically increasing seconds count, without adjustment for leap seconds, maintained by the International Bureau of Weights and Measures (BIPM).

L1D_num_rf shall have a maximum value of 1 (i.e. bonding of the current channel with one other channel). **L1D_num_rf=0** shall indicate that channel bonding is not used for the current Frame.

L1D_rf_id – This implicitly defined field shall specify the IDs of the other RF channels involved in channel bonding. The current RF channel shall be assigned an implicit **L1D_rf_id** of 0. The first RF channel in the list shall be assigned an implicit **L1D_rf_id** of 1, and so on. For the current version of the specification **L1D_rf_id**, if defined, shall have a maximum value of 1.

L1D_bonded_bsid – This field shall indicate the BSID of a separate RF channel that is channel bonded with the current RF channel, and that is associated with the implicit ID of **L1D_rf_id**. The BSID of the current channel is **L1D_bsid**.

L1D_bsid – This field shall indicate the BSID of the current channel. The value of **L1D_bsid** shall be unique on a regional level (for example, North America). An administrative or regulatory authority may play a role in assuring the uniqueness of this value. This field was defined starting with **L1D_version** = 1.

9.3.3 L1-Detail Subframe Parameters

L1-Detail parameters related to Subframe configuration are as follows.

L1D_mimo – This field shall indicate whether MIMO (see Annex L and Annex O) is used for all PLPs in the current Subframe. A value of 1 shall indicate that MIMO processing is applied to all PLPs in the current Subframe. A value of 0 shall indicate that the Subframe includes one or more PLPs to which MIMO processing is not applied. See Table 9.10, and note that the setting of this field to 1 is mutually exclusive with the setting of **L1D_mimo_mixed** to 1, as shown on the last line of the table.

L1D_mimo_mixed – This field shall indicate whether the current Subframe multiplexes PLPs using MIMO with other PLPs not using MIMO. A value of 1 shall indicate that PLPs using and not using MIMO are multiplexed within the Subframe, and a value of 0 shall indicate that all PLPs in the Subframe either use MIMO (i.e., **L1D_mimo** =1) or do not use MIMO (i.e., **L1D_mimo** =0).

When LDM is applied to a Subframe (i.e., when PLPs having **L1D_plp_layer** values >0 are present in the Subframe), the values of **L1D_mimo_mixed** indicate the following: When set to 1, MIMO processing shall be applied to all Enhanced PLPs (i.e., **L1D_plp_layer** >0) in the described Subframe, and MIMO processing shall not be applied to all Core PLPs (i.e., **L1D_plp_layer** =0) in the described Subframe. See Table 9.10, and note that the setting of this field to 1 is mutually exclusive with the setting of **L1D_mimo** to 1, as shown on the last line of the table.

Table 9.10 Use Cases and Indications Related to MIMO: Signaling Format for **L1D_mimo_mixed** in Conjunction with **L1D_mimo**

MIMO Configurations	Related L1-Detail Signaling Assignment	
	L1D_mimo	L1D_mimo_mixed
All PLPs in Subframe use SISO	0	0
PLPs of both types in Subframe	0	1
All PLPs in Subframe use MIMO	1	0
Invalid Combination	1	1

Note: In cases of all-SISO and all-MIMO PLPs within a Subframe, any of the available multiplexing types (i.e., TDM, FDM, LDM, and combinations thereof) can be applied. In cases in which MIMO is to be applied differently to the PLPs on the respective layers (i.e., Core and Enhanced) within a Subframe, LDM multiplexing is required to be applied to the Subframe (potentially along with TDM, FDM, and combinations thereof on either or both of the layers).

L1D_miso – This field shall indicate the MISO (see Section 8.2) option used for the current Subframe as given in Table 9.11.

Table 9.11 Signaling Format for **L1D_miso** and **L1B_first_sub_miso**

Value	MISO option
00	No MISO
01	MISO with 64 coefficients
10	MISO with 256 coefficients
11	Reserved

L1D_fft_size – This field shall indicate the FFT size associated with the current Subframe as given in Table 9.12.

Table 9.12 Signaling Format for **L1D_fft_size** and **L1B_first_sub_fft_size**

Value	FFT Size
00	8K
01	16K
10	32K
11	Reserved

L1D_reduced_carriers – This field shall indicate the number of control units of carriers by which the maximum number of carriers for the FFT size used for the current Subframe of the current Frame is reduced. This carrier reduction shall apply to all of the symbols of the current Subframe of the current Frame (see Section 7.2.3 for details). The values of 5, 6, and 7 for **L1D_reduced_carriers** shall be reserved.

L1D_guard_interval – This field shall indicate the guard interval length used for the OFDM symbols of the current Subframe as given in Table 9.13. Guard interval values from Table 9.13 (e.g. GI1_192) shall be as defined in Table 8.9.

Table 9.13 Signaling Format for **L1D_guard_interval** and **L1B_first_sub_guard_interval**

Value	Guard Interval	Value	Guard Interval
0000	Reserved	1000	GI8_2432
0001	GI1_192	1001	GI9_3072
0010	GI2_384	1010	GI10_3648
0011	GI3_512	1011	GI11_4096
0100	GI4_768	1100	GI12_4864
0101	GI5_1024	1101	Reserved
0110	GI6_1536	1110	Reserved
0111	GI7_2048	1111	Reserved

L1D_num_ofdm_symbols – This field shall be set equal to one less than the total number of data payload OFDM symbols, including any Subframe-boundary symbol(s), present within the current Subframe. The number of data payload OFDM symbols in a Subframe is greater than or equal to $4 \times D_Y$ where D_Y is taken from the scattered pilot pattern that is configured for the Subframe (see Section 7.2.4.2). OFDM symbols containing Preamble signaling shall not be included within this count.

L1D_scattered_pilot_pattern – This field shall indicate the scattered pilot pattern used for the current Subframe as given in Table 9.14 for SISO, and as given in Table 9.15 for MIMO. SP pattern values (e.g. SP3_2, MP3_2) shall be as defined in Table 8.2 (SISO) and Table L.9.2 (MIMO). Note that MP24_2, MP24_4, MP32_2, and MP32_4 are invalid pilot patterns when Walsh-Hadamard pilot encoding is configured with MIMO operation (see Section L.9.2).

Table 9.14 Signaling Format for **L1D_scattered_pilot_pattern** and **L1B_first_sub_scattered_pilot_pattern** for SISO

Value	SP pattern	Value	SP pattern	Value	SP pattern
0000	SP3_2	0100	SP12_2	1000	Reserved
0001	SP3_4	0101	SP12_4
0010	SP4_2	0110	SP16_2
0011	SP4_4	0111	SP16_4
0100	SP6_2	0110	SP24_2
0101	SP6_4	0111	SP24_4
0110	SP8_2	0111	SP32_2
0111	SP8_4	0111	SP32_4	1111	Reserved

Table 9.15 Signaling Format for **L1D_scattered_pilot_pattern** and **L1B_first_sub_scattered_pilot_pattern** for MIMO

Value	SP pattern	Value	SP pattern	Value	SP pattern
0000	MP3_2	0100	MP12_2	1000	Reserved
0001	MP3_4	0101	MP12_4
0010	MP4_2	0110	MP16_2
0011	MP4_4	0111	MP16_4
0100	MP6_2	0110	MP24_2
0101	MP6_4	0111	MP24_4
0110	MP8_2	0111	MP32_2
0111	MP8_4	0111	MP32_4	1111	Reserved

L1D_scattered_pilot_boost – The value of this field combined with the scattered pilot pattern shall represent the power of the scattered pilots (in dB) used for the current Subframe. The exact power values (used to calculate the amplitude) shall be as defined in Table 9.16. Equivalent but approximate amplitudes (after conversion from dB to linear) of the scattered pilots are listed in Table 9.17. The values of 101, 110 and 111 shall be reserved for future use (*RFU*).

Table 9.16 Signaling Format for **L1D_scattered_pilot_boost** (power in dB)

Pilot Pattern (SISO / MIMO)	L1D_scattered_pilot_boost							
	000	001	010	011	100	101	110	111
SP3_2 / MP3_2	0.00	0.00	1.40	2.20	2.90	<i>RFU</i>	<i>RFU</i>	<i>RFU</i>
SP3_4 / MP3_4	0.00	1.40	2.90	3.80	4.40	<i>RFU</i>	<i>RFU</i>	<i>RFU</i>
SP4_2 / MP4_2	0.00	0.60	2.10	3.00	3.60	<i>RFU</i>	<i>RFU</i>	<i>RFU</i>
SP4_4 / MP4_4	0.00	2.10	3.60	4.40	5.10	<i>RFU</i>	<i>RFU</i>	<i>RFU</i>
SP6_2 / MP6_2	0.00	1.60	3.10	4.00	4.60	<i>RFU</i>	<i>RFU</i>	<i>RFU</i>
SP6_4 / MP6_4	0.00	3.00	4.50	5.40	6.00	<i>RFU</i>	<i>RFU</i>	<i>RFU</i>
SP8_2 / MP8_2	0.00	2.20	3.80	4.60	5.30	<i>RFU</i>	<i>RFU</i>	<i>RFU</i>

SP8_4 / MP8_4	0.00	3.60	5.10	6.00	6.60	RFU	RFU	RFU
SP12_2 / MP12_2	0.00	3.20	4.70	5.60	6.20	RFU	RFU	RFU
SP12_4 / MP12_4	0.00	4.50	6.00	6.90	7.50	RFU	RFU	RFU
SP16_2 / MP16_2	0.00	3.80	5.30	6.20	6.80	RFU	RFU	RFU
SP16_4 / MP16_4	0.00	5.20	6.70	7.60	8.20	RFU	RFU	RFU
SP24_2 / MP24_2	0.00	4.70	6.20	7.10	7.70	RFU	RFU	RFU
SP24_4 / MP24_4	0.00	6.10	7.60	8.50	9.10	RFU	RFU	RFU
SP32_2 / MP32_2	0.00	5.40	6.90	7.70	8.40	RFU	RFU	RFU
SP32_4 / MP32_4	0.00	6.70	8.20	9.10	9.70	RFU	RFU	RFU

Table 9.17 Equivalent Signaling Format for **L1D_scattered_pilot_boost** (amplitude)

Pilot Pattern (SISO / MIMO)	L1D_scattered_pilot_boost							
	000	001	010	011	100	101	110	111
SP3_2 / MP3_2	1.000	1.000	1.175	1.288	1.396	RFU	RFU	RFU
SP3_4 / MP3_4	1.000	1.175	1.396	1.549	1.660	RFU	RFU	RFU
SP4_2 / MP4_2	1.000	1.072	1.274	1.413	1.514	RFU	RFU	RFU
SP4_4 / MP4_4	1.000	1.274	1.514	1.660	1.799	RFU	RFU	RFU
SP6_2 / MP6_2	1.000	1.202	1.429	1.585	1.698	RFU	RFU	RFU
SP6_4 / MP6_4	1.000	1.413	1.679	1.862	1.995	RFU	RFU	RFU
SP8_2 / MP8_2	1.000	1.288	1.549	1.698	1.841	RFU	RFU	RFU
SP8_4 / MP8_4	1.000	1.514	1.799	1.995	2.138	RFU	RFU	RFU
SP12_2 / MP12_2	1.000	1.445	1.718	1.905	2.042	RFU	RFU	RFU
SP12_4 / MP12_4	1.000	1.679	1.995	2.213	2.371	RFU	RFU	RFU
SP16_2 / MP16_2	1.000	1.549	1.841	2.042	2.188	RFU	RFU	RFU
SP16_4 / MP16_4	1.000	1.820	2.163	2.399	2.570	RFU	RFU	RFU
SP24_2 / MP24_2	1.000	1.718	2.042	2.265	2.427	RFU	RFU	RFU
SP24_4 / MP24_4	1.000	2.018	2.399	2.661	2.851	RFU	RFU	RFU
SP32_2 / MP32_2	1.000	1.862	2.213	2.427	2.630	RFU	RFU	RFU
SP32_4 / MP32_4	1.000	2.163	2.570	2.851	3.055	RFU	RFU	RFU

L1D_sbs_first – This flag shall indicate whether or not the first symbol of the current Subframe is a Subframe boundary symbol. **L1D_sbs_first**=0 shall indicate that the first symbol of the Subframe is not a Subframe boundary symbol. **L1D_sbs_first**=1 shall indicate that the first symbol of the Subframe is a Subframe boundary symbol.

L1D_sbs_last – This flag shall indicate whether or not the last symbol of the current Subframe is a Subframe boundary symbol. **L1D_sbs_last**=0 shall indicate that the last symbol of the Subframe is not a Subframe boundary symbol. **L1D_sbs_last**=1 shall indicate that the last symbol of the Subframe is a Subframe boundary symbol.

L1D_subframe_multiplex – This field shall indicate whether the current Subframe is time-division multiplexed / concatenated in time (**L1D_subframe_multiplex**=0) with adjacent Subframes. **L1D_subframe_multiplex**=1 shall be reserved for future use.

L1D_frequency_interleaver – This flag shall indicate whether the frequency interleaver is enabled or bypassed for the current Subframe. **L1D_frequency_interleaver**=1 shall indicate that the frequency interleaver is enabled, **L1D_frequency_interleaver**=0 shall indicate that the frequency interleaver is bypassed and not used.

L1D_sbs_null_cells – This field shall indicate the number of null cells in the Subframe boundary symbol(s) of the current Subframe. When there are no Subframe boundary symbols in the current Subframe, this field shall not be transmitted.

9.3.4 L1-Detail PLP Parameters

The following L1-Detail signaling fields are related to PLP characteristics.

L1D_num_plp – This field shall be set to 1 less than the total number of PLPs used within the current Subframe.

L1D_plp_id – This field shall be set equal to the ID of the current PLP, with a range from 0 to 63, inclusive. This field shall identify a PLP uniquely within each RF channel. For channel-bonded systems, the combination of **L1D_rf_id** and this field can be used to create a unique identifier for each PLP within the bonded system.

L1D_plp_lls_flag – This field shall indicate whether the current PLP carries LLS information. **L1D_plp_lls_flag**=0 shall indicate that the current PLP does not carry LLS information (in any Frame), while **L1D_plp_lls_flag**=1 shall indicate that the current PLP does carry LLS information (although not necessarily in the current Frame or Subframe). The purpose of this flag is to allow receivers to quickly locate upper layer signaling information. Receivers can use **L1B_lls_flag** to determine whether or not at least one PLP in the current Frame actually contains LLS information in the current Frame. Note, however, that certain broadcast configurations can result in multiple PLPs carrying LLS information within a single RF channel, and hence **L1B_lls_flag** being set does not necessarily indicate that the LLS-bearing PLP of interest to a particular receiver contains LLS information in the current Frame.

L1D_plp_size – This field shall be set equal to the number of data cells allocated to the current PLP within the current Subframe. **L1D_plp_size** shall be greater than zero.

L1D_plp_scrambler_type – This field shall indicate the choice of scrambler type for the PLP as given in Table 9.18.

Table 9.18 Signaling Format for **L1D_plp_scrambler_type**

Value	Description
00	Scrambler defined in Section 5.2.3
01	Reserved for future use
10	Reserved for future use
11	Reserved for future use

L1D_plp_fec_type – This field shall indicate the Forward Error Correction (FEC) method used for encoding the current PLP. The correspondence between a signaled value of **L1D_plp_fec_type** and a particular FEC method shall be as given in Table 9.19. Here, 16K LDPC refers to the LDPC FEC coding that generates a set of 16200 coded bits per code block, and 64K LDPC refers to the LDPC FEC coding that generates a set of 64800 coded bits per code block.

Table 9.19 Signaling Format for **L1D_plp_fec_type**

Value	Forward Error Correction Method
0000	BCH + 16K LDPC
0001	BCH + 64K LDPC
0010	CRC + 16K LDPC
0011	CRC + 64K LDPC
0100	16K LDPC only
0101	64K LDPC only
0110 - 1111	Reserved for future use

L1D_plp_mod – This field shall indicate the modulation used for the current PLP as given in Table 9.20 for SISO, and as given in Table 9.21 for MIMO. Modulations of 1024QAM-NUC and 4096QAM-NUC shall only be indicated when **L1D_plp_fec_type** for the same PLP indicates a 64K LDPC.

Table 9.20 Signaling Format for **L1D_plp_mod** for SISO

Value	Modulation
0000	QPSK
0001	16QAM-NUC
0010	64QAM-NUC
0011	256QAM-NUC
0100	1024QAM-NUC
0101	4096QAM-NUC
0110-1111	Reserved

Table 9.21 Signaling Format for **L1D_plp_mod** for MIMO

Value	Bits per Cell Unit	MIMO Modulation	
		Tx1	Tx2
0000	4	Tx1	QPSK
		Tx2	QPSK
0001	8	Tx1	16QAM-NUC
		Tx2	16QAM-NUC
0010	12	Tx1	64QAM-NUC
		Tx2	64QAM-NUC
0011	16	Tx1	256QAM-NUC
		Tx2	256QAM-NUC
0100	20	Tx1	1024QAM-NUC
		Tx2	1024QAM-NUC
0101	24	Tx1	4096QAM-NUC
		Tx2	4096QAM-NUC
0110 to 1111	Reserved	Reserved	

L1D_plp_cod – This field shall indicate the code rate used for the current PLP as shown in Table 9.22.

Table 9.22 Signaling Format for **L1D_plp_cod**

Value	Code Rate
0000	2/15
0001	3/15
0010	4/15
0011	5/15
0100	6/15
0101	7/15
0110	8/15
0111	9/15
1000	10/15
1001	11/15
1010	12/15
1011	13/15
1100-1111	Reserved

L1D_plp_TI_mode – This field shall indicate the time interleaving mode for the PLP as given in Table 9.23.

Table 9.23 Signaling Format for **L1D_plp_TI_mode**

Value	Time interleaving mode
00	No time interleaving mode (neither CTI nor HTI)
01	Convolutional time interleaving (CTI) mode
10	Hybrid time interleaving (HTI) mode
11	Reserved for future use

L1D_plp_fec_block_start – This field shall indicate the start position of the first complete FEC Block that begins within the current PLP during the current Subframe. **L1D_plp_fec_block_start** for a PLP shall indicate the relative position, within and relative to the start of that PLP's data cells for the current Subframe, of the first cell of the first complete FEC Block of the PLP beginning within the current Subframe. **L1D_plp_fec_block_start** shall be determined prior to cell multiplexing. When no FEC Block begins within the current PLP during the current Subframe, **L1D_plp_fec_block_start** shall be set to its maximum possible value (i.e. all bits of **L1D_plp_fec_block_start** shall be set to 1s). When LDM is used, **L1D_plp_fec_block_start** shall be signaled for both Core and Enhanced PLPs since the start positions of the first complete FEC Block of Core and Enhanced PLPs that have been layered division multiplexed together, in general, are different. **L1D_plp_fec_block_start** shall be signalled only when **L1D_plp_TI_mode**=00 (i.e. when no time interleaving mode is configured).

9.3.5 L1-Detail LDM Parameters

The following L1-Detail signaling fields are related to Layered Division Multiplexing (LDM).

L1D_plp_layer – This field shall be set equal to the layer index of the current PLP. **L1D_plp_layer**=0 shall correspond to the Core Layer, while **L1D_plp_layer**>0 shall correspond to an Enhanced Layer. For the current version of the specification, **L1D_plp_layer** shall be set only to values of 0 or 1. Presence in a Subframe of any PLP having **L1D_plp_layer** >0 shall indicate that the Subframe is to be configured for operation with LDM applied; Subframes having no PLPs present with **L1D_plp_layer** >0 shall be configured for operation with LDM not applied. These

conditions with respect to the value of the **L1D_plp_layer** field are the sole indicator of LDM operation in the related Subframe.

L1D_plp_ldm_injection_level – This field shall indicate the Enhanced PLP’s injection level relative to the Core PLP. The correspondence between a signaled value of **L1D_plp_ldm_injection_level** and a particular injection level shall be as given in Table 9.24. Injection levels are defined in Table 6.15. This field shall be included only when the index of the current layer is greater than 0 (i.e., when **L1D_plp_layer** >0). When LDM and MIMO are used simultaneously, the value of the injection level may take on a different meaning with respect to the two Polarization cases. The definitions for this scenario are provided in Section O.6.

Table 9.24 Signaling Format for **L1D_plp_ldm_injection_level**

Value	Injection level [dB]	Value	Injection level [dB]
0000	0.0	1000	11.0
0001	0.5	1001	12.0
0010	1.0	1010	13.0
0011	1.5	1011	14.0
0100	2.0	10100	15.0
0101	2.5	10101	16.0
0110	3.0	10110	17.0
0111	3.5	10111	18.0
01000	4.0	11000	19.0
01001	4.5	11001	20.0
01010	5.0	11010	21.0
01011	6.0	11011	22.0
01100	7.0	11100	23.0
01101	8.0	11101	24.0
01110	9.0	11110	25.0
01111	10.0	11111	Reserved

9.3.6 L1-Detail Channel Bonding Parameters (PLP)

The following L1-Detail signaling fields are related to channel bonding on a PLP basis. These signaling fields shall not be included when **L1D_num_rf**=0.

L1D_plp_num_channel_bonded – This field shall indicate the number of frequencies, not including the frequency of the present channel, involved in channel bonding of the current PLP. **L1D_plp_num_channel_bonded** shall have a maximum value of **L1D_num_rf**. When the current PLP is not channel bonded this shall be indicated by **L1D_plp_num_channel_bonded**=0. For the current version of the specification **L1D_plp_num_channel_bonded** shall have a maximum value of 1 (i.e. bonding with one other channel).

L1D_plp_bonded_rf_id – This field shall indicate the RF ids (**L1D_rf_id** values, which are not signaled parameters) of the channels that are used for channel bonding with the current PLP. It shall only be included when **L1D_plp_num_channel_bonded** > 0.

L1D_plp_channel_bonding_format – This field shall indicate the channel bonding format for the current PLP according to Table 9.25. When a PLP is bonded between multiple RF channels, the same bonding format shall be used for that PLP in each of those RF channels.

Table 9.25 Signaling Format for **L1D_plp_channel_bonding_format**

Value	Meaning
00	Plain channel bonding
01	SNR averaged channel bonding
10	Reserved for future use
11	Reserved for future use

9.3.7 L1-Detail MIMO Parameters (PLP)

The following L1-Detail signaling fields are related to MIMO on a PLP-by-PLP basis.

L1D_plp_mimo – This field shall indicate whether MIMO (see Annex L and Annex O) is used for a given PLP when the current Subframe contains PLPs both using and not using MIMO. This field shall be signaled when **L1B_first_sub_mimo_mixed** or **L1D_mimo_mixed** (as appropriate for the current Subframe) has a value of 1. A value of 1 shall indicate that MIMO is used, and a value of 0 shall indicate that MIMO is not used. When LDM is applied to the Subframe identified by **L1B_first_sub_mimo_mixed**=1 or **L1D_mimo_mixed**=1, only Enhanced PLP(s) shall use MIMO.

L1D_plp_mimo_stream_combining – This flag shall indicate whether the stream combining option of MIMO precoding is used in the given PLP, as described in Section L.5.1. A value of 1 shall indicate that stream combining is used, and a value of 0 shall indicate that the stream combining option is not used.

L1D_plp_mimo_IQ_interleaving – This flag shall indicate whether the IQ polarization interleaving option of MIMO precoding is used in the given PLP, as described in Section L.5.2. A value of 1 shall indicate that IQ polarization interleaving is used, and a value of 0 shall indicate that the IQ polarization interleaving option is not used.

L1D_plp_mimo_PH – This flag shall indicate whether the phase hopping option of MIMO precoding is used in the given PLP, as described in Section L.5.3. A value of 1 shall indicate that phase hopping is used, and a value of 0 shall indicate that the phase hopping option is not used.

9.3.8 L1-Detail Cell Multiplexing Parameters

The following L1-Detail signaling fields are related to cell multiplexing.

L1D_plp_start – This field shall be set equal to the index of the data cell that holds the first data cell of the current PLP in the current Subframe.

L1D_plp_type – This flag shall be set to **L1D_plp_type**=0 when the current PLP is non-dispersed (i.e. all data cells of the current PLP have contiguous logical addresses and subslicing is not used for the current PLP) or to **L1D_plp_type**=1 when the current PLP is dispersed (i.e. not all data cells of the current PLP have contiguous logical addresses and subslicing is used for the current PLP). **L1D_plp_type** shall only be present when **L1D_plp_layer**=0 (i.e. only Core PLPs have a PLP type associated with them).

L1D_plp_num_subsllices – This field shall only be included when **L1D_plp_type**=1 and shall be set equal to one less than the actual number of subslices used for the current PLP within the current Subframe. **L1D_plp_num_subsllices**=0 shall be a reserved value, since it is not possible for a dispersed PLP to have only one subslice. The maximum allowable value for **L1D_plp_num_subsllices** shall be 16383, corresponding to 16384 actual subslices. **L1D_plp_num_subsllices** shall be set for each dispersed PLP.

L1D_plp_subslice_interval – This field shall only be included when **L1D_plp_type**=1 and shall be set equal to the number of sequentially-indexed data cells measured from the beginning of a

subslice for a PLP to the beginning of the next subslice for the same PLP. As an illustrative example, if **L1D_plp_start**=100 and **L1D_plp_subslice_interval**=250, then the first data cell of the first subslice of the current PLP would be located at index 100, and the first data cell of the second subslice of the current PLP would be located at index 100+250=350. **L1D_plp_subslice_interval** shall be set for each dispersed PLP.

9.3.9 L1-Detail Time Interleaver (TI) Parameters

L1D_plp_TI_extended_interleaving – This flag shall indicate whether extended interleaving is used for this PLP. A value of 1 shall indicate that extended interleaving is used. A value of 0 shall indicate that extended interleaving is not used. A value of 1 shall not be selected when LDM is used.

9.3.9.1 Convolutional Time Interleaver Mode Parameters

The following parameters shall indicate the configuration of the Convolutional Time Interleaver in CTI mode.

L1D_plp_CTI_depth – This field shall indicate the number of rows used in the Convolutional Time Interleaver. **L1D_plp_CTI_depth** shall be signaled according to Table 9.26.

Table 9.26 Signaling Format for **L1D_plp_CTI_depth**

Value	Number of Rows
000	512
001	724
010	887 (non-extended interleaving) or 1254 (extended interleaving)
011	1024 (non-extended interleaving) or 1448 (extended interleaving)
100	Reserved for future use
101	Reserved for future use
110	Reserved for future use
111	Reserved for future use

L1D_plp_CTI_start_row – This field shall indicate the position of the commutator selector at the start of the Subframe.

L1D_plp_CTI_fec_block_start – This field shall indicate the position, after the CTI, of the first cell of the first complete FEC Block, before the CTI, for the current PLP in the current or a subsequent Subframe. This position shall be specified relative to the first cell of the current PLP leaving the CTI in the current Subframe, for which the commutator is at position **L1D_plp_CTI_start_row**. **L1D_plp_CTI_fec_block_start** may exceed Subframe boundaries and thus may indicate a position in the PLP data that belongs to a subsequent Subframe. **L1D_plp_CTI_fec_block_start** shall be determined prior to cell multiplexing.

L1D_plp_CTI_fec_block_start can be determined as follows. Let C be the position of the first cell of the first complete FEC Block before the CTI of the current PLP in the current or a subsequent Subframe, where the indexing of C starts at 0, where 0 corresponds to the first cell, before the CTI, of the current PLP. Note that C will also be equal to the number of cells that belong to the immediately preceding FEC Block of the PLP and which have not yet been input to the CTI. Then $\mathbf{L1D_plp_CTI_fec_block_start} = C + N_{\text{rows}} \times ((\mathbf{L1D_plp_CTI_start_row} + C) \text{ modulo } N_{\text{rows}})$. Figure 9.2 shows graphically the calculation of **L1D_plp_CTI_fec_block_start**.

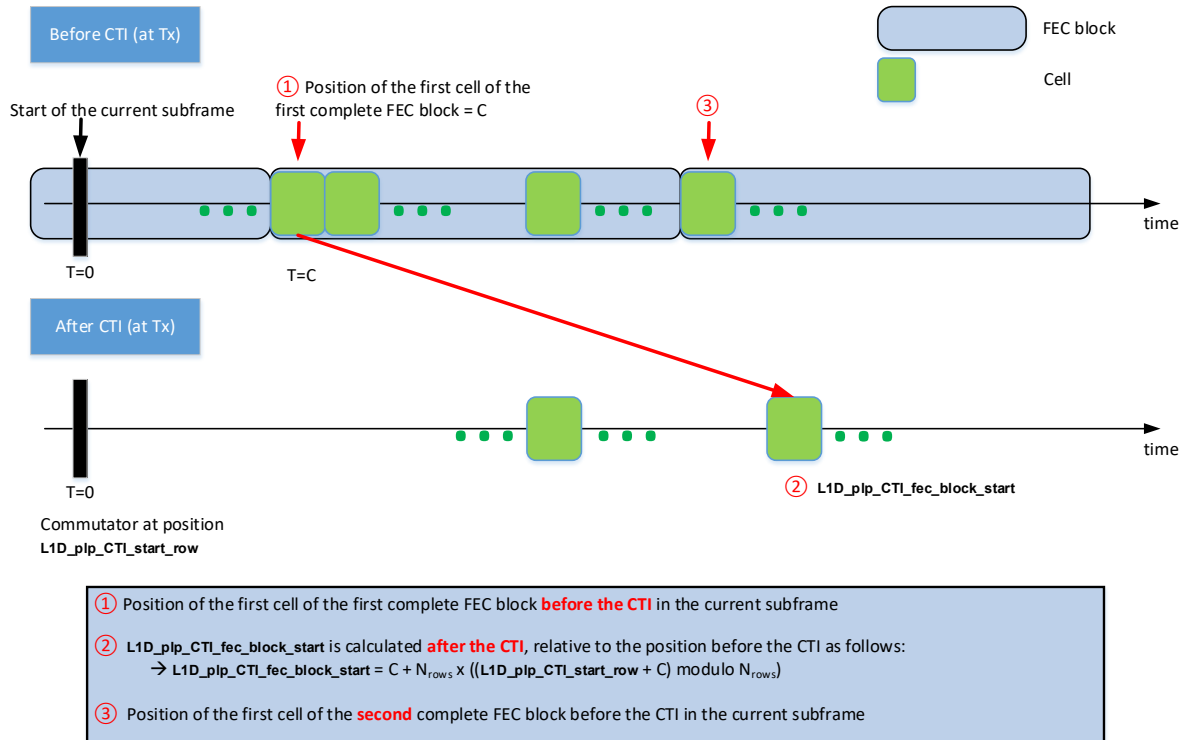

Figure 9.2 $L1D_plp_CTI_fec_block_start$ graphical description.

When LDM is used, $L1D_plp_CTI_fec_block_start$ shall be signaled separately for both Core PLPs and Enhanced PLPs since the start positions of the first complete FEC Blocks of Core PLPs and Enhanced PLPs that have been layered division multiplexed together are in general different.

9.3.9.2 Hybrid Time Interleaver (Mode) Parameters

The following parameters shall indicate the configuration of the Hybrid Time Interleaver which shall be used when HTI mode is configured for the current PLP.

$L1D_plp_HTI_inter_subframe$ – This field shall indicate the hybrid time interleaving mode. $L1D_plp_HTI_inter_subframe=0$ shall indicate that inter-Subframe interleaving is not used (i.e. only intra-Subframe interleaving is used). $L1D_plp_HTI_inter_subframe=1$ shall indicate that inter-Subframe interleaving is used with one TI Block per interleaving frame spread over multiple Subframes.

$L1D_plp_HTI_num_ti_blocks$ – This field shall indicate either the number of TI Blocks per interleaving frame, N_{TI} , when $L1D_plp_HTI_inter_subframe=0$ or the number of Subframes, N_{IU} , over which cells from one TI Block are carried when $L1D_plp_HTI_inter_subframe=1$. The value indicated by $L1D_plp_HTI_num_ti_blocks$ shall be one less than the actual value of N_{TI} or N_{IU} to permit a range from 1 to 16 to be signaled.

$L1D_plp_HTI_num_fec_blocks_max$ – This field shall indicate one less than the maximum number of FEC Blocks per interleaving frame for the current PLP.

$L1D_plp_HTI_num_fec_blocks$ – This field shall indicate one less than the number of FEC Blocks contained in the current interleaving frame for the current PLP. When $L1D_plp_HTI_inter_subframe=1$ (i.e., when the HTI is configured for inter-Subframe interleaving), $L1D_plp_HTI_num_fec_blocks$ at index $k=0$ (in Table 9.9) indicates one less than the number of FEC Blocks in the interleaving frame that begins in the current Subframe.

L1D_plp_HTI_num_fec_blocks at index $k=1$ indicates one less than the number of FEC Blocks in the interleaving frame that began in the previous Subframe that contained the current PLP, and so on.

L1D_plp_HTI_cell_interleaver – This flag shall indicate whether the Cell Interleaver is used. A value of 1 shall indicate that the Cell Interleaver is used, and a value of 0 shall indicate that the Cell Interleaver is not used.

Annex A: LDPC Codes

A.1 LDPC CODE MATRICES ($N_{INNER} = 64800$)

Table A.1.1 Rate = 2/15 ($N_{inner} = 64800$)

615	898	1029	6129	8908	10620	13378	14359	21964	23319	26427	26690	28128	33435	36080	40697	43525	44498	50994
165	1081	1637	2913	8944	9639	11391	17341	22000	23580	32309	38495	41239	44079	47395	47460	48282	51744	52782
426	1340	1493	2261	10903	13336	14755	15244	20543	29822	35283	38846	45368	46642	46934	48242	49000	49204	53370
407	1059	1366	2004	5985	9217	9321	13576	19659	20808	30009	31094	32445	39094	39357	40651	44358	48755	49732
692	950	1444	2967	3929	6951	10157	10326	11547	13562	19634	34484	38236	42918	44685	46172	49694	50535	55109
1087	1458	1574	2335	3248	6965	17856	23454	25182	37359	37718	37768	38061	38728	39437	40710	46298	50707	51572
1098	1540	1711	7723	9549	9986	16369	19567	21185	21319	25750	32222	32463	40342	41391	43869	48372	52149	54722
514	1283	1635	6602	11333	11443	17690	21036	22936	24525	25425	27103	28733	29551	39204	42525	49200	54899	54961
357	609	1096	2954	4240	5397	8425	13974	15252	20167	20362	21623	27190	42744	47819	49096	51995	55504	55719
25	448	1501	11572	13478	24338	29198	29840	31428	33088	34724	37698	37988	38297	40482	46953	47880	53751	54943
328	1096	1262	10802	12797	16053	18038	20433	20444	25422	32992	34344	38326	41435	46802	48766	49807	52966	55751
34	790	987	5082	5788	10778	12824	18217	23278	24737	28312	34464	36765	37999	39603	40797	43237	53089	55319
226	1149	1470	3483	8949	9312	9773	13271	17804	20025	20323	30623	38575	39887	40305	46986	47223	49998	52111
1088	1091	1757	2682	5526	5716	9665	10733	12997	14440	24665	27990	30203	33173	37423	38934	40494	45418	48393
809	1278	1580	3486	4529	6117	6212	6823	7861	9244	11559	20736	30333	32450	35528	42968	44485	47149	54913
369	525	1622	2261	6454	10483	11259	16461	17031	20221	22710	25137	26622	27904	30884	31858	44121	50690	56000
423	1291	1352	7883	26107	26157	26876	27071	31515	35340	35953	36608	37795	37842	38527	41720	46206	47998	53019
540	662	1433	2828	14410	22880	24263	24802	28242	28396	35928	37214	39748	43915	44905	46590	48684	48890	55926
214	1291	1622	7311	8985	20952	22752	23261	24896	25057	28826	37074	37707	38742	46026	51116	51521	52956	54213
109	1305	1676	2594	7447	8943	14806	16462	19730	23430	24542	34300	36432	37133	41199	43942	45860	47598	48401
242	388	1360	6721	14220	21029	22536	25126	32251	33182	39192	42436	44144	45252	46238	47369	47607	47695	50635
199	958	1111	13661	18809	19234	21459	25221	25837	28256	36919	39031	39107	39262	43572	45018	45959	48006	52387
668	1087	1451	2945	3319	12519	21248	21344	22627	22701	28152	29670	31430	32655	38533	42233	43200	44013	44459
244	1133	1665	8222	8740	11285	12774	15922	20147	20978	28927	35086	40197	40583	41066	41223	42104	44650	45391
5623	8050	9679	12978	15846	16049	21807	23364	27226	27758	28661	38147	46337	48141	51364	51927	55124		
10369	13704	14491	18632	19430	21218	33392	36182	36722	37342	37415	46322	47449	51136	53392	54356	55108		
7460	9411	11132	11739	13722	15501	25588	26463	26738	31980	31981	35002	39659	39783	41581	51358	55114		
8915	15253	15264	16513	16896	18367	19110	23492	32074	33302	42443	43797	44715	47538	48515	53464	53548		
5884	8910	10123	11311	13654	14207	16122	18113	23100	23784	24825	39629	46372	52454	52799	55039	55973		

Table A.1.2 Rate = 3/15 ($N_{inner} = 64800$)

920	963	1307	2648	6529	17455	18883	19848	19909	24149	24249	38395	41589	48032	50313
297	736	744	5951	8438	9881	15522	16462	23036	25071	34915	41193	42975	43412	49612
10	223	879	4662	6400	8691	14561	16626	17408	22810	31795	32580	43639	45223	47511
629	842	1666	3150	7596	9465	12327	18649	19052	19279	29743	30197	40106	48371	51155
857	953	1116	8725	8726	10508	17112	21007	30649	32113	36962	39254	46636	49599	50099
700	894	1128	5527	6216	15123	21510	24584	29026	31416	37158	38460	42511	46932	51832
430	592	1521	3018	10430	18090	18092	18388	20017	34383	35006	38255	41700	42158	45211
91	1485	1733	11624	12969	17531	21324	23657	27148	27509	28753	35093	43352	48104	51648
18	34	117	6739	8679	11018	12163	16733	24113	25906	30605	32700	36465	40799	43359
481	1545	1644	4216	4606	6015	6609	14659	16966	18056	19137	26670	28001	30668	49061
174	1208	1387	10580	11507	13751	16344	22735	23559	26492	27672	33399	44787	44842	45992
1151	1185	1472	6727	10701	14755	15688	17441	21281	23692	23994	31366	35854	37301	43148
200	799	1583	3451	5880	7604	8194	13428	16109	18584	20463	22373	31977	47073	50087
346	843	1352	13409	17376	18233	19119	19382	20578	24183	32052	32912	43204	48539	49893
76	457	1169	13516	14520	14638	22391	25294	31067	31325	36711	44072	44854	49274	51624
759	798	1420	6661	12101	12573	13796	15510	18384	26649	30875	36856	38994	43634	49281
551	797	1000	3999	10040	11246	15793	23298	23822	38480	39209	45334	46603	46625	47633
441	875	1554	5336	25948	28842	30329	31503	39203	39673	46250	47021	48555	49229	51421
963	1470	1642	3180	3943	6513	9125	15641	17083	18876	28499	32764	42420	43922	45762
293	324	867	8803	10582	17926	19830	22497	24848	30034	34659	37721	41523	42534	47806
687	975	1356	2721	3002	3874	4119	12336	17119	21251	22482	22833	24681	26225	48514
549	951	1268	9144	11710	12623	18949	19362	22769	32603	34559	34683	36338	47140	51069
52	890	1669	3905	5670	14712	18314	22297	30328	33389	35447	35512	35516	40587	41918
656	1063	1694	3338	3793	4513	6009	7441	13393	20920	26501	27576	29623	31261	42093
425	1018	1086	9226	10024	17552	24714	24877	25853	28918	30945	31205	33103	42564	47214
32	1145	1438	4916	4945	14830	17505	19919	24118	28506	30173	31754	34230	48608	50291
559	1216	1272	2856	8703	9371	9708	16180	19127	24337	26390	36649	41105	42988	44096
362	658	1191	7769	8998	14068	15921	18471	18780	31995	32798	32864	37293	39468	44308
1136	1389	1785	8800	12541	14723	15210	15859	26569	30127	31357	32898	38760	50523	51715
44	80	1368	2010	2228	6614	6767	9275	25237	30208	39537	42041	49906	50701	51199
1522	1536	1765	3914	5350	10869	12278	12886	16379	22743	23987	26306	30966	33854	41356
212	648	709	3443	7007	7545	12484	13358	17008	20433	25862	31945	39207	39752	40313
789	1062	1431	12280	17415	18098	23729	37278	38454	38763	41039	44600	50700	51139	51696
825	1298	1391	4882	12738	17569	19177	19896	27401	37041	39181	39199	41832	43636	45775
992	1053	1485	3806	16929	18596	22017	23435	23932	30211	30390	34469	37213	46220	49646
771	850	1039	5180	7653	13547	17980	23365	25318	34374	36115	38753	42993	49696	51031
7383	14780	15959	18921	22579	28612	32038	36727	40851	41947	42707	50480			
8733	9464	13148	13899	19396	22933	23039	25047	29938	33588	33796	48930			
2493	12555	16706	23905	35400	36330	37065	38866	40305	43807	43917	50621			
6437	11927	14542	16617	17317	17755	18832	24772	29273	31136	36925	46663			
2191	3431	6288	6430	9908	13069	23014	24822	29818	39914	46010	47246			

Table A.1.3 Rate = 4/15 ($N_{inner} = 64800$)

276	1754	1780	3597	8549	15196	26305	27003	33883	37189	41042	41849	42356
730	873	927	9310	9867	17594	21969	25106	25922	31167	35434	37742	45866
925	1202	1564	2575	2831	2951	5193	13096	18363	20592	33786	34090	40900
973	1045	1071	8545	8980	11983	18649	21323	22789	22843	26821	36720	37856
402	1038	1689	2466	2893	13474	15710	24137	29709	30451	35568	35966	46436
263	271	395	5089	5645	15488	16314	28778	29729	34350	34533	39608	45371
387	1059	1306	1955	6990	20001	24606	28167	33802	35181	38481	38688	45140
53	851	1750	3493	11415	18882	20244	23411	28715	30722	36487	38019	45416
810	1044	1772	3906	5832	16793	17333	17910	23946	29650	34190	40673	45828
97	491	948	12156	13788	24970	33774	37539	39750	39820	41195	46464	46820
192	899	1283	3732	7310	13637	13810	19005	24227	26772	31273	37665	44005
424	531	1300	4860	8983	10137	16323	16888	17933	22458	26917	27835	37931
130	279	731	3024	6378	18838	19746	21007	22825	23109	28644	32048	34667
938	1041	1482	9589	10065	11535	17477	25816	27966	35022	35025	42536	
170	454	1312	5326	6765	23408	24090	26072	33037	38088	42985	46413	
220	804	843	2921	4841	7760	8303	11259	21058	21276	34346	37604	
676	713	832	11937	12006	12309	16329	26438	34214	37471	38179	42420	
714	931	1580	6837	9824	11257	15556	26730	32053	34461	35889	45821	
28	1097	1340	8767	9406	17253	29558	32857	37856	38593	41781	47101	
158	722	754	14489	23851	28160	30371	30579	34963	44216	46462	47463	
833	1326	1332	7032	9566	11011	21424	26827	29789	31699	32876	37498	
251	504	1075	4470	7736	11242	20397	32719	34453	36571	40344	46341	
330	581	868	15168	20265	26354	33624	35134	38609	44965	45209	46909	
729	1643	1732	3946	4912	9615	19699	30993	33658	38712	39424	46799	
546	982	1274	9264	11017	11868	15674	16277	19204	28606	39063	43331	
73	1160	1196	4334	12560	13583	14703	18270	18719	19327	38985	46779	
1147	1625	1759	3767	5912	11599	18561	19330	29619	33671	43346	44098	
104	1507	1586	9387	17890	23532	27008	27861	30966	33579	35541	39801	
1700	1746	1793	4941	7814	13746	20375	27441	30262	30392	35385	42848	
183	555	1029	3090	5412	8148	19662	23312	23933	28179	29962	35514	
891	908	1127	2827	4077	4376	4570	26923	27456	33699	43431	46071	
404	1110	1782	6003	14452	19247	26998	30137	31404	31624	46621	47366	
886	1627	1704	8193	8980	9648	10928	16267	19774	35111	38545	44735	
268	380	1214	4797	5168	9109	9288	17992	21309	33210	36210	41429	
572	1121	1165	6944	7114	20978	23540	25863	26190	26365	41521	44690	
18	185	496	5885	6165	20468	23895	24745	31226	33680	37665	38587	
289	527	1118	11275	12015	18088	22805	24679	28262	30160	34892	43212	
658	926	1589	7634	16231	22193	25320	26057	26512	27498	29472	34219	
337	801	1525	2023	3512	16031	26911	32719	35620	39035	43779	44316	
248	534	670	6217	11430	24090	26509	28712	33073	33912	38048	39813	
82	1556	1575	7879	7892	14714	22404	22773	25531	34170	38203	38254	
247	313	1224	3694	14304	24033	26394	28101	37455	37859	38997	41344	
790	887	1418	2811	3288	9049	9704	13303	14262	38149	40109	40477	
1310	1384	1471	3716	8250	25371	26329	26997	30138	40842	41041	44921	
86	288	367	1860	8713	18211	22628	22811	28342	28463	40415	45845	
719	1438	1741	8258	10797	29270	29404	32096	34433	34616	36030	45597	
215	1182	1364	8146	9949	10498	18603	19304	19803	23685	43304	45121	
1243	1496	1537	8484	8851	16589	17665	20152	24283	28993	34274	39795	
6320	6785	15841	16309	20512	25804	27421	28941	43871	44647			
2207	2713	4450	12217	16506	21188	23933	28789	38099	42392			
14064	14307	14599	14866	17540	18881	21065	25823	30341	36963			
14259	14396	17037	26769	29219	29319	31689	33013	35631	37319			
7798	10495	12868	14298	17221	23344	31908	39809	41001	41965			

Table A.1.4 Rate = 5/15 ($N_{inner} = 64800$)

221 1011 1218 4299 7143 8728 11072 15533 17356 33909 36833
 360 1210 1375 2313 3493 16822 21373 23588 23656 26267 34098
 544 1347 1433 2457 9186 10945 13583 14858 19195 34606 37441
 37 596 715 4134 8091 12106 24307 24658 34108 40591 42883
 235 398 1204 2075 6742 11670 13512 23231 24784 27915 34752
 204 873 890 13550 16570 19774 34012 35249 37655 39885 42890
 221 371 514 11984 14972 15690 28827 29069 30531 31018 43121
 280 549 1435 1889 3310 10234 11575 15243 20748 30469 36005
 223 666 1248 13304 14433 14732 18943 21248 23127 38529 39272
 370 819 1065 9461 10319 25294 31958 33542 37458 39681 40039
 585 870 1028 5087 5216 12228 16216 16381 16937 27132 27893
 164 167 1210 7386 11151 20413 22713 23134 24188 36771 38992
 298 511 809 4620 7347 8873 19602 24162 29198 34304 41145
 105 830 1212 2415 14759 15440 16361 16748 22123 32684 42575
 659 665 668 6458 22130 25972 30697 31074 32048 36078 37129
 91 808 953 8015 8988 13492 13987 15979 28355 34509 39698
 594 983 1265 3028 4029 9366 11069 11512 27066 40939 41639
 506 740 1321 1484 10747 16376 17384 20285 31502 38925 42606
 338 356 975 2022 3578 18689 18772 19826 22914 24733 27431
 709 1264 1366 4617 8893 25226 27800 29080 30277 37781 39644
 840 1179 1338 2973 3541 7043 12712 15005 17149 19910 36795
 1009 1267 1380 4919 12679 22889 29638 30987 34637 36232 37284
 466 913 1247 1646 3049 5924 9014 20539 34546 35029 36540
 374 697 984 1654 5870 10883 11684 20294 28888 31612 34031
 117 240 635 5093 8673 11323 12456 14145 21397 39619 42559
 122 1265 1427 13528 14282 15241 16852 17227 34723 36836 39791
 595 1180 1310 6952 17916 24725 24971 27243 29555 32138 35987
 140 470 1017 13222 13253 18462 20806 21117 28673 31598 37235
 7 710 1072 8014 10804 13303 14292 16690 26676 36443 41966
 48 189 759 12438 14523 16388 23178 27315 28656 29111 29694
 285 387 410 4294 4467 5949 25386 27898 34880 41169 42614
 474 545 1320 10506 13186 18126 27110 31498 35353 36193 37322
 1075 1130 1424 11390 13312 14161 16927 25071 25844 34287 38151
 161 396 427 5944 17281 22201 25218 30143 35566 38261 42513
 233 247 694 1446 3180 3507 9069 20764 21940 33422 39358
 271 508 1013 6271 21760 21858 24887 29808 31099 35475 39924
 8 674 1329 3135 5110 14460 28108 28388 31043 31137 31863
 1035 1222 1409 8287 16083 24450 24888 29356 30329 37834 39684
 391 1090 1128 1866 4095 10643 13121 14499 20056 22195 30593
 55 161 1402 6289 6837 8791 17937 21425 26602 30461 37241
 110 377 1228 6875 13253 17032 19008 23274 32285 33452 41630
 360 638 1355 5933 12593 13533 23377 23881 24586 26040 41663
 535 1240 1333 3354 10860 16032 32573 34908 34957 39255 40759
 526 936 1321 7992 10260 18527 28248 29356 32636 34666 35552
 336 785 875 7530 13062 13075 18925 27963 28703 33688 36502
 36 591 1062 1518 3821 7048 11197 17781 19408 22731 24783
 214 1145 1223 1546 9475 11170 16061 21273 38688 40051 42479
 1136 1226 1423 20227 22573 24951 26462 29586 34915 42441 43048
 26 276 1425 6048 7224 7917 8747 27559 28515 35002 37649
 127 294 437 4029 8585 9647 11904 24115 28514 36893 39722
 748 1093 1403 9536 19305 20468 31049 38667 40502 40720 41949
 96 638 743 9806 12101 17751 22732 24937 32007 32594 38504
 649 904 1079 2770 3337 9158 20125 24619 32921 33698 35173
 401 518 984 7372 12438 12582 18704 35874 39420 39503 39790
 10 451 1077 8078 16320 17409 25807 28814 30613 41261 42955
 405 592 1178 15936 18418 19585 21966 24219 30637 34536 37838
 50 584 851 9720 11919 22544 22545 25851 35567 41587 41876
 911 1113 1176 1806 10058 10809 14220 19044 20748 29424 36671
 441 550 1135 1956 11254 18699 30249 33099 34587 35243 39952
 510 1016 1281 8621 13467 13780 15170 16289 20925 26426 34479
 4969 5223 17117 21950 22144 24043 27151 39809
 11452 13622 18918 19670 23995 32647 37200 37399
 6351 6426 13185 13973 16699 22524 31070 31916
 4098 10617 14854 18004 28580 36158 37500 38552

Table A.1.5 Rate = 6/15 ($N_{inner} = 64800$)

1606 3402 4961 6751 7132 11516 12300 12482 12592 13342 13764 14123 21576 23946 24533 25376 25667 26836 31799 34173 35462 36153 36740 37085 37152 37468 37658
4621 5007 6910 8732 9757 11508 13099 15513 16335 18052 19512 21319 23663 25628 27208 31353 32219 33003 33239 33447 36200 36473 36938 37201 37283 37495 38642
16 1094 2020 3080 4194 5098 5631 6877 7889 8237 9804 10067 11017 11366 13136 13354 15379 16934 20199 24522 26172 28666 30386 32714 36390 37015 37162
700 897 1708 6017 6490 7372 7825 9546 10398 16605 18561 18745 21625 22137 23693 24340 24966 25015 26995 28586 28895 29667 33938 34520 34858 37056 38297
159 2010 2573 3617 4452 4958 5556 5832 6481 8227 9924 10836 14954 15594 16623 18065 19249 22394 22677 23408 23731 24076 24776 27007 28222 30343 38371
3118 3545 4768 4992 5227 6732 8170 9397 10522 11508 15536 20218 21921 28599 29445 29758 29968 31014 32027 33685 34378 35867 36323 36728 36870 38335 38623
1264 4254 6936 9165 9486 9950 10861 11653 13697 13961 15164 15665 18444 19470 20313 21189 24371 26431 26999 28086 28251 29261 31981 34015 35850 36129 37186
111 1307 1628 2041 2524 3538 7988 8191 10322 11905 12919 14127 15515 15711 17061 19024 21195 22902 23727 24401 24608 25111 25228 27338 35398 37794 38196
961 3035 7174 7948 13355 13607 14971 18189 18339 18665 18875 19142 20615 21136 21309 21758 23366 24745 25849 25982 27583 30006 31118 32106 36469 36583 37920
2990 3549 4273 4808 5707 6021 6509 7456 8240 10044 12262 12660 13085 14750 15680 16049 21587 23997 25803 28343 28693 34393 34860 35490 36021 37737 38296
955 4323 5145 6885 8123 9730 11840 12216 19194 20313 23056 24248 24830 25268 26617 28801 28557 29753 30745 31450 31973 32839 33025 33296 35710 37366 37509
264 605 4181 4483 5156 7238 8863 10939 11251 12964 16254 17511 20017 22395 22818 23261 23422 24064 26329 27723 28186 30434 31956 33971 34372 36764 38123
520 2562 2794 3528 3860 4402 5676 6963 8655 9018 9783 11933 16336 17193 17320 19035 20606 23579 23769 24123 24966 27866 32457 34011 34499 36620 37526
10106 10637 10906 34242
1856 15100 19378 21848
943 11191 27806 29411
4575 6359 13629 19383
4476 4953 18782 24313
5441 6381 21840 35943
9638 9763 12546 30120
9587 10626 11047 25700
4088 15298 28768 35047
2332 6363 8782 28863
4625 4933 28298 30289
3541 4918 18257 31746
1221 25233 26757 34892
8150 16677 27934 30021
8500 25016 33043 38070
7374 10207 16189 35811
611 18480 20064 38261
25416 27352 36089 38469
1667 17614 25839 32776
4118 12481 21912 37945
5573 13222 23619 31271
18271 26251 27182 30587
14690 26430 26799 34355
13688 16040 20716 34558
2740 14957 23436 32540
3491 14365 14681 36858
4796 6238 25203 27854
1731 12816 17344 26025
19182 21662 23742 27872
6502 13641 17509 34713
12246 12372 16746 27452
1589 21528 30621 34003
12328 20515 30651 31432
3415 22656 23427 36395
632 5209 25958 31085
619 3690 19648 37778
9528 13581 26965 36447
2147 26249 26968 28776
15698 18209 30693
1132 19888 34111
4608 25513 38874
475 1729 34100
7348 32277 38587
182 16473 33082
3865 9678 21265
4447 20151 27618
6335 14371 38711
704 9695 28858
4856 9757 30546
1993 19361 30732
756 28000 29138
3821 24076 31813
4611 12326 32291
7628 21515 34995
1246 13294 30068
6466 33233 35865
14484 23274 38150
21269 36411 37450
23129 26195 37653

Table A.1.6 Rate = 7/15 ($N_{inner} = 64800$)

460 792 1007 4580 11452 13130 26882 27020 32439
35 472 1056 7154 12700 13326 13414 16828 19102
45 440 772 4854 7863 26945 27684 28651 31875
744 812 892 1509 9018 12925 14140 21357 25106
271 474 761 4268 6706 9609 19701 19707 24870
223 477 662 1987 9247 18376 22148 24948 27694
44 379 786 8823 12322 14666 16377 28688 29924
104 219 562 5832 19665 20615 21043 22759 32180
41 43 870 7963 13718 14136 17216 30470 33428
592 744 887 4513 6192 18116 19482 25032 34095
456 821 1078 7162 7443 8774 15567 17243 33085
151 666 977 6946 10358 11172 18129 19777 32234
236 793 870 2001 6805 9047 13877 30131 34252
297 698 772 3449 4204 11608 22950 26071 27512
202 428 474 3205 3726 6223 7708 20214 25283
139 719 915 1447 2938 11864 15932 21748 28598
135 853 902 3239 18590 20579 30578 33374 34045
9 13 971 11834 13642 17628 21669 24741 30965
344 531 730 1880 16895 17587 21901 28620 31957
7 192 380 3168 3729 5518 6827 20372 34168
28 521 681 4313 7465 14209 21501 23364 25980
269 393 898 3561 11066 11985 17311 26127 30309
42 82 707 4880 4890 9818 23340 25959 31695
189 262 707 6573 14082 22259 24230 24390 24664
383 568 573 5498 13449 13990 16904 22629 34203
585 596 820 2440 2488 21956 28261 28703 29591
755 763 795 5636 16433 21714 23452 31150 34545
23 343 669 1159 3507 13096 17978 24241 34321
316 384 944 4872 8491 18913 21085 23198 24798
64 314 765 3706 7136 8634 14227 17127 23437
220 693 899 8791 12417 13487 18335 22126 27428
285 794 1045 8624 8801 9547 19167 21894 32657
386 621 1045 1634 1882 3172 13686 16027 22448
95 622 693 2827 7098 11452 14112 18831 31308
446 813 928 7976 8935 13146 27117 27766 33111
89 138 241 3218 9283 20458 31484 31538 34216
277 420 704 9281 12576 12788 14496 15357 20585
141 643 758 4894 10264 15144 16357 22478 26461
17 108 160 13183 15424 17939 19276 23714 26655
109 285 608 1682 20223 21791 24615 29622 31983
123 515 622 7037 13946 15292 15606 16262 23742
264 565 923 6460 13622 13934 23181 25475 26134
202 548 789 8003 10993 12478 16051 25114 27579
121 450 575 5972 10062 18693 21852 23874 28031
507 560 889 12064 13316 19629 21547 25461 28732
664 786 1043 9137 9294 10163 23389 31436 34297
45 830 907 10730 16541 21232 30354 30605 31847
203 507 1060 6971 12216 13321 17861 22671 29825
369 881 952 3035 12279 12775 17682 17805 34281
683 709 1032 3787 17623 24138 26775 31432 33626
524 792 1042 12249 14765 18601 25811 32422 33163
137 639 688 7182 8169 10443 22530 24597 29039
159 643 749 16386 17401 24135 28429 33468 33469
107 481 555 7322 13234 19344 23498 26581 31378
249 389 523 3421 10150 17616 19085 20545 32069
395 738 1045 2415 3005 3820 19541 23543 31068
27 293 703 1717 3460 8326 8501 10290 32625
126 247 515 6031 9549 10643 22067 29490 34450
331 471 1007 3020 3922 7580 23358 28620 30946
222 542 1021 3291 3652 13130 16349 33009 34348
532 719 1038 5891 7528 23252 25472 31395 31774
145 398 774 7816 13887 14936 23708 31712 33160
88 536 600 1239 1887 12195 13782 16726 27998
151 269 585 1445 3178 3970 15568 20358 21051
650 819 865 15567 18546 25571 32038 33350 33620
93 469 800 6059 10405 12296 17515 21354 22231
97 206 951 6161 16376 27022 29192 30190 30665
412 549 986 5833 10583 10766 24946 28878 31937
72 604 659 5267 12227 21714 32120 33472 33974
25 902 912 1137 2975 9642 11598 25919 28278
420 976 1055 8473 11512 20198 21662 25443 30119
1 24 932 6426 11899 13217 13935 16548 29737
53 618 988 6280 7267 11676 13575 15532 25787
111 739 809 8133 12717 12741 20253 20608 27850
120 683 943 14496 15162 15440 18660 27543 32404
600 754 1055 7873 9679 17351 27268 33508
344 756 1054 7102 7193 22903 24720 27883
582 1003 1046 11344 23756 27497 27977 32853
28 429 509 11106 11767 12729 13100 31792
131 555 907 5113 10259 10300 20580 23029
406 915 977 12244 20259 26616 27899 32228
46 195 224 1229 4116 10263 13608 17830
19 819 953 7965 9988 13959 30580 30754
164 1003 1032 12920 15975 16582 22624 27357
8433 11894 13531 17675 25889 31384
3166 3813 8596 10368 25104 29584
2466 8241 12424 13376 24837 32711

Table A.1.7 Rate = 8/15 ($N_{inner} = 64800$)

2768 3039 4059 5856 6245 7013 8157 9341 9802 10470 11521 12083 16610 18361 20321 24601 27420 28206 29788	5496 15681 21854
2739 8244 8891 9157 12624 12973 15534 16622 16919 18402 18780 19854 20220 20543 22306 25540 27478 27678 28053	12697 13407 22178
1727 2268 6246 7815 9010 9556 10134 10472 11389 14599 15719 16204 17342 17666 18850 22058 25579 25860 29207	12788 21227 22894
28 1346 3721 5565 7019 9240 12355 13109 14800 16040 16839 17369 17631 19357 19473 19891 20381 23911 29683	629 2854 6232
869 2450 4386 5316 6160 7107 10362 11132 11271 13149 16397 16532 17113 19894 22043 22784 27383 28615 28804	2289 18227 27458
508 4292 5831 8559 10044 10412 11283 14810 15888 17243 17538 19903 20528 22090 22652 27235 27384 28208 28485	7593 21935 23001
389 2248 5840 6043 7000 9054 11075 11760 12217 12565 13587 15403 19422 19528 21493 25142 27777 28566 28702	3836 7081 12282
1015 2002 5764 6777 9346 9629 11039 11153 12690 13068 13990 16841 17702 20021 24106 26300 29332 30081 30196	7925 18440 23135
1480 3084 3467 4401 4798 5187 7851 11368 12323 14325 14546 16360 17158 18010 21333 25612 26556 26906 27005	497 6342 9717
6925 8876 12392 14529 15253 15437 19226 19950 20321 23021 23651 24393 24653 26668 27205 28269 28529 29041 29292	11199 22046 30067
2547 3404 3538 4666 5126 5468 7695 8799 14732 15072 15881 17410 18971 19609 19717 22150 24941 27908 29018	12572 28045 28990
888 1581 2311 5511 7218 9107 10454 12252 13662 15714 15894 17025 18671 24304 25316 25556 28489 28977 29212	1240 2023 10933
1047 1494 1718 4645 5030 6811 7868 8146 10611 15767 17682 18391 22614 23021 23763 25478 26491 29088 29757	19566 20629 25186
59 1781 1900 3814 4121 8044 8906 9175 11156 14841 15789 16033 16755 17292 18550 19310 22505 29567 29850	6442 13303 28813
1952 3057 4399 9476 10171 10769 11335 11569 15002 19501 20621 22642 23452 24360 25109 25290 25828 28505 29122	4765 10572 16180
2895 3070 3437 4764 4905 6670 9244 11845 13352 13573 13975 14600 15871 17996 19672 20079 20579 25327 27958	552 19301 24286
612 1528 2004 4244 4599 4926 5843 7684 10122 10443 12267 14368 18413 19058 22985 24257 26202 26596 27899	6782 18480 21383
1361 2195 4146 6708 7158 7538 9138 9998 14862 15359 16076 18925 21401 21573 22503 24146 24247 27778 29312	11267 12288 15758
5229 6235 7134 7655 9139 13527 15408 16058 16705 18320 19909 20901 22238 22437 23654 25131 27550 28247 29903	771 5652 15531
697 2035 4887 5275 6909 9166 11805 15338 16381 18403 20425 20688 21547 24590 25171 26726 28848 29224 29412	16131 20047 25649
5379 17329 22659 23062	13227 23035 24450
11814 14759 22329 22936	4839 13467 27488
2423 2811 10296 12727	2852 4677 22993
8460 15260 16769 17290	2504 28116 29524
14191 14608 29536 30187	12518 17374 24267
7103 10069 20111 22850	1222 11859 27922
4285 15413 26448 29069	9660 17286 18261
548 2137 9189 10928	232 11296 29978
4581 7077 23382 23949	9750 11165 16295
3942 17248 19486 27922	4894 9505 23622
8668 10230 16922 26678	10861 11980 14110
6158 9980 13788 28198	2128 15883 22836
12422 16076 24206 29887	6274 17243 21989
8778 10649 18747 22111	10866 13202 22517
21029 22677 27150 28980	11159 16111 21608
7918 15423 27672 27803	3719 18787 22100
5927 18086 23525	1756 2020 23901
3397 15058 30224	20913 29473 30103
24016 25880 26268	2729 15091 26976
1096 4775 7912	4410 8217 12963
3259 17301 20802	5395 24564 28235
129 8396 15132	3859 17909 23051
17825 28119 28676	5733 26005 29797
2343 8382 28840	1935 3492 29773
3907 18374 20939	11903 21380 29914
1132 1290 8786	6091 10469 29997
1481 4710 28846	2895 8930 15594
2185 3705 26834	1827 10028 20070

Table A.1.8 Rate = 9/15 ($N_{inner} = 64800$)

113 1557 3316 5680 6241 10407 13404 13947 14040 14353 15522 15698 16079 17363 19374 19543 20530 22833 24339	56 4564 19121
271 1361 6236 7006 7307 7333 12768 15441 15568 17923 18341 20321 21502 22023 23938 25351 25590 25876 25910	5595 15086 25892
73 605 872 4008 6279 7653 10346 10799 12482 12935 13604 15909 16526 19782 20506 22804 23629 24859 25600	3174 17127 23183
1445 1690 4304 4851 8919 9176 9252 13783 16076 16675 17274 18806 18882 20819 21958 22451 23869 23999 24177	19397 19817 20275
1290 2337 5661 6371 8996 10102 10941 11360 12242 14918 16808 20571 23374 24046 25045 25060 25662 25783 25913	12561 24571 25825
28 42 1926 3421 3503 8558 9453 10168 15820 17473 19571 19685 22790 23336 23367 23890 24061 25657 25680	7111 9889 25865
0 1709 4041 4932 5968 7123 8430 9564 10596 11026 14761 19484 20762 20858 23803 24016 24795 25853 25863	19104 20189 21851
29 1625 6500 6609 16831 18517 18568 18738 19387 20159 20544 21603 21941 24137 24269 24416 24803 25154 25395	549 9686 25548
55 66 871 3700 11426 13221 15001 16367 17601 18380 22796 23488 23938 25476 25635 25678 25807 25857 25872	6586 20325 25906
1 19 5958 8548 8860 11489 16845 18450 18469 19496 20190 23173 25262 25566 25668 25679 25858 25888 25915	3224 20710 21637
7520 7690 8855 9183 14654 16695 17121 17854 18083 18428 19633 20470 20736 21720 22335 23273 25083 25293 25403	641 15215 25754
48 58 410 1299 3786 10668 18523 18963 20864 22106 22308 23033 23107 23128 23990 24286 24409 24595 25802	13484 23729 25818
12 51 3894 6539 8276 10885 11644 12777 13427 14039 15954 17078 19053 20537 22863 24521 25087 25463 25838	2043 7493 24246
3509 8748 9581 11509 15884 16230 17583 19264 20900 21001 21310 22547 22756 22959 24768 24814 25594 25626 25880	16860 25230 25768
21 29 69 1448 2386 4601 6626 6667 10242 13141 13852 14137 18640 19951 22449 23454 24431 25512 25814	22047 24200 24902
18 53 7890 9934 10063 16728 19040 19809 20825 21522 21800 23582 24556 25031 25547 25562 25733 25789 25906	9391 18040 19499
4096 4582 5766 5894 6517 10027 12182 13247 15207 17041 18958 20133 20503 22228 24332 24613 25689 25855 25883	7855 24336 25069
0 25 819 5539 7076 7536 7695 9532 13668 15051 17683 19665 20253 21996 24136 24890 25758 25784 25807	23834 25570 25852
34 40 44 4215 6076 7427 7965 8777 11017 15593 19542 22202 22973 23397 23423 24418 24873 25107 25644	1977 8800 25756
1595 6216 22850 25439	6671 21772 25859
1562 15172 19517 22362	3279 6710 24444
7508 12879 24324 24496	24099 25117 25820
6298 15819 16757 18721	5553 12306 25915
11173 15175 19966 21195	48 11107 23907
59 13505 16941 23793	10832 11974 25773
2267 4830 12023 20587	2223 17905 25484
8827 9278 13072 16664	16782 17135 20446
14419 17463 23398 25348	475 2861 3457
6112 16534 20423 22698	16218 22449 24362
493 8914 21103 24799	11716 22200 25897
6896 12761 13206 25873	8315 15009 22633
2 1380 12322 21701	13 20480 25852
11600 21306 25753 25790	12352 18658 25687
8421 13076 14271 15401	3681 14794 23703
9630 14112 19017 20955	30 24531 25846
212 13932 21781 25824	4103 22077 24107
5961 9110 16654 19636	23837 25622 25812
58 5434 9936 12770	3627 13387 25839
6575 11433 19798	908 5367 19388
2731 7338 20926	0 6894 25795
14253 18463 25404	20322 23546 25181
21791 24805 25869	8178 25260 25437
2 11646 15850	2449 13244 22565
6075 8586 23819	31 18928 22741
18435 22093 24852	1312 5134 14838
2103 2368 11704	6085 13937 24220
10925 17402 18232	66 14633 25670
9062 25061 25674	47 22512 25472
18497 20853 23404	8867 24704 25279
18606 19364 19551	6742 21623 22745
7 1022 25543	147 9948 24178
6744 15481 25868	8522 24261 24307
9081 17305 25164	19202 22406 24609
8 23701 25883	
9680 19955 22848	

Table A.1.9 Rate = 10/15 ($N_{inner} = 64800$)

316 1271 3692 9495 12147 12849 14928 16671 16938 17864 19108 20502 21097 21115	615 1249 4639
2341 2559 2643 2816 2865 5137 5331 7000 7523 8023 10439 10797 13208 15041	3821 12073 18506
5556 6858 7677 10162 10207 11349 12321 12398 14787 15743 15859 15952 19313 20879	1066 16522 21536
349 573 910 2702 3654 6214 9246 9353 10638 11772 14447 14953 16620 19888	11307 18363 19740
204 1390 2887 3835 6230 6533 7443 7876 9299 10291 10896 13960 18287 20086	3240 8560 10391
541 2429 2838 7144 8523 8637 10490 10585 11074 12074 15762 16812 17900 18548	3124 11424 20779
733 1659 3838 5323 5805 7882 9429 10682 13697 16909 18846 19587 19592 20904	1604 8861 17394
1134 2136 4631 4653 4718 5197 10410 11666 14996 15305 16048 17417 18960 20303	2083 7400 8093
734 1001 1283 4959 10016 10176 10973 11578 12051 15550 15915 19022 19430 20121	3218 7454 9155
745 4057 5855 9885 10594 10989 13156 13219 13351 13631 13685 14577 17713 20386	9855 15998 20533
968 1446 2130 2502 3092 3787 5323 8104 8418 9998 11681 13972 17747 17929	316 2850 20652
3020 3857 5275 5786 6319 8608 11943 14062 17144 17752 18001 18453 19311 21414	5583 9768 10333
709 747 1038 2181 5320 8292 10584 10859 13964 15009 15277 16953 20675 21509	7147 7713 18339
1663 3247 5003 5760 7186 7360 10346 14211 14717 14792 15155 16128 17355 17970	12607 17428 21418
516 578 1914 6147 9419 11148 11434 13289 13325 13332 19106 19257 20962 21556	14216 16954 18164
5009 5632 6531 9430 9886 10621 11765 13969 16178 16413 18110 18249 20616 20759	8477 15970 18488
457 2686 3318 4608 5620 5858 6480 7430 9602 12691 14664 18777 20152 20848	1632 8032 9751
33 2877 5334 6851 7907 8654 10688 15401 16123 17942 17969 18747 18931 20224	4573 9080 13507
87 897 7636 8663 11425 12288 12672 14199 16435 17615 17950 18953 19667 20281	11747 12441 13876
1042 1832 2545 2719 2947 3672 3700 6249 6398 6833 11114 14283 17694 20477	1183 15605 16675
326 488 2662 2880 3009 5357 6587 8882 11604 14374 18781 19051 19057 20508	4408 10264 17109
854 1294 2436 2852 4903 6466 7761 9072 9564 10321 13638 15658 16946 19119	5495 7882 12150
194 899 1711 2408 2786 5391 7108 8079 8716 11453 17303 19484 20989 21389	1010 3763 5065
1631 3121 3994 5005 7810 8850 10315 10589 13407 17162 18624 18758 19311 20301	9828 18054 21599
736 2424 4792 5600 6370 10061 16053 16775 18600	6342 7353 15358
1254 8163 8876 9157 12141 14587 16545 17175 18191	6362 9462 19999
388 6641 8974 10607 10716 14477 16825 17191 18400	7184 13693 17622
5578 6082 6824 7360 7745 8655 11402 11665 12428	4343 4654 10995
3603 8729 13463 14698 15210 19112 19550 20727 21052	7099 8466 18520
48 1732 3805 5158 15442 16909 19854 21071 21579	11505 14395 15138
11707 14014 21531	6779 16691 18726
1542 4133 4925	7146 12644 20196
10083 13505 21198	5865 16728 19634
14300 15765 16752	4657 8714 21246
778 1237 11215	4580 5279 18750
1325 3199 14534	3767 6620 18905
2007 14510 20599	9209 13093 17575
1996 5881 16429	12486 15875 19791
5111 15018 15980	8046 14636 17491
4989 10681 12810	2120 4643 13206
3763 10715 16515	6186 9675 12601
2259 10080 15642	784 5770 21585
9032 11319 21305	
3915 15213 20884	
11150 15022 20201	
1147 6749 19625	
12139 12939 18870	
3840 4634 10244	
1018 10231 17720	
2708 13056 13393	
5781 11588 18888	
1345 2036 5252	
5908 8143 15141	
1804 13693 18640	
10433 13965 16950	
9568 10122 15945	
547 6722 14015	
321 12844 14095	
2632 10513 14936	
6369 11995 20321	
9920 19136 21529	
1990 2726 10183	
5763 12118 15467	
503 10006 19564	
9839 11942 19472	
11205 13552 15389	
8841 13797 19697	
124 6053 18224	
6477 14406 21146	
1224 8027 16011	
3046 4422 17717	
739 12308 17760	
4014 4130 7835	
2266 5652 11981	
2711 7970 18317	
2196 15229 17217	
8636 13302 16764	
5612 15010 16657	

Table A.1.10 Rate = 11/15 ($N_{inner} = 64800$)

696 989 1238 3091 3116 3738 4269 6406 7033 8048 9157 10254 12033 16456 16912	16936 17122 17162
444 1488 6541 8626 10735 12447 13111 13706 14135 15195 15947 16453 16916 17137 17268	4868 8451 13183
401 460 992 1145 1576 1678 2238 2320 4280 6770 10027 12486 15363 16714 17157	3714 4451 16919
1161 3108 3727 4508 5092 5348 5582 7727 11793 12515 12917 13362 14247 16717 17205	11313 13801 17132
542 1190 6883 7911 8349 8835 10489 11631 14195 15009 15454 15482 16632 17040 17063	17070 17191 17242
17 487 776 880 5077 6172 9771 11446 12798 16016 16109 16171 17087 17132 17226	1911 11201 17186
1337 3275 3462 4229 9246 10180 10845 10866 12250 13633 14482 16024 16812 17186 17241	14 17190 17254
15 980 2305 3674 5971 8224 11499 11752 11770 12897 14082 14836 15311 16391 17209	11760 16008 16832
0 3926 5869 8696 9351 9391 11371 14052 14172 14636 14974 16619 16961 17033 17237	14543 17033 17278
3033 5317 6501 8579 10698 12168 12966 14019 15392 15806 15991 16493 16690 17062 17090	16129 16765 17155
981 1205 4400 6410 11003 13319 13405 14695 15846 16297 16492 16563 16616 16862 16953	6891 15561 17007
1725 4276 8869 9588 14062 14486 15474 15548 16300 16432 17042 17050 17060 17175 17273	12741 14744 17116
1807 5921 9960 10011 14305 14490 14872 15852 16054 16061 16306 16799 16833 17136 17262	8992 16661 17277
2826 4752 6017 6540 7016 8201 14245 14419 14716 15983 16569 16652 17171 17179 17247	1861 11130 16742
1662 2516 3345 5229 8086 9686 11456 12210 14595 15808 16011 16421 16825 17112 17195	4822 13331 16192
2890 4821 5987 7226 8823 9869 12468 14694 15352 15805 16075 16462 17102 17251 17263	13281 14027 14989
3751 3890 4382 5720 10281 10411 11350 12721 13121 14127 14980 15202 15335 16735 17123	38 14887 17141
26 30 2805 5457 6630 7188 7477 7556 11065 16608 16859 16909 16943 17030 17103	10698 13452 15674
40 4524 5043 5566 9645 10204 10282 11696 13080 14837 15607 16274 17034 17225 17266	4 2539 16877
904 3157 6284 7151 7984 11712 12887 13767 15547 16099 16753 16829 17044 17250 17259	857 17170 17249
7 311 4876 8334 9249 11267 14072 14559 15003 15235 15686 16331 17177 17238 17253	11449 11906 12867
4410 8066 8596 9631 10369 11249 12610 15769 16791 16960 17018 17037 17062 17165 17204	285 14118 16831
24 8261 9691 10138 11607 12782 12786 13424 13933 15262 15795 16476 17084 17193 17220	15191 17214 17242
88 11622 14705 15890	39 728 16915
304 2026 2638 6018	2469 12969 15579
1163 4268 11620 17232	16644 17151 17164
9701 11785 14463 17260	2592 8280 10448
4118 10952 12224 17006	9236 12431 17173
3647 10823 11521 12060	9064 16892 17233
1717 3753 9199 11642	4526 16146 17038
2187 14280 17220	31 2116 16083
14787 16903 17061	15837 16951 17031
381 3534 4294	5362 8382 16618
3149 6947 8323	6137 13199 17221
12562 16724 16881	2841 15068 17068
7289 9997 15306	24 3620 17003
5615 13152 17260	9880 15718 16764
5666 16926 17027	1784 10240 17209
4190 7798 16831	2731 10293 10846
4778 10629 17180	3121 8723 16598
10001 13884 15453	8563 15662 17088
6 2237 8203	13 1167 14676
7831 15144 15160	29 13850 15963
9186 17204 17243	3654 7553 8114
9435 17168 17237	23 4362 14865
42 5701 17159	4434 14741 16688
7812 14259 15715	8362 13901 17244
39 4513 6658	13687 16736 17232
38 9368 11273	46 4229 13394
1119 4785 17182	13169 16383 16972
5620 16521 16729	16031 16681 16952
16 6685 17242	3384 9894 12580
210 3452 12383	9841 14414 16165
466 14462 16250	5013 17099 17115
10548 12633 13962	2130 8941 17266
1452 6005 16453	6907 15428 17241
22 4120 13684	16 1860 17235
5195 11563 16522	2151 16014 16643
5518 16705 17201	14954 15958 17222
12233 14552 15471	3969 8419 15116
6067 13440 17248	31 15593 16984
8660 8967 17061	11514 16605 17255
8673 12176 15051	
5959 15767 16541	
3244 12109 12414	
31 15913 16323	
3270 15686 16653	
24 7346 14675	
12 1531 8740	
6228 7565 16667	

Table A.1.11 Rate = 12/15 ($N_{inner} = 64800$)

584 1472 1621 1867 3338 3568 3723 4185 5126 5889 7737 8632 8940 9725	4023 6108 6911
221 445 590 3779 3835 6939 7743 8280 8448 8491 9367 10042 11242 12917	8621 10184 11650
4662 4837 4900 5029 6449 6687 6751 8684 9936 11681 11811 11886 12089 12909	6726 10861 12348
2418 3018 3647 4210 4473 7447 7502 9490 10067 11092 11139 11256 12201 12383	3228 6302 7388
2591 2947 3349 3406 4417 4519 5176 6672 8498 8863 9201 11294 11376 12184	1 1137 5358
27 101 197 290 871 1727 3911 5411 6676 8701 9350 10310 10798 12439	381 2424 8537
1765 1897 2923 3584 3901 4048 6963 7054 7132 9165 10184 10824 11278 12669	3256 7508 10044
2183 3740 4808 5217 5660 6375 6787 8219 8466 9037 10353 10583 11118 12762	1980 2219 4569
73 1594 2146 2715 3501 3572 3639 3725 6959 7187 8406 10120 10507 10691	2468 5699 10319
240 732 1215 2185 2788 2830 3499 3881 4197 4991 6425 7061 9756 10491	2803 3314 12808
831 1568 1828 3424 4319 4516 4639 6018 9702 10203 10417 11240 11518 12458	8578 9642 11533
2024 2970 3048 3638 3676 4152 5284 5779 5926 9426 9945 10873 11787 11837	829 4585 7923
1049 1218 1651 2328 3493 4363 5750 6483 7613 8782 9738 9803 11744 11937	59 329 5575
1193 2060 2289 2964 3478 4592 4756 6709 7162 8231 8326 11140 11908 12243	1067 5709 6867
978 2120 2439 3338 3850 4589 6567 8745 9656 9708 10161 10542 10711 12639	1175 4744 12219
2403 2938 3117 3247 3711 5593 5844 5932 7801 10152 10226 11498 12162 12941	109 2518 6756
1781 2229 2276 2533 3582 3951 5279 5774 7930 9824 10920 11038 12340 12440	2105 10626 11153
289 384 1980 2230 3464 3873 5958 8656 8942 9006 10175 11425 11745 12530	5192 10696 10749
155 354 1090 1330 2002 2236 3559 3705 4922 5958 6576 8564 9972 12760	6260 7641 8233
303 876 2059 2142 5244 5330 6644 7576 8614 9598 10410 10718 11033 12957	2998 3094 11214
3449 3617 4408 4602 4727 6182 8835 8928 9372 9644 10237 10747 11655 12747	3398 6466 11494
811 2565 2820 8677 8974 9632 11069 11548 11839 12107 12411 12695 12812 12890	6574 10448 12160
972 4123 4943 6385 6449 7339 7477 8379 9177 9359 10074 11709 12552 12831	2734 10755 12831
842 973 1541 2262 2905 5276 6758 7099 7894 8128 8325 8663 8875 10050	1028 7958 10825
474 791 968 3902 4924 4965 5085 5908 6109 6329 7931 9038 9401 10568	8545 8602 10793
1397 4461 4658 5911 6037 7127 7318 8678 8924 9000 9473 9602 10446 12692	392 3398 11417
1334 7571 12881	6639 9291 12571
1393 1447 7972	1067 7919 8934
633 1257 10597	1064 2848 12753
4843 5102 11056	6076 8656 12690
3294 8015 10513	5504 6193 10171
1108 10374 10546	1951 7156 7356
5353 7824 10111	4389 4780 7889
3398 7674 8569	526 4804 9141
7719 9478 10503	1238 3648 10464
2997 9418 9581	2587 5624 12557
5777 6519 11229	5560 5903 11963
1966 5214 9899	1134 2570 3297
6 4088 5827	10041 11583 12157
836 9248 9612	1263 9585 12912
483 7229 7548	3744 7898 10646
7865 8289 9804	45 9074 10315
2915 11098 11900	1051 6188 10038
6180 7096 9481	2242 8394 12712
1431 6786 8924	3598 9025 12651
748 6757 8625	2295 3540 5610
3312 4475 7204	1914 4378 12423
1852 8958 11020	1766 3635 12759
1915 2903 4006	5177 9586 11143
6776 10886 12531	943 3590 11649
2594 9998 12742	4864 6905 10454
159 2002 12079	5852 6042 10421
853 3281 3762	6095 8285 12349
5201 5798 6413	2070 7171 8563
3882 6062 12047	718 12234 12716
4133 6775 9657	512 10667 11353
228 6874 11183	3629 6485 7040
7433 10728 10864	2880 8865 11466
7735 8073 12734	4490 10220 11796
2844 4621 11779	5440 8819 9103
3909 7103 12804	5262 7543 12411
6002 9704 11060	516 7779 10940
5864 6856 7681	2515 5843 9202
3652 5869 7605	4684 5994 10586
2546 2657 4461	573 2270 3324
2423 4203 9111	7870 8317 10322
244 1855 4691	6856 7638 12909
1106 2178 6371	1583 7669 10781
391 1617 10126	8141 9085 12555
250 9259 10603	3903 5485 9992
3435 4614 6924	4467 11998 12904
1742 8045 9529	
7667 8875 11451	

Table A.1.12 Rate = 13/15 ($N_{inner} = 64800$)

142 2307 2598 2650 4028 4434 5781 5881 6016 6323 6681 6698 8125	1704 2480 4181
2932 4928 5248 5256 5983 6773 6828 7789 8426 8494 8534 8539 8583	7338 7929 7990
899 3295 3833 5399 6820 7400 7753 7890 8109 8451 8529 8564 8602	2615 3905 7981
21 3060 4720 5429 5636 5927 6966 8110 8170 8247 8355 8365 8616	4298 4548 8296
20 1745 2838 3799 4380 4418 4646 5059 7343 8161 8302 8456 8631	8262 8319 8630
9 6274 6725 6792 7195 7333 8027 8186 8209 8273 8442 8548 8632	892 1893 8028
494 1365 2405 3799 5188 5291 7644 7926 8139 8458 8504 8594 8625	5694 7237 8595
192 574 1179 4387 4695 5089 5831 7673 7789 8298 8301 8612 8632	1487 5012 5810
11 20 1406 6111 6176 6256 6708 6834 7828 8232 8457 8495 8602	4335 8593 8624
6 2654 3554 4483 4966 5866 6795 8069 8249 8301 8497 8509 8623	3509 4531 5273
21 1144 2355 3124 6773 6805 6887 7742 7994 8358 8374 8580 8611	10 22 830
335 4473 4883 5528 6096 7543 7586 7921 8197 8319 8394 8489 8636	4161 5208 6280
2919 4331 4419 4735 6366 6393 6844 7193 8165 8205 8544 8586 8617	275 7063 8634
12 19 742 930 3009 4330 6213 6224 7292 7430 7792 7922 8137	4 2725 3113
710 1439 1588 2434 3516 5239 6248 6827 8230 8448 8515 8581 8619	2279 7403 8174
200 1075 1868 5581 7349 7642 7698 8037 8201 8210 8320 8391 8526	1637 3328 3930
3 2501 4252 5256 5292 5567 6136 6321 6430 6486 7571 8521 8636	2810 4939 5624
3062 4599 5885 6529 6616 7314 7319 7567 8024 8153 8302 8372 8598	3 1234 7687
105 381 1574 4351 5452 5603 5943 7467 7788 7933 8362 8513 8587	2799 7740 8616
787 1857 3386 3659 6550 7131 7965 8015 8040 8312 8484 8525 8537	22 7701 8636
15 1118 4226 5197 5575 5761 6762 7038 8260 8338 8444 8512 8568	4302 7857 7993
36 5216 5368 5616 6029 6591 8038 8067 8299 8351 8565 8578 8585	7477 7794 8592
1 23 4300 4530 5426 5532 5817 6967 7124 7979 8022 8270 8437	9 6111 8591
629 2133 4828 5475 5875 5890 7194 8042 8345 8385 8518 8598 8612	5 8606 8628
11 1065 3782 4237 4993 7104 7863 7904 8104 8228 8321 8383 8565	347 3497 4033
2131 2274 3168 3215 3220 5597 6347 7812 8238 8354 8527 8557 8614	1747 2613 8636
5600 6591 7491 7696	1827 5600 7042
1766 8281 8626	580 1822 6842
1725 2280 5120	232 7134 7783
1650 3445 7652	4629 5000 7231
4312 6911 8626	951 2806 4947
15 1013 5892	571 3474 8577
2263 2546 2979	2437 2496 7945
1545 5873 7406	23 5873 8162
67 726 3697	12 1168 7686
2860 6443 8542	8315 8540 8596
17 911 2820	1766 2506 4733
1561 4580 6052	929 1516 3338
79 5269 7134	21 1216 6555
22 2410 2424	782 1452 8617
3501 5642 8627	8 6083 6087
808 6950 8571	667 3240 4583
4099 6389 7482	4030 4661 5790
4023 5000 7833	559 7122 8553
5476 5765 7917	3202 4388 4909
1008 3194 7207	2533 3673 8594
20 495 5411	1991 3954 6206
1703 8388 8635	6835 7900 7980
6 4395 4921	189 5722 8573
200 2053 8206	2680 4928 4998
1089 5126 5562	243 2579 7735
10 4193 7720	4281 8132 8566
1967 2151 4608	7656 7671 8609
22 738 3513	1116 2291 4166
3385 5066 8152	21 388 8021
440 1118 8537	6 1123 8369
3429 6058 7716	311 4918 8511
5213 7519 8382	0 3248 6290
5564 8365 8620	13 6762 7172
43 3219 8603	4209 5632 7563
4 5409 5815	49 127 8074
5 6376 7654	581 1735 4075
4091 5724 5953	0 2235 5470
5348 6754 8613	2178 5820 6179
1634 6398 6632	16 3575 6054
72 2058 8605	1095 4564 6458
3497 5811 7579	9 1581 5953
3846 6743 8559	2537 6469 8552
15 5933 8629	14 3874 4844
2133 5859 7068	0 3269 3551
4151 4617 8566	2114 7372 7926
2960 8270 8410	1875 2388 4057
2059 3617 8210	3232 4042 6663
544 1441 6895	9 401 583
4043 7482 8592	13 4100 6584
294 2180 8524	2299 4190 4410
3058 8227 8373	21 3670 4979
364 5756 8617	
5383 8555 8619	

A.2 LDPC CODE MATRICES ($N_{INNER} = 16200$)**Table A.2.1** Rate = 2/15 ($N_{inner} = 16200$)

2889 3122 3208 4324 5968 7241 13215
 281 923 1077 5252 6099 10309 11114
 727 2413 2676 6151 6796 8945 12528
 2252 2322 3093 3329 8443 12170 13748
 575 2489 2944 6577 8772 11253 11657
 310 1461 2482 4643 4780 6936 11970
 8691 9746 10794 13582
 3717 6535 12470 12752
 6011 6547 7020 11746
 5309 6481 10244 13824
 5327 8773 8824 13343
 3506 3575 9915 13609
 3393 7089 11048 12816
 3651 4902 6118 12048
 4210 10132 13375 13377

Table A.2.2 Rate = 3/15 ($N_{inner} = 16200$)

8 372 841 4522 5253 7430 8542 9822 10550 11896 11988
 80 255 667 1511 3549 5239 5422 5497 7157 7854 11267
 257 406 792 2916 3072 3214 3638 4090 8175 8892 9003
 80 150 346 1883 6838 7818 9482 10366 10514 11468 12341
 32 100 978 3493 6751 7787 8496 10170 10318 10451 12561
 504 803 856 2048 6775 7631 8110 8221 8371 9443 10990
 152 283 696 1164 4514 4649 7260 7370 11925 11986 12092
 127 1034 1044 1842 3184 3397 5931 7577 11898 12339 12689
 107 513 979 3934 4374 4658 7286 7809 8830 10804 10893
 2045 2499 7197 8887 9420 9922 10132 10540 10816 11876
 2932 6241 7136 7835 8541 9403 9817 11679 12377 12810
 2211 2288 3937 4310 5952 6597 9692 10445 11064 11272

Table A.2.3 Rate = 4/15 ($N_{inner} = 16200$)

19 585 710 3241 3276 3648 6345 9224 9890 10841
 181 494 894 2562 3201 4382 5130 5308 6493 10135
 150 569 919 1427 2347 4475 7857 8904 9903
 1005 1018 1025 2933 3280 3946 4049 4166 5209
 420 554 778 6908 7959 8344 8462 10912 11099
 231 506 859 4478 4957 7664 7731 7908 8980
 179 537 979 3717 5092 6315 6883 9353 9935
 147 205 830 3609 3720 4667 7441 10196 11809
 60 1021 1061 1554 4918 5690 6184 7986 11296
 145 719 768 2290 2919 7272 8561 9145 10233
 388 590 852 1579 1698 1974 9747 10192 10255
 231 343 485 1546 3155 4829 7710 10394 11336
 4381 5398 5987 9123 10365 11018 11153
 2381 5196 6613 6844 7357 8732 11082
 1730 4599 5693 6318 7626 9231 10663

Table A.2.4 Rate = 5/15 ($N_{inner} = 16200$)

69 244 706 5145 5994 6066 6763 6815 8509
 257 541 618 3933 6188 7048 7484 8424 9104
 69 500 536 1494 1669 7075 7553 8202 10305
 11 189 340 2103 3199 6775 7471 7918 10530
 333 400 434 1806 3264 5693 8534 9274 10344
 111 129 260 3562 3676 3680 3809 5169 7308 8280
 100 303 342 3133 3952 4226 4713 5053 5717 9931
 83 87 374 828 2460 4943 6311 8657 9272 9571
 114 166 325 2680 4698 7703 7886 8791 9978 10684
 281 542 549 1671 3178 3955 7153 7432 9052 10219
 202 271 608 3860 4173 4203 5169 6871 8113 9757
 16 359 419 3333 4198 4737 6170 7987 9573 10095
 235 244 584 4640 5007 5563 6029 6816 7678 9968
 123 449 646 2460 3845 4161 6610 7245 7686 8651
 136 231 468 835 2622 3292 5158 5294 6584 9926
 3085 4683 8191 9027 9922 9928 10550
 2462 3185 3976 4091 8089 8772 9342

Table A.2.5 Rate = 6/15 ($N_{inner} = 16200$)

27 430 519 828 1897 1943 2513 2600 2640 3310 3415 4266 5044 5100 5328 5483 5928 6204 6392 6416 6602 7019 7415 7623 8112 8485 8724 8994 9445 9667
 27 174 188 631 1172 1427 1779 2217 2270 2601 2813 3196 3582 3895 3908 3948 4463 4955 5120 5809 5988 6478 6604 7096 7673 7735 7795 8925 9613 9670
 27 370 617 852 910 1030 1326 1521 1606 2118 2248 2909 3214 3413 3623 3742 3752 4317 4694 5300 5687 6039 6100 6232 6491 6621 6860 7304 8542 8634
 990 1753 7635 8540
 933 1415 5666 8745
 27 6567 8707 9216
 2341 8692 9580 9615
 260 1092 5839 6080
 352 3750 4847 7726
 4610 6580 9506 9597
 2512 2974 4814 9348
 1461 4021 5060 7009
 1796 2883 5553 8306
 1249 5422 7057
 3965 6968 9422
 1498 2931 5092
 27 1090 6215
 26 4232 6354

Table A.2.6 Rate = 7/15 ($N_{inner} = 16200$)

553 742 901 1327 1544 2179 2519 3131 3280 3603 3789 3792 4253 5340 5934 5962 6004 6698 7793 8001 8058 8126 8276 8559
 503 590 598 1185 1266 1336 1806 2473 3021 3356 3490 3680 3936 4501 4659 5891 6132 6340 6602 7447 8007 8045 8059 8249
 795 831 947 1330 1502 2041 2328 2513 2814 2829 4048 4802 6044 6109 6461 6777 6800 7099 7126 8095 8428 8519 8556 8610
 601 787 899 1757 2259 2518 2783 2816 2823 2949 3396 4330 4494 4684 4700 4837 4881 4975 5130 5464 6554 6912 7094 8297
 4229 5628 7917 7992
 1506 3374 4174 5547
 4275 5650 8208 8533
 1504 1747 3433 6345
 3659 6955 7575 7852
 607 3002 4913 6453
 3533 6860 7895 8048
 4094 6366 8314
 2206 4513 5411
 32 3882 5149
 389 3121 4626
 1308 4419 6520
 2092 2373 6849
 1815 3679 7152
 3582 3979 6948
 1049 2135 3754
 2276 4442 6591

Table A.2.7 Rate = 8/15 ($N_{inner} = 16200$)

5 159 825 1871 2098 2478 2659 2820 3200 3294 3650 3804 3949 4426 4460 4503 4568 4590 4949 5219 5662 5738 5905 5911 6160 6404 6637 6708 6737 6814 7263 7412
 81 391 1272 1633 2062 2882 3443 3503 3535 3908 4033 4163 4490 4929 5262 5399 5576 5768 5910 6331 6430 6844 6867 7201 7274 7290 7343 7350 7378 7387 7440 7554
 105 975 3421 3480 4120 4444 5957 5971 6119 6617 6761 6810 7067 7353
 6 138 485 1444 1512 2615 2990 3109 5604 6435 6513 6632 6704 7507
 20 858 1051 2539 3049 5162 5308 6158 6391 6604 6744 7071 7195 7238
 1140 5838 6203 6748
 6282 6466 6481 6638
 2346 2592 5436 7487
 2219 3897 5896 7528
 2897 6028 7018
 1285 1863 5324
 3075 6005 6466
 5 6020 7551
 2121 3751 7507
 4027 5488 7542
 2 6012 7011
 3823 5531 5687
 1379 2262 5297
 1882 7498 7551
 3749 4806 7227
 2 2074 6898
 17 616 7482
 9 6823 7480
 5195 5880 7559

Table A.2.8 Rate = 9/15 ($N_{inner} = 16200$)

212 255 540 967 1033 1517 1538 3124 3408 3800 4373 4864 4905 5163 5177 6186	300 1748 6245
275 660 1351 2211 2876 3063 3433 4088 4273 4544 4618 4632 5548 6101 6111 6136	2724 3276 5349
279 335 494 865 1662 1681 3414 3775 4252 4595 5272 5471 5796 5907 5986 6008	1433 6117 6448
345 352 3094 3188 4297 4338 4490 4865 5303 6477	485 663 4955
222 681 1218 3169 3850 4878 4954 5666 6001 6237	711 1132 4315
172 512 1536 1559 2179 2227 3334 4049 6464	177 3266 4339
716 934 1694 2890 3276 3608 4332 4468 5945	1171 4841 4982
1133 1593 1825 2571 3017 4251 5221 5639 5845	33 1584 3692
1076 1222 6465	2820 3485 4249
159 5064 6078	1716 2428 3125
374 4073 5357	250 2275 6338
2833 5526 5845	108 1719 4961
1594 3639 5419	
1028 1392 4239	
115 622 2175	

Table A.2.9 Rate = 10/15 ($N_{inner} = 16200$)

352 747 894 1437 1688 1807 1883 2119 2159 3321 3400 3543 3588 3770 3821 4384 4470 4884 5012 5036 5084 5101 5271 5281 5353
 505 915 1156 1269 1518 1650 2153 2256 2344 2465 2509 2867 2875 3007 3254 3519 3687 4331 4439 4532 4940 5011 5076 5113 5367
 268 346 650 919 1260 4389 4653 4721 4838 5054 5157 5162 5275 5362
 220 236 828 1590 1792 3259 3647 4276 4281 4325 4963 4974 5003 5037
 381 737 1099 1409 2364 2955 3228 3341 3473 3985 4257 4730 5173 5242
 88 771 1640 1737 1803 2408 2575 2974 3167 3464 3780 4501 4901 5047
 749 1502 2201 3189
 2873 3245 3427
 2158 2605 3165
 1 3438 3606
 10 3019 5221
 371 2901 2923
 9 3935 4683
 1937 3502 3735
 507 3128 4994
 25 3854 4550
 1178 4737 5366
 2 223 5304
 1146 5175 5197
 1816 2313 3649
 740 1951 3844
 1320 3703 4791
 1754 2905 4058
 7 917 5277
 3048 3954 5396
 4804 4824 5105
 2812 3895 5226
 0 5318 5358
 1483 2324 4826
 2266 4752 5387

Table A.2.10 Rate = 11/15 ($N_{inner} = 16200$)

49 719 784 794 968 2382 2685 2873 2974 2995 3540 4179	2732 4132 4318
272 281 374 1279 2034 2067 2112 3429 3613 3815 3838 4216	225 2335 3497
206 714 820 1800 1925 2147 2168 2769 2806 3253 3415 4311	600 2246 2658
62 159 166 605 1496 1711 2652 3016 3347 3517 3654 4113	1240 2790 3020
363 733 1118 2062 2613 2736 3143 3427 3664 4100 4157 4314	301 1097 3539
57 142 436 983 1364 2105 2113 3074 3639 3835 4164 4242	1222 1267 2594
870 921 950 1212 1861 2128 2707 2993 3730 3968 3983 4227	1364 2004 3603
185 2684 3263	1142 1185 2147
2035 2123 2913	564 1505 2086
883 2221 3521	697 991 2908
1344 1773 4132	1467 2073 3462
438 3178 3650	2574 2818 3637
543 756 1639	748 2577 2772
1057 2337 2898	1151 1419 4129
171 3298 3929	164 1238 3401
1626 2960 3503	
484 3050 3323	
2283 2336 4189	

Table A.2.11 Rate = 12/15 ($N_{inner} = 16200$)

3 394 1014 1214 1361 1477 1534 1660 1856 2745 2987 2991 3124 3155	1113 3007 3239
59 136 528 781 803 928 1293 1489 1944 2041 2200 2613 2690 2847	1753 2478 3127
155 245 311 621 1114 1269 1281 1783 1995 2047 2672 2803 2885 3014	0 509 1811
79 870 974 1326 1449 1531 2077 2317 2467 2627 2811 3083 3101 3132	1672 2646 2984
4 582 660 902 1048 1482 1697 1744 1928 2628 2699 2728 3045 3104	965 1462 3230
175 395 429 1027 1061 1068 1154 1168 1175 2147 2359 2376 2613 2682	3 1077 2917
1388 2241 3118 3148	1183 1316 1662
143 506 2067 3148	968 1593 3239
1594 2217 2705	64 1996 2226
398 988 2551	1442 2058 3181
1149 2588 2654	513 973 1058
678 2844 3115	1263 3185 3229
1508 1547 1954	681 1394 3017
1199 1267 1710	419 2853 3217
2589 3163 3207	3 2404 3175
1 2583 2974	2417 2792 2854
2766 2897 3166	1879 2940 3235
929 1823 2742	647 1704 3060

Table A.2.12 Rate = 13/15 ($N_{inner} = 16200$)

71 334 645 779 786 1124 1131 1267 1379 1554 1766 1798 1939	401 465 1040
6 183 364 506 512 922 972 981 1039 1121 1537 1840 2111	112 392 621
6 71 153 204 253 268 781 799 873 1118 1194 1661 2036	82 897 1950
6 247 353 581 921 940 1108 1146 1208 1268 1511 1527 1671	887 1962 2125
6 37 466 548 747 1142 1203 1271 1512 1516 1837 1904 2125	793 1088 2159
6 171 863 953 1025 1244 1378 1396 1723 1783 1816 1914 2121	723 919 1139
1268 1360 1647 1769	610 839 1302
6 458 1231 1414	218 1080 1816
183 535 1244 1277	627 1646 1749
107 360 498 1456	496 1165 1741
6 2007 2059 2120	916 1055 1662
1480 1523 1670 1927	182 722 945
139 573 711 1790	5 595 1674
6 1541 1889 2023	
6 374 957 1174	
287 423 872 1285	
6 1809 1918	
65 818 1396	
590 766 2107	
192 814 1843	
775 1163 1256	
42 735 1415	
334 1008 2055	
109 596 1785	
406 534 1852	
684 719 1543	

Annex B: Bit Interleaver Sequences

B.1 PERMUTATION SEQUENCES OF GROUP-WISE INTERLEAVING FOR $N_{INNER} = 64800$ ($N_{GROUP} = 180$)

Table B.1.1 QPSK ($N_{inner} = 64800$)

	Order of Group-Wise Interleaving $\pi(j)$ ($0 \leq j < 180$)																						
	0	1	2	3	4	5	6	7	8	9	10	11	12	13	14	15	16	17	18	19	20	21	22
Code Rate	23	24	25	26	27	28	29	30	31	32	33	34	35	36	37	38	39	40	41	42	43	44	45
	46	47	48	49	50	51	52	53	54	55	56	57	58	59	60	61	62	63	64	65	66	67	68
	69	70	71	72	73	74	75	76	77	78	79	80	81	82	83	84	85	86	87	88	89	90	91
	92	93	94	95	96	97	98	99	100	101	102	103	104	105	106	107	108	109	110	111	112	113	114
	115	116	117	118	119	120	121	122	123	124	125	126	127	128	129	130	131	132	133	134	135	136	137
	138	139	140	141	142	143	144	145	146	147	148	149	150	151	152	153	154	155	156	157	158	159	160
	161	162	163	164	165	166	167	168	169	170	171	172	173	174	175	176	177	178	179				
2/15	70	149	136	153	104	110	134	61	129	126	58	150	177	168	78	71	120	60	155	175	9	161	103
	123	91	173	57	106	143	151	89	86	35	77	133	31	7	23	51	5	121	83	64	176	119	98
	49	130	128	79	162	32	172	87	131	45	114	93	96	39	68	105	85	109	13	33	145	18	12
	54	111	14	156	8	16	73	2	84	47	42	101	63	88	25	52	170	24	69	142	178	20	65
	97	66	80	11	59	19	115	154	26	147	28	50	160	102	55	139	125	116	138	167	53	169	165
	99	159	148	179	0	146	90	6	100	74	117	48	75	135	41	137	76	92	164	113	152	72	36
	3	163	15	46	21	44	108	34	56	140	127	158	94	67	122	1	27	171	30	157	112	81	118
	43	29	124	22	62	37	40	4	107	166	82	95	10	144	141	132	174	38	17				
3/15	75	170	132	174	7	111	30	4	49	133	50	160	92	106	27	126	116	178	41	166	88	84	80
	153	103	51	58	107	167	39	108	24	145	96	74	65	8	40	76	140	44	68	125	119	82	53
	152	102	38	28	86	162	171	61	93	147	117	32	150	26	59	3	148	173	141	130	154	97	33
	172	115	118	127	6	16	0	143	9	100	67	98	110	2	169	47	83	164	155	123	159	42	105
	12	158	81	20	66	57	121	25	1	90	175	35	60	79	87	135	10	139	156	177	77	89	73
	113	52	109	134	36	176	54	69	146	31	15	71	18	95	124	85	14	78	129	161	19	72	13
	122	21	63	137	120	144	91	157	48	34	46	22	29	104	45	56	151	62	43	94	163	99	64
	138	101	23	11	17	136	128	114	112	165	5	142	179	37	70	131	55	168	149				
4/15	141	86	22	20	176	21	37	82	6	122	130	40	62	44	24	117	8	145	36	79	172	149	127
	163	9	160	73	100	16	153	124	110	49	154	152	4	168	54	177	158	113	57	2	102	161	147
	18	103	1	41	104	144	39	105	131	77	69	108	159	61	45	156	0	83	157	119	112	118	92
	109	75	67	142	96	51	139	31	166	179	89	167	23	34	60	93	165	128	90	19	33	70	173
	174	129	55	98	88	97	146	123	84	111	132	71	140	136	10	115	63	46	42	50	138	81	59
	53	15	52	72	164	150	29	17	91	101	14	38	35	66	64	7	125	151	56	126	171	68	121
	28	65	106	78	47	143	12	169	120	27	74	48	133	43	116	137	94	3	25	134	13	107	162
	32	99	85	175	80	170	5	135	178	11	26	76	95	87	155	58	30	148	114				
5/15	39	47	96	176	33	75	165	38	27	58	90	76	17	46	10	91	133	69	171	32	117	78	13
	146	101	36	0	138	25	77	122	49	14	125	140	93	130	2	104	102	128	4	111	151	84	167
	35	127	156	55	82	85	66	114	8	147	115	113	5	31	100	106	48	52	67	107	18	126	112
	50	9	143	28	160	71	79	43	98	86	94	64	3	166	105	103	118	63	51	139	172	141	175
	56	74	95	29	45	129	120	168	92	150	7	162	153	137	108	159	157	173	23	89	132	57	37
	70	134	40	21	149	80	1	121	59	110	142	152	15	154	145	12	170	54	155	99	22	123	72
	177	131	116	44	158	73	11	65	164	119	174	34	83	53	24	42	60	26	161	68	178	41	148
	109	87	144	135	20	62	81	169	124	6	19	30	163	61	179	136	97	16	88				

6/15	0	14	19	21	2	11	22	9	8	7	16	3	26	24	27	80	100	121	107	31	36	42	46
	49	75	93	127	95	119	73	61	63	117	89	99	129	52	111	124	48	122	82	106	91	92	71
	103	102	81	113	101	97	33	115	59	112	90	51	126	85	123	40	83	53	69	70	132	134	136
	138	140	142	144	146	148	150	152	154	156	158	160	162	164	166	168	170	172	174	176	178	4	5
	10	12	20	6	18	13	17	15	1	29	28	23	25	67	116	66	104	44	50	47	84	76	65
	130	56	128	77	39	94	87	120	62	88	74	35	110	131	98	60	37	45	78	125	41	34	118
	38	72	108	58	43	109	57	105	68	86	79	96	32	114	64	55	30	54	133	135	137	139	141
	143	145	147	149	151	153	155	157	159	161	163	165	167	169	171	173	175	177	179				
7/15	152	172	113	167	100	163	159	144	114	47	161	125	99	89	179	123	149	177	1	132	37	26	16
	57	166	81	133	112	33	151	117	83	52	178	85	124	143	28	59	130	31	157	170	44	61	102
	155	111	153	55	54	176	17	68	169	20	104	38	147	7	174	6	90	15	56	120	13	34	48
	122	110	154	76	64	75	84	162	77	103	156	128	150	87	27	42	3	23	96	171	145	91	24
	78	5	69	175	8	29	106	137	131	43	93	160	108	164	12	140	71	63	141	109	129	82	80
	173	105	9	66	65	92	32	41	72	74	4	36	94	67	158	10	88	142	45	126	2	86	118
	73	79	121	148	95	70	51	53	21	115	135	25	168	11	136	18	138	134	119	146	0	97	22
	165	40	19	60	46	14	49	139	58	101	39	116	127	30	98	50	107	35	62				
8/15	0	2	4	6	8	10	12	14	16	18	20	22	24	26	28	30	32	34	36	38	40	42	44
	46	48	50	52	54	56	58	60	62	64	66	68	70	72	74	76	78	80	82	84	86	88	90
	92	94	96	98	100	102	104	106	108	110	112	114	116	118	120	122	124	126	128	130	132	134	136
	138	140	142	144	146	148	150	152	154	156	158	160	162	164	166	168	170	172	174	176	178	1	3
	5	7	9	11	13	15	17	19	21	23	25	27	29	31	33	35	37	39	41	43	45	47	49
	51	53	55	57	59	61	63	65	67	69	71	73	75	77	79	81	83	85	87	89	91	93	95
	97	99	101	103	105	107	109	111	113	115	117	119	121	123	125	127	129	131	133	135	137	139	141
	143	145	147	149	151	153	155	157	159	161	163	165	167	169	171	173	175	177	179				
9/15	0	2	4	6	8	10	12	14	16	18	20	22	24	26	28	30	32	34	36	38	40	42	44
	46	48	50	52	54	56	58	60	62	64	66	68	70	72	74	76	78	80	82	84	86	88	90
	92	94	96	98	100	102	104	106	108	110	112	114	116	118	120	122	124	126	128	130	132	134	136
	138	140	142	144	146	148	150	152	154	156	158	160	162	164	166	168	170	172	174	176	178	1	3
	5	7	9	11	13	15	17	19	21	23	25	27	29	31	33	35	37	39	41	43	45	47	49
	51	53	55	57	59	61	63	65	67	69	71	73	75	77	79	81	83	85	87	89	91	93	95
	97	99	101	103	105	107	109	111	113	115	117	119	121	123	125	127	129	131	133	135	137	139	141
	143	145	147	149	151	153	155	157	159	161	163	165	167	169	171	173	175	177	179				
10/15	0	2	4	6	8	10	12	14	16	18	20	22	24	26	28	30	32	34	36	38	40	42	44
	46	48	50	52	54	56	58	60	62	64	66	68	70	72	74	76	78	80	82	84	86	88	90
	92	94	96	98	100	102	104	106	108	110	112	114	116	118	120	122	124	126	128	130	132	134	136
	138	140	142	144	146	148	150	152	154	156	158	160	162	164	166	168	170	172	174	176	178	1	3
	5	7	9	11	13	15	17	19	21	23	25	27	29	31	33	35	37	39	41	43	45	47	49
	51	53	55	57	59	61	63	65	67	69	71	73	75	77	79	81	83	85	87	89	91	93	95
	97	99	101	103	105	107	109	111	113	115	117	119	121	123	125	127	129	131	133	135	137	139	141
	143	145	147	149	151	153	155	157	159	161	163	165	167	169	171	173	175	177	179				
11/15	0	14	19	21	2	11	22	9	8	7	16	3	26	24	27	80	100	121	107	31	36	42	46
	49	75	93	127	95	119	73	61	63	117	89	99	129	52	111	124	48	122	82	106	91	92	71
	103	102	81	113	101	97	33	115	59	112	90	51	126	85	123	40	83	53	69	70	132	134	136
	138	140	142	144	146	148	150	152	154	156	158	160	162	164	166	168	170	172	174	176	178	4	5
	10	12	20	6	18	13	17	15	1	29	28	23	25	67	116	66	104	44	50	47	84	76	65
	130	56	128	77	39	94	87	120	62	88	74	35	110	131	98	60	37	45	78	125	41	34	118
	38	72	108	58	43	109	57	105	68	86	79	96	32	114	64	55	30	54	133	135	137	139	141
	143	145	147	149	151	153	155	157	159	161	163	165	167	169	171	173	175	177	179				
12/15	0	2	4	6	8	10	12	14	16	18	20	22	24	26	28	30	32	34	36	38	40	42	44
	46	48	50	52	54	56	58	60	62	64	66	68	70	72	74	76	78	80	82	84	86	88	90
	92	94	96	98	100	102	104	106	108	110	112	114	116	118	120	122	124	126	128	130	132	134	136
	138	140	142	144	146	148	150	152	154	156	158	160	162	164	166	168	170	172	174	176	178	1	3
	5	7	9	11	13	15	17	19	21	23	25	27	29	31	33	35	37	39	41	43	45	47	49
	51	53	55	57	59	61	63	65	67	69	71	73	75	77	79	81	83	85	87	89	91	93	95
	97	99	101	103	105	107	109	111	113	115	117	119	121	123	125	127	129	131	133	135	137	139	141
	143	145	147	149	151	153	155	157	159	161	163	165	167	169	171	173	175	177	179				

13/15	0	2	4	6	8	10	12	14	16	18	20	22	24	26	28	30	32	34	36	38	40	42	44
	46	48	50	52	54	56	58	60	62	64	66	68	70	72	74	76	78	80	82	84	86	88	90
	92	94	96	98	100	102	104	106	108	110	112	114	116	118	120	122	124	126	128	130	132	134	136
	138	140	142	144	146	148	150	152	154	156	158	160	162	164	166	168	170	172	174	176	178	1	3
	5	7	9	11	13	15	17	19	21	23	25	27	29	31	33	35	37	39	41	43	45	47	49
	51	53	55	57	59	61	63	65	67	69	71	73	75	77	79	81	83	85	87	89	91	93	95
	97	99	101	103	105	107	109	111	113	115	117	119	121	123	125	127	129	131	133	135	137	139	141
	143	145	147	149	151	153	155	157	159	161	163	165	167	169	171	173	175	177	179				

Table B.1.2 16QAM ($N_{inner} = 64800$)

Code Rate	Order of Group-Wise Interleaving $\pi(j)$ ($0 \leq j < 180$)																						
	0	1	2	3	4	5	6	7	8	9	10	11	12	13	14	15	16	17	18	19	20	21	22
1/15	23	24	25	26	27	28	29	30	31	32	33	34	35	36	37	38	39	40	41	42	43	44	45
	46	47	48	49	50	51	52	53	54	55	56	57	58	59	60	61	62	63	64	65	66	67	68
	69	70	71	72	73	74	75	76	77	78	79	80	81	82	83	84	85	86	87	88	89	90	91
	92	93	94	95	96	97	98	99	100	101	102	103	104	105	106	107	108	109	110	111	112	113	114
	115	116	117	118	119	120	121	122	123	124	125	126	127	128	129	130	131	132	133	134	135	136	137
	138	139	140	141	142	143	144	145	146	147	148	149	150	151	152	153	154	155	156	157	158	159	160
	161	162	163	164	165	166	167	168	169	170	171	172	173	174	175	176	177	178	179				
2/15	5	58	29	154	125	34	0	169	80	59	13	42	77	167	32	87	24	92	124	143	114	120	166
	138	64	136	149	57	18	101	119	35	33	113	75	108	104	3	27	39	172	159	129	62	146	142
	19	147	111	70	74	79	10	132	1	161	155	90	15	133	47	112	84	28	160	117	150	49	7
	81	44	63	118	4	158	148	82	69	36	162	86	71	22	26	61	40	126	170	177	23	91	68
	56	110	21	93	107	85	20	128	109	66	83	12	179	141	97	78	157	72	130	99	165	45	11
	152	168	14	16	2	137	140	121	173	50	55	94	144	73	51	98	174	178	17	100	9	122	54
	38	156	131	127	164	102	116	176	30	37	139	95	43	135	53	89	106	171	76	175	153	96	151
115	52	6	123	134	31	103	163	65	105	48	25	8	60	67	88	46	41	145					
3/15	52	92	175	26	45	81	117	74	119	147	120	135	144	87	3	51	20	170	143	125	15	39	5
	174	79	16	176	44	19	69	11	111	121	37	160	88	50	76	129	138	157	86	113	164	142	98
	9	93	166	78	73	167	168	40	131	27	89	156	177	171	116	152	0	127	36	8	153	59	75
	13	105	55	122	132	172	2	58	126	162	30	77	158	17	96	100	42	63	134	154	6	90	128
	83	60	146	124	178	99	123	108	133	159	151	145	61	53	68	31	41	94	35	21	49	82	80
	4	155	7	57	95	62	56	65	140	163	148	23	161	169	47	67	139	72	43	110	46	150	109
	115	32	14	179	85	165	112	25	64	173	10	102	114	71	66	84	24	141	29	104	107	54	12
91	1	118	136	18	101	149	130	103	106	38	70	48	28	137	97	34	22	33					
4/15	165	8	136	2	58	30	127	64	38	164	123	45	78	17	47	105	159	134	124	147	148	109	67
	98	157	57	156	170	46	12	172	29	9	3	144	97	83	151	26	52	10	39	50	104	92	163
	72	125	36	14	55	48	1	149	33	110	6	130	140	89	77	22	171	139	112	113	152	16	7
	85	11	28	153	73	62	44	135	116	4	61	117	53	111	178	94	81	68	114	173	75	101	88
	65	99	126	141	43	15	18	90	35	24	142	25	120	19	154	0	174	93	167	150	107	86	129
	175	87	21	66	106	82	179	118	41	95	145	37	23	168	166	49	103	108	56	91	69	128	121
	96	133	100	161	143	119	102	59	20	40	70	79	80	51	13	177	131	132	176	155	31	63	5
162	76	42	160	115	71	158	54	137	146	32	169	122	138	84	74	60	34	27					
5/15	129	65	160	140	32	50	162	86	177	57	157	9	134	104	24	7	122	46	17	77	31	92	163
	148	133	99	18	0	167	101	110	135	124	71	107	5	123	69	108	141	179	96	113	83	176	52
	117	81	125	59	15	137	170	63	112	88	34	61	106	3	42	100	152	87	171	72	161	4	178
	64	150	10	128	49	26	75	41	102	28	2	168	93	156	12	38	45	151	142	44	66	25	139
	173	51	29	147	175	90	164	80	131	58	114	145	121	70	115	146	120	55	158	8	39	97	159
	138	33	47	116	79	174	74	21	6	130	54	109	76	35	98	155	144	36	94	23	78	165	56
	154	89	132	67	119	143	40	53	20	136	172	91	27	13	127	73	105	85	30	103	19	84	37
48	153	11	166	60	111	14	169	95	118	1	126	68	22	149	43	62	16	82					
6/15	55	146	83	52	62	176	160	68	53	56	81	97	79	113	163	61	58	69	133	108	66	71	86
	144	57	67	116	59	70	156	172	65	149	155	82	138	136	141	111	96	170	90	140	64	159	15
	14	37	54	44	63	43	18	47	7	25	34	29	30	26	39	16	41	45	36	0	23	32	28
	27	38	48	33	22	49	51	60	46	21	4	3	20	13	50	35	24	40	17	42	6	112	93
	127	101	94	115	105	31	19	177	74	10	145	162	102	120	126	95	73	152	129	174	125	72	128
	78	171	8	142	178	154	85	107	75	12	9	151	77	117	109	80	106	134	98	1	122	173	161
	150	110	175	166	131	119	103	139	148	157	114	147	87	158	121	164	104	89	179	123	118	99	88
11	92	165	84	168	124	169	2	130	167	153	137	143	91	100	5	76	132	135					
7/15	174	148	56	168	38	7	110	9	42	153	160	15	46	21	121	88	114	85	13	83	74	81	70
	27	119	118	144	31	80	109	73	141	93	45	16	77	108	57	36	78	124	79	169	143	6	58
	75	67	5	104	125	140	172	8	39	17	29	159	86	87	41	99	89	47	128	43	161	154	101
	163	116	94	120	71	158	145	37	112	68	95	1	113	64	72	90	92	35	167	44	149	66	28

	82	178	176	152	23	115	130	98	123	102	24	129	150	34	136	171	54	107	2	3	60	69	10
	117	91	157	33	105	155	62	162	40	127	14	165	26	52	19	48	137	4	22	122	173	18	11
	111	106	76	53	61	147	97	175	32	59	166	179	135	177	103	100	139	50	146	134	133	96	49
	126	151	84	156	30	138	164	132	12	0	20	63	170	142	65	55	25	51	131				
8/15	71	81	170	101	143	77	128	112	155	41	40	54	57	28	179	114	97	13	18	151	91	88	79
	92	137	27	122	107	135	82	125	103	74	36	9	93	0	86	63	158	148	25	167	116	70	43
	102	106	149	24	169	113	127	34	165	100	136	75	134	156	96	84	178	150	140	20	126	73	68
	130	121	48	53	22	129	99	11	33	124	157	161	29	123	160	55	26	168	98	67	15	7	94
	144	1	61	65	146	42	172	115	59	76	4	162	39	85	12	72	58	44	132	47	141	35	176
	104	139	80	6	95	87	90	173	163	69	32	8	154	145	23	177	111	60	38	171	62	46	21
	5	153	49	78	2	109	147	89	166	152	138	31	14	131	50	37	16	117	66	19	10	159	142
	105	3	164	51	83	174	108	52	17	64	119	45	133	175	110	56	30	120	118				
9/15	23	89	10	142	19	41	1	146	68	87	9	51	114	92	121	69	107	97	166	162	55	174	126
	149	110	128	172	28	111	78	82	120	71	52	5	141	29	30	132	148	72	85	17	160	156	154
	131	164	65	76	125	50	16	130	129	143	133	98	0	42	63	83	173	49	74	43	8	147	61
	36	167	119	27	86	102	48	115	99	38	163	73	101	4	153	118	90	124	151	66	93	123	157
	24	44	168	80	15	39	178	45	21	37	11	136	113	77	122	158	64	81	6	60	54	35	13
	57	171	100	117	46	62	33	175	137	59	103	127	70	108	88	179	40	112	104	170	140	67	32
	105	159	26	96	169	135	109	47	177	56	116	79	106	150	25	94	134	152	22	84	176	139	20
34	165	138	7	91	12	145	58	95	2	144	53	75	14	155	18	31	3	161					
10/15	68	71	54	19	25	21	102	32	105	29	16	79	53	82	107	91	67	94	85	48	83	58	42
	57	28	76	31	26	96	65	119	114	109	9	125	81	43	103	93	70	46	89	112	61	45	66
	38	77	115	56	87	113	100	75	72	60	47	92	36	98	4	59	6	44	20	86	3	73	95
	104	8	34	0	84	111	35	30	64	55	80	40	97	101	2	69	63	74	62	118	110	159	18
	50	33	7	175	51	131	106	134	88	140	117	132	147	153	116	161	10	39	126	136	90	37	174
	41	158	5	120	12	52	99	146	144	78	155	128	165	141	179	150	157	171	143	108	170	22	49
	11	27	160	178	133	142	121	168	173	123	13	15	154	127	139	151	163	172	138	176	145	129	162
	152	177	137	149	167	1	14	169	124	148	164	130	17	156	122	23	166	135	24				
11/15	21	11	12	9	0	6	24	25	85	103	118	122	71	101	41	93	55	73	100	40	106	119	45
	80	128	68	129	61	124	36	126	117	114	132	136	140	144	148	152	156	160	164	168	172	176	20
	18	10	13	16	8	26	27	54	111	52	44	87	113	115	58	116	49	77	95	86	30	78	81
	56	125	53	89	94	50	123	65	83	133	137	141	145	149	153	157	161	165	169	173	177	2	17
	1	4	7	15	29	82	32	102	76	121	92	130	127	62	107	38	46	43	110	75	104	70	91
	69	96	120	42	34	79	35	105	134	138	142	146	150	154	158	162	166	170	174	178	19	5	3
	14	22	28	23	109	51	108	131	33	84	88	64	63	59	57	97	98	48	31	99	37	72	39
	74	66	60	67	47	112	90	135	139	143	147	151	155	159	163	167	171	175	179				
12/15	120	32	38	113	71	31	65	109	36	106	134	66	29	86	136	108	83	70	79	81	105	48	30
	125	107	44	99	75	64	78	51	95	88	49	60	54	122	140	137	89	74	129	82	164	59	3
	67	92	98	42	77	28	121	87	18	21	93	72	2	142	112	9	50	8	90	139	14	97	63
	85	104	124	52	20	118	34	5	94	41	68	80	110	12	133	131	53	116	123	96	61	111	33
	173	165	175	166	169	174	159	148	158	155	145	178	126	100	154	156	179	157	46	149	171	37	153
	163	152	146	177	103	160	147	76	172	144	150	132	176	168	167	162	170	138	151	161	40	26	130
	119	114	117	115	84	57	62	13	47	24	0	7	10	69	19	127	17	16	27	91	4	73	35
102	15	55	23	25	11	56	45	58	128	43	135	1	143	141	6	22	101	39					
13/15	0	4	8	12	16	20	24	28	32	36	40	44	48	52	56	60	64	68	72	76	80	84	88
	92	96	100	104	108	112	116	120	124	128	132	136	140	144	148	152	156	160	164	168	172	176	1
	5	9	13	17	21	25	29	33	37	41	45	49	53	57	61	65	69	73	77	81	85	89	93
	97	101	105	109	113	117	121	125	129	133	137	141	145	149	153	157	161	165	169	173	177	2	6
	10	14	18	22	26	30	34	38	42	46	50	54	58	62	66	70	74	78	82	86	90	94	98
	102	106	110	114	118	122	126	130	134	138	142	146	150	154	158	162	166	170	174	178	3	7	11
	15	19	23	27	31	35	39	43	47	51	55	59	63	67	71	75	79	83	87	91	95	99	103
107	111	115	119	123	127	131	135	139	143	147	151	155	159	163	167	171	175	179					

Table B.1.3 64QAM ($N_{inner} = 64800$ bits)

Code Rate	Order of Group-Wise Interleaving $\pi(j)$ ($0 \leq j < 180$)																						
	0	1	2	3	4	5	6	7	8	9	10	11	12	13	14	15	16	17	18	19	20	21	22
Code Rate	23	24	25	26	27	28	29	30	31	32	33	34	35	36	37	38	39	40	41	42	43	44	45
	46	47	48	49	50	51	52	53	54	55	56	57	58	59	60	61	62	63	64	65	66	67	68
	69	70	71	72	73	74	75	76	77	78	79	80	81	82	83	84	85	86	87	88	89	90	91
	92	93	94	95	96	97	98	99	100	101	102	103	104	105	106	107	108	109	110	111	112	113	114
	115	116	117	118	119	120	121	122	123	124	125	126	127	128	129	130	131	132	133	134	135	136	137
	138	139	140	141	142	143	144	145	146	147	148	149	150	151	152	153	154	155	156	157	158	159	160
	161	162	163	164	165	166	167	168	169	170	171	172	173	174	175	176	177	178	179				
2/15	57	149	83	142	29	20	30	52	5	100	156	22	130	167	121	126	137	158	132	82	138	128	89
	88	162	32	107	3	97	166	125	129	1	6	68	148	40	87	0	80	49	24	78	101	43	112
	75	172	23	154	12	146	19	135	48	170	123	147	95	91	13	35	127	61	60	139	44	59	55
	109	157	177	153	165	66	152	77	98	131	11	81	62	175	141	171	51	155	76	150	174	58	143
	37	63	31	41	140	118	94	27	10	70	56	93	176	124	151	106	46	163	179	4	18	144	178
	161	145	71	114	7	105	133	84	86	17	21	28	54	74	65	110	122	169	64	111	119	42	85
	73	8	116	79	120	69	53	115	67	104	16	173	92	15	159	134	99	96	117	38	9	26	164
47	103	113	136	168	102	14	45	72	25	50	34	36	90	160	2	33	39	108					
3/15	74	72	104	62	122	35	130	0	95	150	139	151	133	109	31	59	18	148	9	105	57	132	102
	100	115	101	7	21	141	30	8	1	93	92	163	108	52	159	24	89	117	88	178	113	98	179
	144	156	54	164	12	63	39	22	25	137	13	41	44	80	87	111	145	23	85	166	83	55	154
	20	84	58	26	126	170	103	11	33	172	155	116	169	142	70	161	47	3	162	77	19	28	97
	124	6	168	107	60	76	143	121	42	157	65	43	173	56	171	90	131	119	94	5	68	138	149
	73	67	53	61	4	86	99	75	36	15	48	177	167	174	51	176	81	120	158	123	34	49	128
	10	134	147	96	160	50	146	16	38	78	91	152	46	127	27	175	135	79	125	82	2	129	153
14	40	32	114	106	17	110	140	71	136	112	45	64	29	69	118	66	37	165					
4/15	141	80	47	89	44	7	46	11	175	173	99	2	155	52	86	128	174	33	170	31	35	162	64
	95	92	4	16	49	137	104	29	9	60	167	50	23	43	176	121	71	132	103	144	39	12	90
	114	131	106	76	118	66	24	58	122	150	57	149	93	53	14	73	165	82	126	97	59	133	154
	153	72	36	5	96	120	134	101	61	115	0	28	42	18	145	156	85	146	6	161	10	22	138
	127	151	87	54	20	139	140	152	13	91	111	25	123	77	78	69	3	177	41	81	19	107	45
	148	70	160	51	21	116	48	157	17	125	142	83	110	37	98	179	129	168	172	1	40	166	159
	147	56	100	63	26	169	135	15	75	84	163	79	143	113	94	74	102	30	38	178	68	108	136
105	158	117	34	109	67	62	32	119	124	171	8	55	65	130	88	112	27	164					
5/15	166	54	6	27	141	134	58	46	55	91	56	100	172	80	18	152	12	108	170	29	144	147	106
	165	17	127	57	88	35	72	5	63	118	1	85	77	61	62	84	159	92	102	98	177	132	139
	59	149	11	8	154	129	33	15	143	4	95	101	53	42	40	9	111	130	123	82	81	114	119
	175	157	41	38	128	161	52	142	7	26	145	2	68	28	126	121	70	16	65	83	125	50	79
	37	74	164	168	160	122	60	32	24	138	75	69	0	36	97	117	14	109	173	120	112	87	176
	124	151	67	13	94	105	133	64	76	153	31	136	140	150	39	96	66	3	115	20	99	171	49
	25	45	22	30	156	158	163	135	21	146	90	169	78	93	178	116	19	155	110	73	104	167	44
113	162	89	47	43	86	48	107	71	137	51	174	103	131	179	148	10	23	34					
6/15	29	17	38	37	27	43	31	35	16	46	44	9	23	1	34	45	14	18	156	19	22	40	50
	24	56	49	26	42	69	47	59	61	66	52	64	65	67	54	170	68	132	51	70	41	21	5
	160	7	13	55	62	53	63	58	3	167	71	57	151	60	36	25	74	39	32	72	85	86	107
	113	48	88	2	129	137	20	73	166	75	77	142	174	15	149	28	145	92	169	30	133	163	119
	82	176	152	134	139	148	164	99	173	104	83	106	112	135	153	0	128	144	98	171	94	97	143
	110	118	127	84	79	108	126	131	93	111	91	4	125	162	157	158	109	140	123	154	150	80	11
	12	146	96	81	165	8	89	138	105	141	103	6	100	161	172	78	101	115	179	147	116	136	122
87	33	130	124	175	120	90	102	10	114	159	76	177	178	121	168	95	117	155					
7/15	103	36	155	175	52	130	16	178	141	86	49	129	73	84	142	177	110	8	96	77	139	167	109
	2	17	37	146	169	54	134	101	78	135	70	153	6	29	41	143	63	47	124	90	31	152	98
	59	133	15	79	164	67	50	128	23	34	154	69	45	9	27	35	156	170	113	127	102	82	149
	176	46	13	22	30	163	60	114	11	92	44	157	74	48	132	24	87	140	66	118	123	104	89

	136	64	107	14	99	43	115	71	117	12	26	38	147	62	57	131	94	33	151	172	116	10	25
	75	144	179	51	120	20	80	160	174	106	1	21	88	137	61	105	5	18	32	158	72	56	125
	28	42	161	168	53	7	100	40	145	171	55	3	95	83	162	173	119	126	91	39	150	165	112
	122	93	76	138	166	108	121	97	81	148	65	111	4	19	85	159	68	58	0				
8/15	86	71	51	48	89	94	46	81	67	49	80	37	55	61	36	57	52	92	60	82	76	72	44
	42	91	62	50	90	40	78	53	58	47	85	70	4	69	43	54	84	93	38	8	64	6	18
	77	95	66	59	83	73	17	87	3	75	65	88	79	14	151	117	32	22	123	30	33	162	144
	9	121	108	139	142	24	34	20	157	159	138	143	29	140	163	150	175	114	31	12	35	145	28
	27	26	16	98	102	103	133	161	21	25	107	153	45	156	23	125	141	56	166	5	1	170	119
	68	134	41	74	179	2	129	169	101	99	109	127	168	176	11	0	122	110	113	146	132	165	19
	13	39	7	164	106	172	154	149	10	173	131	167	63	147	155	100	171	158	160	15	178	148	152
	104	124	177	97	130	118	137	111	126	120	105	115	136	112	96	135	116	174	128				
9/15	175	60	133	11	5	4	70	97	131	80	42	136	50	104	32	75	176	87	109	61	39	107	0
	172	23	90	54	160	48	173	27	100	129	14	7	142	20	103	38	126	157	144	21	64	44	79
	105	146	49	93	1	84	81	145	18	15	106	91	12	169	63	71	125	37	120	138	17	113	31
	130	140	8	25	74	134	115	9	171	46	68	33	116	2	179	52	92	36	78	164	177	24	72
	122	118	162	121	16	73	45	53	77	110	30	66	29	76	158	148	111	94	43	83	139	10	56
	98	114	117	152	174	47	62	128	85	155	178	26	96	41	82	150	143	58	69	127	86	13	141
	35	101	149	108	3	154	51	95	132	135	163	137	28	102	123	112	151	167	59	19	156	119	153
	168	55	65	34	6	159	170	57	67	40	89	147	165	22	99	124	88	161	166				
10/15	16	163	92	56	111	141	65	118	78	55	5	148	19	153	75	128	32	178	22	156	99	124	4
	168	20	115	87	122	9	166	27	155	94	134	38	137	67	161	90	127	43	171	64	162	98	133
	34	138	73	154	100	58	103	169	23	117	88	50	13	175	68	39	102	54	37	149	29	150	104
	59	3	139	69	110	77	131	42	142	25	158	80	47	35	143	72	151	84	57	8	176	61	46
	41	51	10	173	63	107	125	48	11	177	24	30	91	76	109	140	74	114	82	120	1	79	66
	119	93	159	36	174	26	112	101	123	44	145	60	157	97	45	33	167	70	152	85	126	40	135
	62	108	95	49	31	147	71	113	89	132	6	144	18	105	83	130	2	172	17	164	81	52	7
	179	28	160	136	121	14	146	15	106	86	129	12	170	21	116	96	53	0	165				
11/15	12	15	2	16	27	50	35	74	38	70	108	32	112	54	30	122	72	116	36	90	49	85	132
	138	144	150	156	162	168	174	0	14	9	5	23	66	68	52	96	117	84	128	100	63	60	127
	81	99	53	55	103	95	133	139	145	151	157	163	169	175	10	22	13	11	28	104	37	57	115
	46	65	129	107	75	119	110	31	43	97	78	125	58	134	140	146	152	158	164	170	176	4	19
	6	8	24	44	101	94	118	130	69	71	83	34	86	124	48	106	89	40	102	91	135	141	147
	153	159	165	171	177	3	20	7	17	25	87	41	120	47	80	59	62	88	45	56	131	61	126
	113	92	51	98	136	142	148	154	160	166	172	178	21	18	1	26	29	39	73	121	105	77	42
	114	93	82	111	109	67	79	123	64	76	33	137	143	149	155	161	167	173	179				
12/15	83	93	94	47	55	40	38	77	110	124	87	61	102	76	33	35	92	59	74	11	138	72	67
	37	10	95	139	131	44	57	97	53	142	0	136	9	143	86	100	21	15	75	62	19	65	129
	101	79	22	68	73	23	18	81	98	112	8	128	103	25	43	126	54	90	28	109	46	91	41
	82	113	134	52	105	78	27	135	96	56	140	64	66	89	34	120	108	63	45	69	121	88	39
	29	133	106	117	127	32	42	58	71	118	51	84	85	80	104	132	111	30	26	48	50	31	141
	116	123	114	70	107	178	145	173	36	144	130	176	171	175	125	99	162	159	20	164	115	169	172
	165	161	151	119	122	152	157	4	137	148	153	170	154	166	13	150	16	167	174	163	49	6	168
	147	146	1	149	158	179	12	5	160	177	60	24	156	7	155	17	3	2	14				
13/15	146	91	63	144	46	12	58	137	25	79	70	33	134	148	66	38	163	118	139	130	72	92	160
	23	133	153	128	86	152	106	53	93	61	5	158	172	121	135	44	149	168	0	124	143	27	30
	151	114	113	43	138	89	159	17	120	136	102	81	170	176	142	104	21	78	155	8	52	95	62
	40	174	6	131	48	18	1	179	34	123	77	26	84	157	85	56	147	67	76	162	10	51	103
	140	87	175	115	4	101	69	80	169	75	49	97	154	83	14	2	132	96	16	37	166	109	54
	42	28	32	171	119	55	94	65	20	165	3	47	90	117	88	177	11	59	68	73	41	150	111
	127	100	110	31	167	13	122	145	71	22	173	116	126	141	29	39	178	57	125	36	19	7	156
	107	9	98	74	45	161	112	50	99	24	35	164	64	129	15	60	82	108	105				

Table B.1.4 256QAM ($N_{inner} = 64800$)

Code Rate	Order of Group-Wise Interleaving $\pi(j)$ ($0 \leq j < 180$)																						
	0	1	2	3	4	5	6	7	8	9	10	11	12	13	14	15	16	17	18	19	20	21	22
Code Rate	23	24	25	26	27	28	29	30	31	32	33	34	35	36	37	38	39	40	41	42	43	44	45
	46	47	48	49	50	51	52	53	54	55	56	57	58	59	60	61	62	63	64	65	66	67	68
	69	70	71	72	73	74	75	76	77	78	79	80	81	82	83	84	85	86	87	88	89	90	91
	92	93	94	95	96	97	98	99	100	101	102	103	104	105	106	107	108	109	110	111	112	113	114
	115	116	117	118	119	120	121	122	123	124	125	126	127	128	129	130	131	132	133	134	135	136	137
	138	139	140	141	142	143	144	145	146	147	148	149	150	151	152	153	154	155	156	157	158	159	160
	161	162	163	164	165	166	167	168	169	170	171	172	173	174	175	176	177	178	179				
2/15	112	78	104	6	59	80	49	120	114	27	113	3	109	44	69	164	91	137	39	31	21	127	151
	8	47	176	117	68	122	148	79	73	7	166	51	50	116	66	152	61	29	107	22	154	118	94
	24	35	55	38	88	54	2	15	19	67	101	74	169	138	41	162	175	136	62	161	121	163	115
	135	123	25	140	156	58	33	119	111	146	129	150	147	97	18	60	4	81	168	43	105	36	65
	13	5	108	145	23	70	20	173	159	100	128	172	170	1	37	83	102	103	157	139	179	32	144
	92	131	75	155	14	9	149	63	11	134	53	99	17	57	90	30	98	64	40	87	158	77	93
	124	46	171	141	133	85	177	132	26	160	42	34	82	96	48	10	142	125	178	153	72	45	89
52	28	126	143	167	76	86	130	110	174	16	165	56	84	95	0	106	12	71					
3/15	136	28	85	38	40	89	133	117	3	58	154	77	14	179	96	101	26	169	37	83	162	165	24
	66	109	126	10	155	70	157	105	175	67	158	32	42	147	140	30	7	92	59	119	56	0	5
	90	174	13	47	76	88	86	108	27	18	12	8	61	145	75	125	112	69	120	137	116	20	178
	98	176	29	68	168	124	21	35	150	131	159	163	84	23	123	65	103	93	99	102	31	64	74
	46	94	80	129	142	128	148	111	134	173	60	118	2	170	135	1	115	143	95	177	73	43	11
	114	91	78	107	172	25	36	164	149	153	110	44	146	82	127	45	33	50	41	52	156	34	4
	79	141	138	122	53	160	81	16	100	130	71	121	132	9	22	113	6	152	15	171	17	57	49
151	161	63	55	139	166	97	19	51	72	167	106	48	144	87	104	62	54	39					
4/15	13	121	137	29	27	1	70	116	35	132	109	51	55	58	11	67	136	25	145	7	75	107	45
	21	127	52	90	22	100	123	69	112	155	92	151	59	5	179	44	87	56	139	65	170	46	0
	124	78	166	8	61	97	120	103	4	19	64	79	28	134	93	86	60	135	126	53	63	14	122
	17	150	76	42	39	23	153	95	66	50	141	176	34	161	26	106	10	43	85	131	2	147	148
	144	54	115	146	101	172	114	119	3	96	133	99	167	164	9	142	68	149	94	83	16	175	73
	38	143	159	130	84	169	18	138	102	72	47	32	160	82	81	168	30	12	173	156	158	125	98
	62	178	48	163	117	110	91	37	80	105	31	174	111	49	113	108	74	157	128	24	118	40	88
177	154	6	162	129	77	36	165	20	89	140	15	33	104	152	71	171	57	41					
5/15	39	45	128	84	143	148	2	75	43	50	130	87	137	151	7	71	55	51	133	90	140	149	6
	177	37	124	99	83	23	159	0	176	41	121	96	89	30	161	18	172	60	49	134	104	139	166
	14	179	62	48	129	105	146	160	16	174	33	54	132	112	145	150	9	77	34	117	92	82	136
	165	4	67	36	44	101	81	141	156	3	175	58	47	91	102	32	158	13	178	63	118	100	85
	26	167	1	173	38	116	131	107	138	162	8	72	42	115	98	108	24	152	17	171	64	123	94
	110	28	147	19	169	61	46	97	106	144	164	5	70	59	53	127	88	31	153	10	73	66	119
	126	111	29	155	15	170	57	120	125	80	142	168	11	68	56	52	95	103	27	154	21	78	40
122	93	86	25	163	20	79	35	114	135	109	22	157	12	69	65	74	76	113					
6/15	99	100	15	107	54	76	153	174	61	0	36	71	62	137	108	114	65	98	151	19	112	109	152
	117	35	93	43	90	154	73	150	165	23	16	91	5	169	175	120	149	26	59	49	56	156	136
	110	80	58	55	40	103	159	83	127	111	155	167	11	52	116	142	133	1	2	96	77	86	122
	6	131	29	51	21	17	45	126	12	3	168	41	30	37	64	164	78	8	118	113	39	48	140
	14	60	82	134	25	33	50	84	28	105	123	145	7	27	34	92	115	147	74	10	68	102	67
	63	101	18	66	129	24	4	119	87	42	170	143	121	38	57	95	148	89	81	158	171	32	22
	69	53	130	104	161	75	141	9	47	79	162	146	124	157	70	106	31	132	166	128	138	125	44
13	85	88	135	144	173	163	20	46	97	94	139	172	72	160	176	177	178	179					
7/15	24	157	0	43	126	172	135	65	32	18	114	42	162	67	104	61	23	11	4	96	163	75	109
	58	79	154	3	95	168	73	103	60	84	148	113	40	164	173	143	49	29	156	7	89	132	179
	138	53	85	12	117	36	122	66	107	64	28	147	2	90	131	70	144	55	26	15	112	35	128
	176	106	59	80	19	6	92	129	174	99	62	82	13	121	41	127	71	139	63	25	151	9	39

	159	69	142	52	77	21	119	38	167	178	101	56	87	155	5	91	166	169	146	50	81	20	111
	88	165	177	108	47	27	149	115	33	161	72	102	57	86	16	110	97	123	68	100	48	31	14
	8	93	130	170	133	44	78	150	118	94	158	76	134	46	83	152	1	37	160	171	136	54	22
	17	116	34	125	175	105	45	30	153	10	98	124	74	137	51	120	141	140	145				
8/15	85	3	148	161	96	99	154	13	78	160	61	36	21	141	121	115	82	1	59	72	43	135	168
	139	46	10	56	67	108	134	111	105	66	89	137	130	104	143	113	11	84	157	32	73	90	38
	117	146	53	2	60	93	91	71	114	19	47	4	26	75	109	41	50	153	54	163	31	24	106
	42	170	62	80	164	65	128	12	142	167	155	88	8	22	131	158	33	178	145	70	9	51	69
	102	140	173	147	83	165	30	126	100	138	171	103	45	159	27	74	97	122	120	16	52	162	132
	124	94	133	172	149	86	77	25	68	177	64	174	15	0	125	63	35	34	40	179	20	44	7
	55	28	101	150	110	18	119	5	29	76	107	136	112	144	48	81	57	49	92	95	118	17	156
166	23	129	79	37	175	152	87	6	58	127	98	123	39	14	116	169	176	151					
9/15	58	70	23	32	26	63	55	48	35	41	53	20	38	51	61	65	44	29	7	2	113	68	96
	104	106	89	27	0	119	21	4	49	46	100	13	36	57	98	102	9	42	39	33	62	22	95
	101	15	91	25	93	132	69	87	47	59	67	124	17	11	31	43	40	37	85	50	97	140	45
	92	56	30	34	60	107	24	52	94	64	5	71	90	66	103	88	86	84	19	169	159	147	126
	28	130	14	162	144	166	108	153	115	135	120	122	112	139	151	156	16	172	164	123	99	54	136
	81	105	128	116	150	155	76	18	142	170	175	83	146	78	109	73	131	127	82	167	77	110	79
	137	152	3	173	148	72	158	117	1	6	12	8	161	74	143	133	168	171	134	163	138	121	141
160	111	10	149	80	75	165	157	174	129	145	114	125	154	118	176	177	178	179					
10/15	45	31	67	35	159	157	177	2	44	23	73	148	163	118	176	4	14	97	142	37	143	149	179
	3	12	32	140	42	167	166	41	126	13	30	144	57	113	147	173	6	52	24	39	64	80	112
	104	174	11	151	71	109	162	79	171	127	46	92	38	132	81	120	100	1	53	88	76	60	103
	139	99	125	48	93	135	161	77	110	107	121	18	95	69	63	83	111	170	7	16	98	141	61
	86	116	172	130	49	25	40	65	87	108	101	5	21	89	75	43	82	146	105	128	17	29	106
	34	160	155	175	124	15	28	134	62	119	145	72	10	58	91	74	36	68	150	8	9	54	26
	137	56	165	115	114	0	47	27	22	20	168	154	102	123	50	94	66	33	85	59	164	131	51
90	70	138	84	117	178	122	19	96	156	55	78	158	169	129	133	152	136	153					
11/15	27	68	35	117	138	83	127	10	60	73	47	115	155	81	170	9	65	66	52	112	150	77	171
	161	22	20	39	106	147	90	126	165	23	16	45	113	154	86	173	158	24	71	40	107	136	94
	128	163	31	72	33	101	134	80	175	7	61	19	49	111	135	92	130	6	62	74	43	116	133
	89	129	8	28	15	34	105	146	84	174	4	32	75	44	118	132	96	169	159	58	18	42	100
	141	87	131	157	63	11	48	108	151	79	177	168	26	17	36	102	137	95	122	1	25	21	50
	120	153	97	121	0	55	14	46	114	152	91	178	3	30	13	37	103	145	82	125	166	57	76
	51	99	144	85	123	162	56	12	53	119	139	78	179	5	64	70	54	110	148	93	172	164	29
69	38	109	143	88	124	160	59	67	41	104	149	98	176	2	167	156	140	142					
12/15	51	122	91	111	95	100	119	130	78	57	65	26	61	126	105	143	70	132	39	102	115	116	6
	14	3	21	71	134	2	0	140	106	7	118	23	35	20	17	50	48	112	13	66	5	75	42
	129	107	30	45	137	114	37	87	53	85	101	141	120	99	88	117	64	28	135	138	108	113	58
	97	38	124	86	33	74	32	29	128	67	104	80	127	56	34	89	94	49	55	93	136	68	62
	54	40	81	103	121	76	44	84	96	123	154	98	82	142	46	169	131	72	47	69	125	31	83
	36	59	90	79	52	133	60	92	139	110	27	73	43	77	109	63	41	168	147	161	165	175	162
	164	158	157	160	150	171	167	145	151	153	9	155	170	146	166	149	15	159	11	176	152	156	144
148	172	178	24	22	179	4	163	174	173	19	10	177	12	16	1	8	18	25					
13/15	59	85	108	128	49	91	163	3	58	16	106	126	74	141	167	35	57	82	30	123	68	95	160
	42	62	21	102	131	52	142	157	10	55	79	24	130	73	92	179	2	61	11	104	122	45	140
	159	43	148	19	23	111	76	135	169	39	63	77	25	117	75	94	155	5	145	14	26	127	46
	138	158	38	64	86	105	118	50	137	175	7	144	84	22	113	54	98	172	9	146	17	27	114
	51	139	156	37	147	78	103	115	66	97	168	34	60	83	107	121	48	93	174	33	65	87	99
	124	71	136	154	0	150	20	101	112	70	96	170	1	149	80	28	125	53	90	173	6	153	13
	29	116	72	88	165	8	143	12	31	119	47	89	164	40	151	81	109	110	44	134	162	36	152
15	100	129	67	133	166	41	56	18	32	120	69	132	161	4	177	176	178	171					

Table B.1.5 1024QAM ($N_{inner} = 64800$)

Code Rate	Order of Group-Wise Interleaving $\pi(j)$ ($0 \leq j < 180$)																						
	0	1	2	3	4	5	6	7	8	9	10	11	12	13	14	15	16	17	18	19	20	21	22
1/15	23	24	25	26	27	28	29	30	31	32	33	34	35	36	37	38	39	40	41	42	43	44	45
	46	47	48	49	50	51	52	53	54	55	56	57	58	59	60	61	62	63	64	65	66	67	68
	69	70	71	72	73	74	75	76	77	78	79	80	81	82	83	84	85	86	87	88	89	90	91
	92	93	94	95	96	97	98	99	100	101	102	103	104	105	106	107	108	109	110	111	112	113	114
	115	116	117	118	119	120	121	122	123	124	125	126	127	128	129	130	131	132	133	134	135	136	137
	138	139	140	141	142	143	144	145	146	147	148	149	150	151	152	153	154	155	156	157	158	159	160
	161	162	163	164	165	166	167	168	169	170	171	172	173	174	175	176	177	178	179				
2/15	157	25	107	160	37	138	111	35	29	44	15	162	66	20	49	126	89	147	159	174	142	26	146
	10	164	152	57	110	83	167	169	16	6	172	62	173	7	145	4	67	115	50	39	72	79	74
	40	132	42	30	163	161	55	143	63	117	86	121	2	28	69	150	24	177	43	158	27	21	128
	46	118	114	127	135	92	76	19	94	179	3	52	101	137	84	73	108	91	120	47	1	102	58
	68	82	59	119	64	31	61	105	103	151	124	70	8	155	90	166	41	45	178	113	140	75	148
	109	100	125	11	116	34	36	176	170	156	136	171	122	78	87	106	123	149	17	99	175	18	9
	165	153	12	81	77	60	93	104	13	5	88	96	141	133	154	144	48	97	23	14	98	53	134
112	65	0	130	32	168	33	131	22	38	56	80	95	71	85	139	129	51	54					
3/15	113	153	13	8	103	115	137	69	151	111	18	38	42	150	179	130	148	6	4	31	44	68	145
	126	106	24	100	93	21	35	143	57	166	65	53	41	122	7	29	25	136	162	158	26	124	32
	17	168	56	12	39	176	131	132	51	89	101	160	49	87	14	55	127	37	169	110	83	134	107
	46	33	114	108	82	125	109	95	174	62	164	144	16	121	58	80	2	163	159	157	90	104	23
	172	112	19	133	102	75	45	86	63	22	54	105	155	77	178	70	98	40	118	84	78	0	99
	123	5	34	71	96	175	10	30	72	28	74	154	61	91	85	135	152	15	88	165	60	52	149
	147	59	116	120	3	64	140	67	94	27	9	81	43	11	167	139	92	129	20	117	128	50	119
47	1	156	142	170	171	48	177	66	161	79	73	76	173	97	36	141	146	138					
4/15	114	133	4	73	8	139	7	5	177	88	66	11	24	74	49	45	167	81	117	137	46	22	165
	51	68	110	6	1	16	132	130	143	169	2	20	140	94	21	91	126	172	27	162	34	113	142
	166	115	106	160	84	136	175	0	26	151	69	174	59	159	161	170	52	164	80	108	3	23	101
	33	125	111	63	124	98	40	145	9	39	155	149	147	67	76	48	120	119	53	54	138	179	156
	127	13	152	129	123	141	109	89	121	50	10	37	104	144	86	178	96	148	128	56	64	153	95
	12	105	41	154	99	25	171	92	17	134	19	61	32	85	102	14	71	146	163	173	118	57	18
	36	42	78	31	97	55	58	116	90	168	43	72	15	112	93	60	38	103	87	158	35	29	176
150	77	79	122	47	28	135	100	83	65	131	75	157	62	70	44	30	107	82					
5/15	128	4	162	8	77	29	91	44	176	107	149	1	150	9	119	99	71	124	104	41	62	5	118
	50	174	54	111	40	156	92	46	11	17	52	47	97	179	24	153	145	129	2	12	88	101	139
	114	69	96	32	134	55	167	132	123	136	112	102	159	31	87	141	15	61	84	98	37	63	20
	85	53	7	39	117	170	138	116	126	161	120	57	13	76	6	121	155	175	38	158	35	86	78
	10	103	166	95	125	172	67	30	177	73	151	169	163	23	108	43	81	157	58	105	65	26	122
	135	146	72	142	34	133	0	148	89	168	60	109	83	18	27	131	70	56	48	64	93	68	127
	21	75	110	80	14	49	82	143	115	178	154	100	59	74	152	51	137	140	36	42	19	25	94
45	164	16	113	79	22	28	66	106	130	171	147	90	144	165	3	173	160	33					
6/15	66	21	51	55	54	24	33	12	70	63	47	65	145	8	0	57	23	71	59	14	40	42	62
	56	2	43	64	58	67	53	68	61	39	52	69	1	22	31	161	38	30	19	17	18	4	41
	25	44	136	29	36	26	126	177	15	37	148	9	13	45	46	152	50	49	27	77	60	35	48
	178	28	34	106	127	76	131	105	138	75	130	101	167	117	173	113	108	92	135	124	121	97	149
	143	81	32	96	3	78	107	86	98	16	162	150	111	158	172	139	74	142	166	7	5	119	20
	144	151	90	11	156	100	175	83	155	159	128	88	87	93	103	94	140	165	6	137	157	10	85
	141	129	146	122	73	112	132	125	174	169	168	79	84	118	179	147	91	160	163	115	89	80	102
104	134	82	95	133	164	154	120	110	170	114	153	72	109	171	176	99	116	123					
7/15	117	61	46	179	24	161	142	133	11	6	121	44	103	76	22	63	136	151	33	8	123	60	105
	175	18	160	138	147	10	0	125	57	49	75	21	154	140	150	9	169	124	55	48	173	23	157
	97	129	30	7	122	54	99	74	19	153	94	128	15	170	87	59	51	80	111	64	137	146	13
	2	83	62	45	176	108	71	91	131	34	168	82	56	102	72	26	155	92	132	31	166	119	36

	101	178	113	67	98	152	14	5	118	41	104	177	114	70	96	134	32	162	84	40	100	174	110
	158	93	149	27	4	86	38	53	77	115	159	143	130	35	163	89	58	106	73	20	66	90	127
	16	3	85	37	107	172	116	156	95	144	17	165	81	43	50	78	109	68	135	126	29	167	120
	39	47	171	112	69	141	145	28	1	88	42	52	79	25	65	139	148	12	164				
8/15	77	48	82	51	57	69	65	6	71	90	84	81	50	88	61	55	53	73	39	13	79	75	41
	18	38	89	49	93	36	64	47	40	42	76	70	56	3	72	2	54	52	145	19	78	80	63
	87	67	86	10	1	58	17	14	175	91	68	85	94	15	43	74	60	66	37	92	4	9	16
	83	46	44	102	30	112	122	110	29	20	105	138	101	174	33	137	136	131	166	59	34	62	125
	28	26	45	24	23	21	157	98	35	95	22	32	103	27	113	31	119	173	168	118	120	114	149
	159	155	179	160	161	130	123	172	139	124	153	0	109	167	128	107	117	147	177	96	164	152	11
	148	158	129	163	176	151	171	8	106	144	150	169	108	162	143	111	141	133	178	134	146	99	132
	142	104	115	135	121	100	12	170	156	126	5	127	154	97	140	116	165	7	25				
9/15	42	36	135	126	3	17	82	87	172	32	65	70	143	131	10	1	85	147	31	176	66	47	97
	128	8	9	146	73	162	164	57	64	139	91	5	110	150	83	18	27	48	45	133	132	111	124
	89	78	177	19	46	50	102	103	122	4	74	161	175	34	60	58	136	100	115	118	81	75	28
	21	40	61	140	138	113	112	157	151	23	30	69	41	94	96	7	109	152	149	33	179	71	43
	92	105	12	13	154	159	178	24	44	49	107	98	16	2	76	155	35	168	62	56	129	141	116
	123	160	77	25	170	54	39	90	95	121	11	72	153	169	167	51	67	104	134	0	117	79	80
	26	29	37	55	99	142	108	114	86	88	166	163	59	63	101	93	119	15	144	145	165	22	52
53	130	137	125	6	158	84	20	174	38	68	127	106	14	120	148	156	171	173					
10/15	100	22	60	121	40	44	164	170	176	101	88	26	35	4	21	173	140	145	175	174	81	28	72
	112	132	106	42	56	151	147	82	49	91	64	179	89	160	52	139	17	97	63	116	131	154	71
	109	96	135	146	55	38	166	117	65	127	120	129	15	136	74	23	98	43	123	130	69	99	143
	161	46	51	94	61	83	67	156	33	144	148	163	47	92	2	122	24	86	75	108	152	14	77
	7	10	29	19	104	128	142	1	79	107	162	0	118	66	54	153	141	9	85	37	32	114	53
	134	41	158	178	138	76	50	78	84	172	48	133	168	125	13	169	25	16	8	124	159	167	58
	5	11	68	95	27	110	93	62	102	137	126	150	87	105	113	30	119	6	103	57	31	149	80
70	45	165	111	73	36	157	171	3	20	18	90	12	59	39	115	34	177	155					
11/15	33	73	90	107	99	94	53	151	124	8	12	117	21	58	158	77	72	59	123	2	125	157	50
	62	109	75	42	146	118	153	85	10	131	70	32	41	24	143	113	1	93	162	20	35	74	45
	149	161	173	4	28	23	127	148	34	61	96	144	171	140	119	16	126	39	40	57	165	106	172
	139	81	47	164	92	63	105	108	170	3	135	101	121	68	6	111	65	147	150	122	7	84	46
	22	103	86	169	134	44	175	167	89	128	27	31	56	43	102	156	160	141	67	9	110	159	133
	78	154	176	174	5	82	11	25	80	130	163	88	36	166	137	104	48	129	87	95	55	49	145
	178	0	98	64	54	100	37	79	69	38	177	136	114	17	52	19	30	97	51	168	132	138	83
76	13	18	115	71	91	179	112	155	15	14	26	60	29	116	66	120	142	152					
12/15	91	19	11	106	14	40	20	67	32	22	31	23	78	68	79	141	117	95	88	136	52	121	1
	133	4	2	21	122	38	12	69	111	81	82	58	46	112	60	33	73	53	92	75	48	47	110
	80	76	138	87	85	65	130	57	102	83	64	86	100	39	49	125	108	119	6	118	35	61	71
	30	45	94	26	116	98	37	55	44	70	25	7	34	114	135	128	137	84	51	28	97	27	89
	29	62	50	139	56	109	77	59	127	142	96	105	99	90	13	124	120	115	126	143	149	74	41
	178	129	18	131	42	165	101	134	36	140	132	103	72	164	93	54	166	43	123	113	0	154	10
	63	107	162	157	66	104	17	147	167	174	179	3	173	160	155	161	152	156	177	24	170	9	159
16	15	148	5	146	163	172	175	151	169	176	150	153	171	158	168	144	8	145					
13/15	49	2	57	47	31	35	24	39	59	0	45	41	55	53	51	37	33	43	56	38	48	32	50
	23	34	54	1	36	44	52	40	58	122	46	42	30	3	75	73	65	145	71	79	67	69	83
	85	147	63	81	77	61	5	26	62	64	74	70	82	149	76	4	78	84	80	86	66	68	72
	6	60	154	103	95	101	143	9	89	141	128	97	137	133	7	13	99	91	93	87	11	136	90
	88	94	10	8	14	96	104	92	132	142	100	98	12	102	152	139	150	106	146	130	27	108	153
	112	114	29	110	134	116	15	127	125	123	120	148	151	113	126	124	135	129	109	25	28	158	117
	105	115	111	131	107	121	18	170	164	20	140	160	166	162	119	155	168	178	22	174	172	176	16
157	159	171	161	118	17	163	21	165	19	179	177	167	138	173	156	144	169	175					

Table B.1.6 4096QAM ($N_{inner} = 64800$)

Code Rate	Order of Group-Wise Interleaving $\pi(j)$ ($0 \leq j < 180$)																						
	0	1	2	3	4	5	6	7	8	9	10	11	12	13	14	15	16	17	18	19	20	21	22
2/15	23	24	25	26	27	28	29	30	31	32	33	34	35	36	37	38	39	40	41	42	43	44	45
	46	47	48	49	50	51	52	53	54	55	56	57	58	59	60	61	62	63	64	65	66	67	68
	69	70	71	72	73	74	75	76	77	78	79	80	81	82	83	84	85	86	87	88	89	90	91
	92	93	94	95	96	97	98	99	100	101	102	103	104	105	106	107	108	109	110	111	112	113	114
	115	116	117	118	119	120	121	122	123	124	125	126	127	128	129	130	131	132	133	134	135	136	137
	138	139	140	141	142	143	144	145	146	147	148	149	150	151	152	153	154	155	156	157	158	159	160
	161	162	163	164	165	166	167	168	169	170	171	172	173	174	175	176	177	178	179				
3/15	14	129	71	96	171	36	144	64	162	4	86	128	113	7	105	131	2	133	106	79	11	152	26
	118	158	126	17	55	45	111	138	84	6	52	167	38	20	101	31	120	5	112	74	69	121	9
	154	15	146	116	63	1	114	83	124	109	39	75	123	57	49	30	21	40	43	77	157	44	13
	99	34	147	166	56	155	176	95	102	119	161	37	159	97	68	122	163	89	61	107	22	10	127
	87	103	179	172	66	59	8	145	88	132	110	54	47	153	25	32	73	42	148	150	28	91	18
	24	19	53	136	48	76	35	151	173	149	142	160	94	117	169	165	141	80	67	170	164	82	65
	60	135	168	23	100	134	90	98	125	85	137	81	41	156	50	3	29	16	72	177	0	78	62
139	93	46	12	175	130	51	178	92	115	174	27	70	58	33	104	140	108	143					
4/15	136	20	44	36	17	120	89	142	66	35	42	116	14	119	117	29	47	125	11	158	74	25	37
	175	41	145	100	131	173	179	16	77	112	40	58	23	82	168	106	83	34	49	122	2	157	107
	79	137	53	96	33	70	19	38	121	90	118	126	165	109	154	140	10	178	143	92	63	176	146
	134	177	139	3	113	172	9	50	138	61	93	94	88	132	105	151	170	86	12	1	7	56	59
	101	155	95	54	85	13	39	15	76	130	97	110	174	72	150	55	73	99	111	162	26	21	156
	28	160	149	133	104	81	69	84	4	6	147	48	115	169	127	161	71	68	80	91	98	8	57
	171	135	52	5	141	65	75	163	43	144	167	159	129	46	31	30	166	0	148	128	102	103	60
32	18	51	87	114	64	22	164	24	123	27	62	124	152	78	108	67	153	45					
5/15	91	52	36	30	35	6	121	29	150	47	163	2	89	39	65	157	64	122	101	40	84	69	90
	129	10	9	15	162	21	171	43	44	132	158	104	4	72	169	177	103	76	28	78	53	1	151
	161	88	148	42	160	109	100	126	138	108	38	25	3	112	17	124	155	172	134	86	119	94	145
	178	68	26	130	140	115	152	139	37	22	102	14	118	11	98	154	61	146	164	107	131	159	63
	93	7	79	5	137	165	59	77	55	80	117	13	173	144	85	153	66	106	49	34	48	41	143
	142	27	136	18	111	175	123	147	114	19	125	166	149	113	46	31	141	120	57	74	8	20	96
	170	128	97	16	60	110	156	45	82	105	62	99	23	92	32	50	73	56	167	95	24	168	33
116	75	127	81	67	179	174	70	12	58	87	176	0	51	135	83	133	54	71					
6/15	146	89	57	16	164	138	91	78	90	66	122	12	9	157	14	68	112	128	74	45	28	87	158
	56	61	168	18	161	95	99	139	22	65	130	166	118	150	49	142	44	36	1	121	6	46	29
	88	47	0	58	105	43	80	64	107	21	55	151	8	145	163	7	98	123	17	11	153	136	52
	3	13	34	160	102	125	114	152	84	32	97	33	60	62	79	37	129	38	165	71	75	59	144
	127	132	104	53	162	103	120	54	155	116	48	77	76	73	113	119	179	177	41	19	92	109	31
	143	178	108	39	140	106	40	5	25	81	176	101	124	126	72	111	4	173	156	134	86	174	2
	170	35	175	137	15	24	69	96	30	117	67	171	149	169	63	23	20	167	27	147	51	10	82
131	85	110	94	135	172	148	50	154	42	70	115	26	83	141	100	133	93	159					
7/15	66	21	51	55	117	24	33	12	70	63	47	65	145	8	0	57	23	71	59	14	40	42	15
	56	2	43	64	58	67	53	68	61	39	52	69	1	22	31	161	38	30	19	17	18	4	41
	25	44	136	29	36	26	126	177	62	37	148	9	13	45	46	152	50	49	27	77	60	35	48
	178	28	34	106	127	76	131	105	138	75	130	101	167	54	173	113	108	92	135	124	121	97	149
	143	81	32	96	3	78	107	86	98	16	162	150	111	158	172	139	74	142	166	7	5	119	20
	144	151	90	11	156	100	175	83	155	159	128	88	87	93	103	94	140	165	6	137	157	10	85
	141	129	146	122	73	112	132	125	174	169	168	79	84	118	179	147	91	160	163	115	89	80	102
104	134	82	95	133	164	154	120	110	170	114	153	72	109	171	176	99	116	123					
7/15	59	122	161	93	37	112	111	62	42	102	119	72	60	144	34	120	46	31	129	172	149	94	65
	9	0	76	13	61	3	70	40	78	127	35	145	28	48	162	92	73	6	134	66	160	133	101
	4	5	87	106	79	104	168	163	170	57	83	44	54	110	30	50	82	10	148	98	41	22	96
49	90	100	29	39	175	38	109	91	74	159	139	177	71	47	146	63	86	45	123	33	138	51	

	89	88	167	80	142	108	69	7	103	115	99	135	36	11	166	169	8	165	68	173	140	95	179
	2	125	105	1	116	150	174	15	75	64	176	81	55	130	151	156	53	171	16	113	24	117	154
	157	164	143	12	56	152	20	85	84	77	158	107	32	153	147	132	124	52	121	58	118	137	114
	97	19	155	67	25	17	126	23	43	27	21	136	131	26	14	18	128	141	178				
8/15	77	48	82	51	57	69	65	6	71	90	84	81	50	88	61	55	53	73	39	13	79	75	41
	18	38	89	49	93	36	64	47	40	42	76	70	56	3	72	2	54	52	145	19	78	80	63
	87	67	86	10	1	58	17	14	175	91	68	85	94	15	43	74	60	66	37	92	4	9	16
	83	46	44	102	30	112	122	110	29	20	105	138	101	174	33	137	136	131	166	59	34	62	125
	28	26	45	24	23	21	157	98	35	95	22	32	103	27	113	31	119	173	168	118	120	114	149
	159	155	179	160	161	130	123	172	139	124	153	0	109	167	128	107	117	147	177	96	164	152	11
	148	158	129	163	176	151	171	8	106	144	150	169	108	162	143	111	141	133	178	134	146	99	132
	142	104	115	135	121	100	12	170	156	126	5	127	154	97	140	116	165	7	25				
9/15	67	79	72	175	1	92	63	65	36	73	18	3	43	78	5	40	82	20	15	76	28	84	59
	91	93	54	58	60	2	19	66	44	85	48	0	50	166	89	41	24	83	75	55	64	52	98
	39	141	34	74	33	45	99	46	10	69	94	101	56	9	97	96	37	14	31	70	106	113	80
	62	100	13	32	88	57	127	53	68	146	61	7	107	71	51	161	81	49	86	95	103	30	25
	126	87	22	47	27	171	102	6	132	77	90	38	167	4	35	26	118	140	104	128	179	124	109
	159	42	110	21	105	148	142	134	23	117	122	160	12	154	114	156	151	145	169	11	139	177	129
	155	178	138	176	147	121	136	165	170	133	149	150	174	168	125	116	115	164	29	119	153	157	162
173	112	144	172	123	137	16	120	131	111	135	163	17	130	152	108	8	158	143					
10/15	36	21	117	71	38	108	42	61	13	88	97	68	2	67	50	64	95	63	100	9	82	51	45
	78	31	18	103	39	119	25	40	28	72	11	73	86	131	84	111	24	58	60	81	37	89	1
	93	56	69	96	35	57	116	130	55	74	41	169	54	14	26	65	83	165	107	0	52	144	75
	101	8	115	118	85	48	112	80	90	32	173	76	33	16	77	164	104	46	20	98	109	29	114
	7	110	99	53	133	70	87	106	145	4	113	27	59	34	5	102	148	142	79	19	44	159	174
	155	136	94	43	49	152	161	66	3	121	135	147	17	157	30	153	154	137	168	92	149	171	10
	177	134	143	176	179	105	172	47	146	160	23	175	141	91	140	163	132	6	126	124	12	170	167
	151	125	139	150	15	129	162	120	166	156	62	158	178	128	127	22	122	123	138				
11/15	77	97	3	44	119	72	83	116	40	0	111	8	68	43	24	102	49	92	65	31	93	60	17
	76	89	118	70	87	15	67	22	59	95	46	38	125	48	58	140	104	73	47	14	120	1	50
	80	63	62	45	9	25	114	19	82	54	150	121	130	123	37	55	23	98	81	122	103	85	126
	101	78	5	128	148	57	12	107	36	2	109	52	39	66	115	42	156	90	51	91	29	84	18
	144	10	94	64	100	86	71	27	30	32	110	33	113	131	35	34	112	26	108	16	61	56	75
	41	117	69	172	96	149	127	124	173	13	74	105	53	161	146	174	79	88	28	129	134	139	136
	145	170	135	158	154	162	7	169	99	106	137	165	143	4	175	138	133	171	168	147	167	141	163
	176	179	142	11	177	153	151	159	132	20	164	6	157	178	21	166	155	160	152				
12/15	110	16	64	100	55	70	48	26	60	71	93	1	59	88	97	136	67	94	90	72	49	23	41
	92	9	35	37	113	101	111	8	52	56	19	134	151	84	126	159	63	44	65	139	31	57	103
	22	116	172	38	95	36	46	141	114	4	106	149	85	86	66	51	121	105	109	87	6	135	127
	47	123	39	10	148	43	131	147	45	143	5	108	81	2	140	120	132	76	58	137	18	29	125
	17	30	32	156	133	78	91	161	104	174	53	61	50	74	77	33	171	138	28	69	112	119	12
	102	20	167	99	122	117	24	98	115	124	42	7	79	75	128	82	68	80	3	11	54	96	40
	129	142	107	73	175	14	83	150	165	118	89	130	15	163	34	166	173	146	168	153	154	177	62
145	0	178	155	157	179	144	158	152	13	25	176	162	169	164	27	21	160	170					
13/15	87	50	6	42	82	54	96	0	62	124	109	126	23	64	53	20	41	111	145	135	68	2	122
	128	107	7	28	14	125	136	154	10	92	99	84	86	151	108	24	94	148	29	123	13	88	52
	35	61	102	132	95	70	40	129	101	36	51	150	142	152	121	131	116	97	104	31	59	137	83
	112	113	57	77	32	93	49	58	117	78	1	149	37	11	100	85	79	72	66	130	18	63	55
	91	46	146	21	143	44	110	75	138	16	76	45	114	144	119	38	140	65	30	133	153	33	89
	71	115	105	90	56	25	103	147	73	60	47	118	27	69	9	74	48	19	39	43	34	81	139
	3	164	106	134	5	67	80	141	120	98	155	8	156	162	163	165	26	161	168	176	159	170	4
127	22	173	157	171	178	158	17	174	179	167	12	172	166	160	177	169	175	15					

**B.2 PERMUTATION SEQUENCES OF GROUP-WISE INTERLEAVING FOR $N_{INNER} = 16200$
($N_{GROUP} = 45$)**

Table B.2.1 QPSK ($N_{inner} = 16200$)

Code Rate	Order of Group-Wise Interleaving $\pi(j) (0 \leq j < 45)$																						
	0	1	2	3	4	5	6	7	8	9	10	11	12	13	14	15	16	17	18	19	20	21	22
	23	24	25	26	27	28	29	30	31	32	33	34	35	36	37	38	39	40	41	42	43	44	
2/15	0	2	4	6	8	10	12	14	16	18	20	22	24	26	28	30	32	34	36	38	40	42	1
	3	5	7	9	11	13	15	17	19	21	23	25	27	29	31	33	35	37	39	41	43	44	
3/15	15	22	34	19	7	17	28	43	30	32	14	1	11	0	3	9	10	38	24	4	23	18	27
	39	29	33	8	2	40	21	20	36	44	12	37	13	35	6	31	26	16	25	42	5	41	
4/15	0	2	4	6	8	10	12	14	16	18	20	22	24	26	28	30	32	34	36	38	40	42	1
	3	5	7	9	11	13	15	17	19	21	23	25	27	29	31	33	35	37	39	41	43	44	
5/15	35	7	29	11	14	32	38	28	20	17	25	39	19	4	1	12	10	30	0	44	43	2	21
	5	13	34	37	23	15	36	18	42	16	33	31	27	22	3	6	40	24	41	9	26	8	
6/15	7	4	0	5	27	30	25	13	31	9	34	10	17	11	8	12	15	16	18	19	20	21	22
	23	1	35	24	29	33	6	26	14	32	28	2	3	36	37	38	39	40	41	42	43	44	
7/15	3	7	1	4	18	21	22	6	9	5	17	14	13	15	10	20	8	19	16	12	0	11	2
	23	24	25	26	27	28	29	30	31	32	33	34	35	36	37	38	39	40	41	42	43	44	
8/15	0	2	4	6	8	10	12	14	16	18	20	22	24	26	28	30	32	34	36	38	40	42	1
	3	5	7	9	11	13	15	17	19	21	23	25	27	29	31	33	35	37	39	41	43	44	
9/15	0	1	2	3	4	5	6	7	8	9	10	11	12	13	14	15	16	17	18	19	20	21	22
	23	24	25	26	27	28	29	30	31	32	33	34	35	36	37	38	39	40	41	42	43	44	
10/15	1	4	5	6	24	21	18	7	17	12	8	20	23	29	28	30	32	34	36	38	40	42	0
	2	3	14	22	13	10	25	9	27	19	16	15	26	11	31	33	35	37	39	41	43	44	
11/15	0	2	4	6	8	10	12	14	16	18	20	22	24	26	28	30	32	34	36	38	40	42	1
	3	5	7	9	11	13	15	17	19	21	23	25	27	29	31	33	35	37	39	41	43	44	
12/15	0	2	4	6	8	10	12	14	16	18	20	22	24	26	28	30	32	34	36	38	40	42	1
	3	5	7	9	11	13	15	17	19	21	23	25	27	29	31	33	35	37	39	41	43	44	
13/15	26	10	12	38	28	15	0	44	34	24	14	8	40	30	20	13	42	32	22	11	9	36	25
	7	5	37	27	4	16	43	33	23	2	18	39	29	19	6	41	31	21	3	17	35	1	

Table B.2.2 16QAM (Code length = 16200 bits)

Code Rate	Order of Group-Wise Interleaving $\pi(j)$ ($0 \leq j < 45$)																							
	0	1	2	3	4	5	6	7	8	9	10	11	12	13	14	15	16	17	18	19	20	21	22	
2/15	23	24	25	26	27	28	29	30	31	32	33	34	35	36	37	38	39	40	41	42	43	44		
	5	33	18	8	29	10	21	14	30	26	11	23	27	4	7	6	24	44	38	31	34	43	13	
3/15	0	15	42	17	2	20	12	40	39	35	32	1	3	41	37	9	25	19	22	16	28	36		
	18	16	5	29	26	43	23	6	1	24	7	19	37	2	27	3	10	15	36	39	22	12	35	
4/15	33	4	17	30	31	21	9	11	41	0	32	20	40	25	8	34	38	28	14	44	13	42		
	34	3	19	35	25	2	17	36	26	38	0	40	27	10	7	43	21	28	15	6	1	37	18	
5/15	30	32	33	29	22	12	13	5	23	44	14	4	31	20	39	42	11	9	16	41	8	24		
	3	33	39	2	38	29	0	10	25	17	7	21	44	37	8	34	20	1	4	31	11	42	22	
6/15	13	12	28	26	43	30	14	16	23	24	15	5	18	9	36	6	19	32	40	41	35	27		
	12	13	15	30	27	25	11	34	9	4	31	22	6	32	7	21	17	3	1	26	10	33	19	
7/15	2	18	5	28	35	8	16	29	23	14	0	20	24	36	37	38	39	40	41	42	43	44		
	19	3	32	38	16	17	29	33	14	10	6	2	20	15	40	39	12	22	23	34	31	13	44	
8/15	43	36	24	37	42	0	9	4	21	5	35	26	41	7	28	11	25	8	18	1	30	27		
	36	5	22	26	1	13	3	33	9	6	23	20	35	10	17	41	30	15	21	42	29	11	37	
9/15	4	2	38	44	0	18	19	8	31	28	43	14	34	32	25	40	12	16	24	39	27	7		
	4	6	19	2	5	30	20	11	22	12	15	0	36	37	38	39	26	14	34	35	16	13	18	
10/15	42	7	10	25	43	40	17	41	24	33	31	23	32	21	3	27	28	8	9	29	1	44		
	27	11	20	1	7	5	29	35	9	10	34	18	25	28	6	13	17	0	23	16	41	15	19	
11/15	44	24	37	4	31	8	32	14	42	12	2	40	30	36	39	43	21	3	22	26	33	38		
	2	4	41	8	13	7	0	24	3	22	5	32	10	9	36	37	29	11	25	16	20	21	35	
12/15	34	15	1	6	14	27	30	33	12	17	28	23	40	26	31	38	39	18	19	42	43	44		
	3	6	7	27	2	23	10	30	22	28	24	20	37	21	4	14	11	42	16	9	15	26	33	
13/15	40	5	8	44	34	18	0	32	29	19	41	38	17	25	43	35	36	13	39	12	1	31		
	12	7	20	43	29	13	32	30	25	0	17	18	9	1	41	42	6	33	28	14	16	11	39	
	40	15	4	23	5	2	24	22	38	10	8	19	34	26	36	37	27	21	31	3	35	44		

Table B.2.3 64QAM ($N_{inner} = 16200$)

Code Rate	Order of Group-Wise Interleaving $\pi(j)$ ($0 \leq j < 45$)																							
	0	1	2	3	4	5	6	7	8	9	10	11	12	13	14	15	16	17	18	19	20	21	22	
2/15	23	24	25	26	27	28	29	30	31	32	33	34	35	36	37	38	39	40	41	42	43	44		
	7	11	4	38	19	25	2	43	15	26	18	14	9	29	44	32	0	5	35	10	1	12	6	
3/15	36	21	33	37	34	3	31	20	16	40	23	41	22	30	39	13	24	17	42	28	8	27		
	19	34	22	6	29	25	23	36	7	8	24	16	27	43	11	35	5	28	13	4	3	17	15	
4/15	38	20	0	26	12	1	39	31	41	44	30	9	21	42	18	14	32	10	2	37	33	40		
	41	34	32	37	5	8	13	15	30	31	22	25	42	20	23	17	1	40	44	12	6	43	7	
5/15	29	33	16	11	0	35	4	14	28	21	3	24	19	18	36	10	38	26	2	39	27	9		
	25	44	8	39	37	2	11	7	0	12	4	31	33	38	43	21	26	13	28	29	1	27	18	
6/15	17	34	3	42	10	19	20	32	36	40	9	41	5	35	30	22	15	16	6	24	23	14		
	31	12	39	32	30	24	28	15	38	23	27	41	0	6	17	37	42	20	11	4	40	2	3	
7/15	26	10	7	13	25	1	18	8	5	14	36	35	33	22	9	44	16	34	19	21	29	43		
	2	14	10	0	37	42	38	40	24	29	28	35	18	16	20	27	41	30	15	19	9	43	25	
8/15	3	6	7	31	32	26	36	17	1	13	5	39	33	4	8	23	22	11	34	44	12	21		
	36	6	2	20	43	17	33	22	23	25	13	0	10	7	21	1	19	26	8	14	31	35	16	
9/15	5	29	40	11	9	4	34	15	42	32	28	18	37	30	39	24	41	3	38	27	12	44		
	21	5	43	38	40	1	3	17	11	37	10	41	9	15	25	44	14	27	7	18	20	35	16	
10/15	0	6	19	8	22	29	28	34	31	33	30	32	42	13	4	24	26	36	2	23	12	39		
	14	22	18	11	28	26	2	38	10	0	5	12	24	17	29	16	39	13	23	8	25	43	34	
11/15	33	27	15	7	1	9	35	40	32	30	20	36	31	21	41	44	3	42	6	19	37	4		
	31	20	21	25	4	16	9	3	17	24	5	10	12	28	6	19	8	15	13	11	29	22	27	
12/15	14	23	34	26	18	42	2	37	44	39	33	35	41	0	36	7	40	38	1	30	32	43		
	17	11	14	7	31	10	2	26	0	32	29	22	33	12	20	28	27	39	37	15	4	5	8	
13/15	13	38	18	23	34	24	6	1	9	16	44	21	3	36	30	40	35	43	42	25	19	41		
	9	7	15	10	11	12	13	6	21	17	14	20	26	8	25	32	34	23	2	4	31	18	5	
	27	29	3	38	36	39	43	41	42	40	44	1	28	33	22	16	19	24	0	30	35	37		

Table B.2.4 256QAM ($N_{inner} = 16200$)

Code Rate	Order of Group-Wise Interleaving $\pi(j)$ ($0 \leq j < 45$)																							
	0	1	2	3	4	5	6	7	8	9	10	11	12	13	14	15	16	17	18	19	20	21	22	
2/15	23	24	25	26	27	28	29	30	31	32	33	34	35	36	37	38	39	40	41	42	43	44		
	31	3	38	9	34	6	4	18	15	1	21	19	42	20	12	13	30	26	14	2	10	35	28	
3/15	44	23	11	22	16	29	40	27	37	25	41	5	43	39	36	7	24	32	17	33	8	0		
	5	22	23	26	29	27	16	1	4	25	41	21	12	2	6	8	7	19	44	42	39	40	43	
4/15	35	10	28	13	15	37	32	3	24	36	38	11	18	33	30	14	9	34	20	0	17	31		
	38	20	0	34	33	41	14	30	44	7	37	8	4	9	43	15	19	32	23	5	22	26	10	
5/15	12	3	31	36	21	24	11	16	18	17	29	35	42	13	40	1	28	2	25	6	39	27		
	4	23	3	6	18	5	0	2	7	26	21	27	39	42	38	31	1	34	20	37	40	24	43	
6/15	25	33	9	22	36	30	35	11	10	17	32	13	12	41	15	14	19	16	8	44	29	28		
	17	13	25	24	14	21	1	37	2	3	11	22	18	5	10	23	12	4	26	16	38	36	33	
7/15	39	0	6	7	31	32	34	27	35	15	9	30	28	19	8	20	29	40	41	42	43	44		
	13	16	4	12	44	15	8	14	0	3	30	20	35	21	10	6	19	17	26	39	7	24	9	
8/15	27	5	37	23	32	40	31	38	42	34	25	36	2	22	43	33	28	1	18	11	41	29		
	41	2	12	6	33	1	13	11	26	10	39	43	36	23	42	7	44	20	8	38	18	22	24	
9/15	40	4	28	29	19	14	5	9	0	30	25	35	37	27	32	31	34	21	3	15	17	16		
	5	7	9	22	10	12	3	43	6	4	24	13	14	11	15	18	19	17	16	41	25	26	20	
10/15	23	21	33	31	28	39	36	30	37	27	32	34	35	29	2	42	0	1	8	40	38	44		
	28	20	18	38	39	2	3	30	19	4	14	36	7	0	25	17	10	6	33	15	8	26	42	
11/15	24	11	21	23	5	40	41	29	32	37	44	43	31	35	34	22	1	16	27	9	13	12		
	8	13	0	11	9	4	36	37	16	3	10	14	24	20	33	34	25	2	21	31	12	19	7	
12/15	5	27	23	26	1	18	22	35	6	32	30	28	15	29	17	39	38	40	41	42	43	44		
	28	21	10	15	8	22	26	2	14	1	27	3	39	20	34	25	12	6	7	40	30	29	38	
13/15	16	43	33	4	35	9	32	5	36	0	41	37	18	17	13	24	42	31	23	19	11	44		
	9	13	10	7	11	6	1	14	12	8	21	15	4	36	25	30	24	28	29	20	27	5	18	
	17	22	33	0	16	23	31	42	3	40	39	41	43	37	44	26	2	19	38	32	35	34		

Annex C: Constellation Definitions and Figures

C.1 CONSTELLATION DEFINITIONS

This Annex contains the definitions of the constellations used. Table C.1.1 describes the mapping for QPSK. Table C.1.2 to Table C.1.7 define the position vectors for the NUCs from 16QAM up to 256QAM. Table C.1.8 to Table C.1.11 summarize the position vectors for the NUCs for 1024QAM and 4096QAM.

Table C.1.1 QPSK Definition Table for All Code Rates

Input Data Cell y	Constellation Point z_s
00	$(1 + j1)/\sqrt{2}$
01	$(-1 + j1)/\sqrt{2}$
10	$(+1 - j1)/\sqrt{2}$
11	$(-1 - j1)/\sqrt{2}$

Table C.1.2 16QAM Definition Table for Code Rates 2/15-7/15

w/CR	2/15	3/15	4/15	5/15	6/15	7/15
w0	0.7062+j0.7075	0.3620+j0.5534	0.3412+j0.5241	0.3192+j0.5011	0.5115+j1.2092	0.2592+j0.4888
w1	0.7075+j0.7062	0.5534+j0.3620	0.5241+j0.3412	0.5011+j0.3192	1.2092+j0.5115	0.4888+j0.2592
w2	0.7072+j0.7077	0.5940+j1.1000	0.5797+j1.1282	0.5575+j1.1559	0.2663+j0.4530	0.5072+j1.1980
w3	0.7077+j0.7072	1.1000+j0.5940	1.1282+j0.5797	1.1559+j0.5575	0.4530+j0.2663	1.1980+j0.5072

Table C.1.3 16QAM Definition Table for Code Rates 8/15-13/15

w/CR	8/15	9/15	10/15	11/15	12/15	13/15
w0	0.2535+j0.4923	0.2386+j0.5296	0.4487+j1.1657	0.9342+j0.9847	0.9555+j0.9555	0.9517+j0.9511
w1	0.4923+j0.2535	0.5296+j0.2386	1.2080+j0.5377	0.9866+j0.2903	0.9555+j0.2949	0.9524+j0.3061
w2	0.4927+j1.2044	0.4882+j1.1934	0.2213+j0.4416	0.2716+j0.9325	0.2949+j0.9555	0.3067+j0.9524
w3	1.2044+j0.4927	1.1934+j0.4882	0.6186+j0.2544	0.2901+j0.2695	0.2949+j0.2949	0.3061+j0.3067

Table C.1.4 64QAM Definition Table for Code Rates 2/15-7/15

w/CR	2/15	3/15	4/15	5/15	6/15	7/15
w0	0.6474+j0.9831	0.5472+j1.1591	0.5008+j1.2136	1.4327+j0.3305	1.4521+j0.3005	0.1567+j0.3112
w1	0.6438+j0.9829	0.5473+j1.1573	0.4994+j1.2194	1.0909+j0.2971	1.2657+j0.8178	0.1709+j0.3037
w2	0.6471+j0.9767	0.5467+j1.1599	0.5313+j1.1715	1.2484+j0.7803	1.0666+j0.2744	0.2093+j0.6562
w3	0.6444+j0.9762	0.5479+j1.1585	0.5299+j1.1788	0.9762+j0.5715	0.9500+j0.5641	0.3315+j0.6038
w4	0.9839+j0.6475	1.1578+j0.5478	1.2107+j0.5037	0.3309+j1.4326	0.3011+j1.4529	0.3112+j0.1567
w5	0.9778+j0.6474	1.1576+j0.5475	1.2209+j0.5008	0.2979+j1.0923	0.8202+j1.2651	0.3037+j0.1709
w6	0.9835+j0.6434	1.1591+j0.5475	1.1715+j0.5299	0.7829+j1.2477	0.2750+j1.0676	0.6562+j0.2093
w7	0.9777+j0.6433	1.1591+j0.5475	1.1802+j0.5270	0.5739+j0.9763	0.5656+j0.9499	0.6038+j0.3315
w8	0.4659+j0.6393	0.3163+j0.5072	0.2744+j0.4762	0.3901+j0.2112	0.3553+j0.1948	0.2959+j1.4877
w9	0.4643+j0.6386	0.3163+j0.5072	0.2729+j0.4762	0.5317+j0.2475	0.3569+j0.2094	0.8427+j1.2612
w10	0.4661+j0.6353	0.3163+j0.5072	0.2773+j0.4791	0.3945+j0.2289	0.5596+j0.2431	0.2389+j1.0228
w11	0.4639+j0.6350	0.3163+j0.5072	0.2773+j0.4791	0.5236+j0.2894	0.5410+j0.3002	0.5559+j0.8912
w12	0.6378+j0.4671	0.5087+j0.3163	0.4762+j0.2729	0.2108+j0.3911	0.1946+j0.3566	1.4877+j0.2959
w13	0.6352+j0.4673	0.5087+j0.3163	0.4762+j0.2729	0.2475+j0.5327	0.2094+j0.3579	1.2612+j0.8427
w14	0.6385+j0.4656	0.5087+j0.3163	0.4791+j0.2773	0.2287+j0.3955	0.2430+j0.5607	1.0228+j0.2389
w15	0.6353+j0.4653	0.5087+j0.3163	0.4791+j0.2758	0.2898+j0.5246	0.3004+j0.5417	0.8912+j0.5559

Table C.1.5 64QAM Definition Table for Code Rates 8/15-13/15

w/CR	8/15	9/15	10/15	11/15	12/15	13/15
w0	1.4827+j0.2920	0.1305+j0.3311	0.1177+j0.1729	1.4443+j0.2683	1.4480+j0.2403	1.4319+j0.2300
w1	1.2563+j0.8411	0.1633+j0.3162	0.1601+j0.3212	0.7471+j1.2243	0.6406+j1.1995	1.0762+j0.9250
w2	1.0211+j0.2174	0.1622+j0.7113	0.1352+j0.7279	1.1749+j0.7734	1.0952+j0.9115	0.6290+j1.1820
w3	0.8798+j0.5702	0.3905+j0.6163	0.3246+j0.6148	0.7138+j0.8201	0.6868+j0.8108	0.6851+j0.8072
w4	0.2920+j1.4827	0.3311+j0.1305	0.4192+j0.1179	0.1638+j1.0769	1.0500+j0.1642	1.0443+j0.1688
w5	0.8410+j1.2563	0.3162+j0.1633	0.4033+j0.2421	0.2927+j1.4217	0.7170+j0.1473	1.0635+j0.5305
w6	0.2174+j1.0211	0.7113+j0.1622	0.7524+j0.1581	0.1462+j0.7457	1.0519+j0.5188	0.7220+j0.1540
w7	0.5702+j0.8798	0.6163+j0.3905	0.5996+j0.4330	0.4134+j0.7408	0.7146+j0.4532	0.7151+j0.4711
w8	0.3040+j0.1475	0.2909+j1.4626	0.2902+j1.4611	1.0203+j0.1517	0.1677+j1.0405	0.2099+j1.4205
w9	0.3028+j0.1691	0.8285+j1.2399	0.8180+j1.2291	0.6653+j0.1357	0.2402+j1.4087	0.1190+j0.6677
w10	0.6855+j0.1871	0.2062+j1.0367	0.2036+j1.0575	0.9639+j0.4465	0.1369+j0.7073	0.2031+j1.0551
w11	0.6126+j0.3563	0.5872+j0.8789	0.5641+j0.8965	0.6746+j0.4339	0.4044+j0.7057	0.3722+j0.7548
w12	0.1475+j0.3040	1.4626+j0.2909	1.4453+j0.2907	0.1271+j0.1428	0.1374+j0.1295	0.1438+j0.1287
w13	0.1691+j0.3028	1.2399+j0.8285	1.2157+j0.8186	0.3782+j0.1406	0.4185+j0.1357	0.1432+j0.3903
w14	0.1871+j0.6855	1.0367+j0.2062	1.0447+j0.2242	0.1311+j0.4288	0.1325+j0.3998	0.4298+j0.1384
w15	0.3563+j0.6126	0.8789+j0.5872	0.8497+j0.6176	0.3919+j0.4276	0.4122+j0.4120	0.4215+j0.4279

Table C.1.6 256QAM Definition Table for Code Rates 2/15-7/15

w/Shape	NUC_256_2/15	NUC_256_3/15	NUC_256_4/15	NUC_256_5/15	NUC_256_6/15	NUC_256_7/15
w0	0.5553+j1.1262	0.5229+j1.1810	0.2975+j1.0564	0.1524+j0.3087	0.1430+j0.3078	0.1170+j0.3003
w1	0.5673+j1.1336	0.5384+j1.1625	0.5862+j0.9617	0.1525+j0.3087	0.1430+j0.3077	0.1171+j0.3003
w2	0.5593+j1.1204	0.5148+j1.1943	0.2909+j1.0696	0.1513+j0.3043	0.1413+j0.3003	0.1204+j0.3233
w3	0.5636+j1.1321	0.5288+j1.1751	0.5796+j0.9689	0.1513+j0.3043	0.1414+j0.3002	0.1204+j0.3233
w4	0.5525+j1.1249	0.4985+j1.2202	0.2953+j1.3357	0.1682+j0.3004	0.1637+j0.2973	0.1454+j0.2877
w5	0.5637+j1.1320	0.5111+j1.1973	0.7488+j1.2365	0.1682+j0.3005	0.1636+j0.2973	0.1453+j0.2877
w6	0.5598+j1.1181	0.4889+j1.2357	0.3004+j1.5114	0.1663+j0.2964	0.1604+j0.2905	0.1566+j0.3074
w7	0.5659+j1.1274	0.5045+j1.2113	0.8151+j1.3816	0.1663+j0.2964	0.1603+j0.2905	0.1565+j0.3074
w8	0.5579+j1.1381	0.5222+j1.1817	0.3004+j1.0535	0.1964+j0.6584	0.1768+j0.6686	0.1427+j0.6856
w9	0.5617+j1.1471	0.5370+j1.1640	0.5847+j0.9631	0.1965+j0.6583	0.1793+j0.6679	0.1562+j0.6826
w10	0.5593+j1.1346	0.5133+j1.1950	0.2931+j1.0659	0.1967+j0.6652	0.1769+j0.6707	0.1422+j0.6584
w11	0.5672+j1.1430	0.5303+j1.1751	0.5825+j0.9668	0.1968+j0.6652	0.1793+j0.6700	0.1529+j0.6560
w12	0.5533+j1.1355	0.4971+j1.2216	0.2953+j1.3189	0.3371+j0.5987	0.3506+j0.5961	0.3840+j0.5856
w13	0.5632+j1.1421	0.5126+j1.1995	0.7466+j1.2168	0.3370+j0.5987	0.3484+j0.5974	0.3723+j0.5931
w14	0.5567+j1.1325	0.4882+j1.2371	0.2960+j1.4654	0.3414+j0.6039	0.3523+j0.5975	0.3651+j0.5660
w15	0.5641+j1.1363	0.5045+j1.2128	0.8297+j1.3539	0.3413+j0.6039	0.3501+j0.5987	0.3559+j0.5718
w16	1.1309+j0.5597	1.1795+j0.5251	1.0637+j0.2960	0.3087+j0.1524	0.3078+j0.1430	0.3003+j0.1170
w17	1.1405+j0.5660	1.1625+j0.5384	0.9617+j0.5811	0.3087+j0.1525	0.3077+j0.1430	0.3003+j0.1171
w18	1.1348+j0.5588	1.1914+j0.5133	1.0732+j0.2931	0.3043+j0.1513	0.3003+j0.1413	0.3233+j0.1204
w19	1.1491+j0.5638	1.1744+j0.5296	0.9682+j0.5818	0.3043+j0.1513	0.3002+j0.1414	0.3233+j0.1204
w20	1.1245+j0.5615	1.2209+j0.4993	1.3619+j0.2997	0.3004+j0.1682	0.2973+j0.1637	0.2877+j0.1454
w21	1.1333+j0.5627	1.2002+j0.5148	1.2249+j0.7546	0.3005+j0.1682	0.2973+j0.1636	0.2877+j0.1453
w22	1.1284+j0.5578	1.2342+j0.4882	1.5427+j0.3106	0.2964+j0.1663	0.2905+j0.1604	0.3074+j0.1566
w23	1.1436+j0.5636	1.2142+j0.5052	1.3969+j0.8523	0.2964+j0.1663	0.2905+j0.1603	0.3074+j0.1565
w24	1.1196+j0.5620	1.1803+j0.5229	1.0615+j0.2945	0.6584+j0.1964	0.6686+j0.1768	0.6856+j0.1427
w25	1.1347+j0.5665	1.1640+j0.5399	0.9631+j0.5818	0.6583+j0.1965	0.6679+j0.1793	0.6826+j0.1562
w26	1.1379+j0.5611	1.1921+j0.5133	1.0710+j0.2924	0.6652+j0.1967	0.6707+j0.1769	0.6584+j0.1422
w27	1.1440+j0.5638	1.1758+j0.5303	0.9675+j0.5825	0.6652+j0.1968	0.6700+j0.1793	0.6560+j0.1529
w28	1.1221+j0.5594	1.2209+j0.4971	1.3255+j0.2975	0.5987+j0.3371	0.5961+j0.3506	0.5856+j0.3840
w29	1.1318+j0.5686	1.2024+j0.5148	1.1979+j0.7495	0.5987+j0.3370	0.5974+j0.3484	0.5931+j0.3723
w30	1.1302+j0.5619	1.2349+j0.4889	1.4560+j0.3040	0.6039+j0.3414	0.5975+j0.3523	0.5660+j0.3651
w31	1.1386+j0.5662	1.2150+j0.5045	1.3269+j0.8414	0.6039+j0.3413	0.5987+j0.3501	0.5718+j0.3559
w32	0.3394+j0.5381	0.2740+j0.4771	0.2493+j0.5585	0.3183+j1.5992	0.2071+j1.6690	0.1683+j1.7041
w33	0.3397+j0.5360	0.2762+j0.4801	0.2960+j0.5344	0.3186+j1.5991	0.4482+j1.6210	0.4972+j1.6386
w34	0.3387+j0.5324	0.2733+j0.4757	0.2450+j0.5417	0.2756+j1.3848	0.2080+j1.3641	0.1495+j1.3560
w35	0.3400+j0.5335	0.2748+j0.4779	0.2873+j0.5191	0.2759+j1.3847	0.3307+j1.3397	0.3814+j1.3099
w36	0.3374+j0.5306	0.2703+j0.4742	0.2049+j0.3922	0.9060+j1.3557	1.0341+j1.3264	1.0862+j1.3238
w37	0.3405+j0.5343	0.2725+j0.4764	0.2173+j0.3806	0.9058+j1.3559	0.8297+j1.4630	0.8074+j1.5101
w38	0.3379+j0.5324	0.2696+j0.4727	0.1990+j0.3755	0.7846+j1.1739	0.8178+j1.1114	0.8534+j1.0644
w39	0.3400+j0.5317	0.2718+j0.4749	0.2107+j0.3645	0.7843+j1.1741	0.7138+j1.1809	0.6568+j1.1958
w40	0.3397+j0.5370	0.2740+j0.4779	0.2493+j0.5599	0.2257+j0.9956	0.1957+j0.9674	0.1552+j0.9481
w41	0.3400+j0.5383	0.2755+j0.4793	0.2975+j0.5351	0.2259+j0.9956	0.2170+j0.9629	0.2200+j0.9352
w42	0.3381+j0.5347	0.2725+j0.4757	0.2450+j0.5439	0.2276+j1.0326	0.1977+j1.0341	0.1577+j1.0449
w43	0.3382+j0.5347	0.2748+j0.4779	0.2887+j0.5213	0.2278+j1.0326	0.2288+j1.0277	0.2548+j1.0255
w44	0.3379+j0.5342	0.2711+j0.4734	0.2056+j0.3937	0.5446+j0.8635	0.5458+j0.8224	0.5609+j0.7800

w45	0.3389+j0.5332	0.2725+j0.4764	0.2187+j0.3820	0.5445+j0.8636	0.5276+j0.8342	0.5060+j0.8167
w46	0.3402+j0.5347	0.2696+j0.4720	0.1998+j0.3762	0.5694+j0.8910	0.5916+j0.8709	0.6276+j0.8501
w47	0.3384+j0.5340	0.2711+j0.4742	0.2122+j0.3667	0.5692+j0.8911	0.5651+j0.8883	0.5452+j0.9052
w48	0.5350+j0.3394	0.4771+j0.2740	0.5607+j0.2486	1.5992+j0.3183	1.6690+j0.2071	1.7041+j0.1683
w49	0.5363+j0.3397	0.4786+j0.2762	0.5381+j0.2960	1.5991+j0.3186	1.6210+j0.4482	1.6386+j0.4972
w50	0.5342+j0.3389	0.4764+j0.2725	0.5439+j0.2442	1.3848+j0.2756	1.3641+j0.2080	1.3560+j0.1495
w51	0.5384+j0.3380	0.4771+j0.2748	0.5220+j0.2865	1.3847+j0.2759	1.3397+j0.3307	1.3099+j0.3814
w52	0.5329+j0.3363	0.4734+j0.2703	0.3908+j0.2049	1.3557+j0.9060	1.3264+j1.0341	1.3238+j1.0862
w53	0.5330+j0.3387	0.4757+j0.2725	0.3813+j0.2173	1.3559+j0.9058	1.4630+j0.8297	1.5101+j0.8074
w54	0.5311+j0.3389	0.4734+j0.2696	0.3740+j0.1998	1.1739+j0.7846	1.1114+j0.8178	1.0644+j0.8534
w55	0.5332+j0.3380	0.4742+j0.2711	0.3653+j0.2100	1.1741+j0.7843	1.1809+j0.7138	1.1958+j0.6568
w56	0.5313+j0.3397	0.4771+j0.2740	0.5643+j0.2486	0.9956+j0.2257	0.9674+j0.1957	0.9481+j0.1552
w57	0.5324+j0.3400	0.4779+j0.2762	0.5410+j0.2967	0.9956+j0.2259	0.9629+j0.2170	0.9352+j0.2200
w58	0.5339+j0.3402	0.4764+j0.2725	0.5475+j0.2435	1.0326+j0.2276	1.0341+j0.1977	1.0449+j0.1577
w59	0.5360+j0.3405	0.4771+j0.2748	0.5257+j0.2880	1.0326+j0.2278	1.0277+j0.2288	1.0255+j0.2548
w60	0.5285+j0.3397	0.4742+j0.2703	0.3937+j0.2049	0.8635+j0.5446	0.8224+j0.5458	0.7800+j0.5609
w61	0.5317+j0.3379	0.4749+j0.2725	0.3850+j0.2187	0.8636+j0.5445	0.8342+j0.5276	0.8167+j0.5060
w62	0.5319+j0.3381	0.4734+j0.2696	0.3762+j0.1998	0.8910+j0.5694	0.8709+j0.5916	0.8501+j0.6276
w63	0.5327+j0.3395	0.4749+j0.2711	0.3689+j0.2114	0.8911+j0.5692	0.8883+j0.5651	0.9052+j0.5452

Table C.1.7 256QAM Definition Table for Code Rates 8/15-13/15

w/Shape	NUC_256_8/15	NUC_256_9/15	NUC_256_10/15	NUC_256_11/15	NUC_256_12/15	NUC_256_13/15
w0	0.0995+j0.2435	0.0899+j0.1337	0.0754+j0.2310	0.0593+j0.2193	1.1980+j1.1541	1.2412+j1.0688
w1	0.0996+j0.2434	0.0910+j0.1377	0.0768+j0.2305	0.0690+j0.3047	0.9192+j1.2082	1.2668+j0.8034
w2	0.1169+j0.3886	0.0873+j0.3862	0.0924+j0.4136	0.0663+j0.4879	1.2778+j0.8523	0.9860+j1.1758
w3	0.1179+j0.3883	0.0883+j0.3873	0.1043+j0.4125	0.1151+j0.4474	1.0390+j0.9253	1.0365+j0.9065
w4	0.1192+j0.2345	0.1115+j0.1442	0.0829+j0.1135	0.1689+j0.2163	0.6057+j1.2200	1.2111+j0.5135
w5	0.1192+j0.2345	0.1135+j0.1472	0.0836+j0.1149	0.1971+j0.2525	0.7371+j1.4217	1.4187+j0.6066
w6	0.1953+j0.3558	0.2067+j0.3591	0.2682+j0.3856	0.3096+j0.3796	0.6678+j1.0021	1.0103+j0.4879
w7	0.1944+j0.3563	0.1975+j0.3621	0.2531+j0.3906	0.2489+j0.3933	0.8412+j0.9448	1.0380+j0.6906
w8	0.1293+j0.7217	0.1048+j0.7533	0.0836+j0.7817	0.0790+j0.7970	1.2128+j0.5373	0.6963+j1.3442
w9	0.1616+j0.7151	0.1770+j0.7412	0.2052+j0.7608	0.2340+j0.7710	1.0048+j0.5165	0.7089+j1.1122
w10	0.1287+j0.6355	0.1022+j0.5904	0.0838+j0.6034	0.0723+j0.6395	1.4321+j0.6343	0.1256+j1.4745
w11	0.1456+j0.6318	0.1191+j0.5890	0.1394+j0.5961	0.1896+j0.6163	1.0245+j0.7152	0.8331+j0.9455
w12	0.4191+j0.6016	0.4264+j0.6230	0.4861+j0.6331	0.5090+j0.6272	0.6384+j0.6073	0.6615+j0.6012
w13	0.3916+j0.6198	0.3650+j0.6689	0.3661+j0.7034	0.3787+j0.7126	0.8175+j0.5684	0.6894+j0.7594
w14	0.3585+j0.5403	0.3254+j0.5153	0.3732+j0.5159	0.4079+j0.5049	0.6568+j0.7801	0.8373+j0.5633
w15	0.3439+j0.5497	0.2959+j0.5302	0.3095+j0.5511	0.3088+j0.5677	0.8311+j0.7459	0.8552+j0.7410
w16	0.2435+j0.0995	0.3256+j0.0768	0.3030+j0.0811	0.0675+j0.0626	0.1349+j1.4742	1.2666+j0.1027
w17	0.2434+j0.0996	0.3266+j0.0870	0.3017+j0.0853	0.3475+j0.0595	0.1105+j1.2309	1.4915+j0.1198
w18	0.3886+j0.1169	0.4721+j0.0994	0.4758+j0.0932	0.5482+j0.0626	0.0634+j0.9796	1.0766+j0.0945
w19	0.3883+j0.1179	0.4721+j0.1206	0.4676+j0.1242	0.4784+j0.1124	0.1891+j1.0198	0.9007+j0.0848
w20	0.2345+j0.1192	0.2927+j0.1267	0.2425+j0.1081	0.1674+j0.0751	0.4142+j1.4461	1.2454+j0.3064
w21	0.2345+j0.1192	0.2947+j0.1296	0.2447+j0.1115	0.2856+j0.1132	0.3323+j1.2279	1.4646+j0.3600
w22	0.3558+j0.1953	0.3823+j0.2592	0.3837+j0.2813	0.4134+j0.3028	0.4998+j0.9827	1.0570+j0.2995
w23	0.3563+j0.1944	0.3944+j0.2521	0.3959+j0.2642	0.4235+j0.2289	0.3467+j1.0202	0.9140+j0.2530
w24	0.7217+j0.1293	0.7755+j0.1118	0.7929+j0.0859	0.8258+j0.0840	0.0680+j0.6501	0.5461+j0.0679

w25	0.7151+j0.1616	0.7513+j0.2154	0.7652+j0.2324	0.7936+j0.2483	0.2016+j0.6464	0.5681+j0.1947
w26	0.6355+j0.1287	0.6591+j0.1033	0.6365+j0.0872	0.6788+j0.0783	0.0719+j0.8075	0.6874+j0.0537
w27	0.6318+j0.1456	0.6446+j0.1737	0.6207+j0.1757	0.6501+j0.2025	0.2088+j0.8146	0.7375+j0.1492
w28	0.6016+j0.4191	0.5906+j0.4930	0.6149+j0.5145	0.6246+j0.5211	0.4809+j0.6296	0.6290+j0.4553
w29	0.6198+j0.3916	0.6538+j0.4155	0.6987+j0.3934	0.7241+j0.3961	0.3374+j0.6412	0.6007+j0.3177
w30	0.5403+j0.3585	0.4981+j0.3921	0.5063+j0.4029	0.5144+j0.4089	0.4955+j0.8008	0.7885+j0.4231
w31	0.5497+j0.3439	0.5373+j0.3586	0.5526+j0.3356	0.5918+j0.3146	0.3431+j0.8141	0.7627+j0.2849
w32	0.1665+j1.6859	0.1630+j1.6621	0.1598+j1.6262	0.1631+j1.5801	1.2731+j0.1108	0.0816+j1.1632
w33	0.4919+j1.6211	0.4720+j1.5898	0.4733+j1.5637	0.4806+j1.5133	1.0794+j0.0977	0.0830+j0.9813
w34	0.1360+j1.3498	0.1268+j1.3488	0.1307+j1.3502	0.1260+j1.3365	1.5126+j0.1256	0.2528+j1.2315
w35	0.3914+j1.2989	0.3752+j1.2961	0.3877+j1.2983	0.3750+j1.2897	0.9029+j0.0853	0.2502+j1.0100
w36	1.0746+j1.3096	1.0398+j1.2991	1.0328+j1.2617	1.0324+j1.2029	0.5429+j0.0694	0.0732+j0.6827
w37	0.7987+j1.4940	0.7733+j1.4772	0.7675+j1.4398	0.7737+j1.3837	0.6795+j0.0559	0.0811+j0.8293
w38	0.8585+j1.0504	0.8380+j1.0552	0.8496+j1.0508	0.8350+j1.0529	0.5628+j0.1945	0.2159+j0.6673
w39	0.6419+j1.1951	0.6242+j1.2081	0.6297+j1.1967	0.6147+j1.1949	0.7326+j0.1410	0.2359+j0.8283
w40	0.1334+j0.9483	0.1103+j0.9397	0.0910+j0.9531	0.0929+j0.9596	1.2283+j0.3217	0.4302+j1.4458
w41	0.2402+j0.9271	0.2415+j0.9155	0.2649+j0.9198	0.2768+j0.9260	1.0269+j0.3261	0.5852+j0.9680
w42	0.1323+j1.0786	0.1118+j1.1163	0.1080+j1.1340	0.1095+j1.1349	1.4663+j0.3716	0.4528+j1.2074
w43	0.2910+j1.0470	0.3079+j1.0866	0.3214+j1.0926	0.3250+j1.0941	0.9085+j0.2470	0.4167+j1.0099
w44	0.5764+j0.7648	0.5647+j0.7638	0.5941+j0.7527	0.6086+j0.7556	0.6160+j0.4549	0.5035+j0.6307
w45	0.4860+j0.8252	0.4385+j0.8433	0.4371+j0.8528	0.4514+j0.8566	0.7818+j0.4247	0.5359+j0.7954
w46	0.6693+j0.8561	0.6846+j0.8841	0.7093+j0.8880	0.7161+j0.8933	0.5938+j0.3170	0.3580+j0.6532
w47	0.5348+j0.9459	0.5165+j1.0034	0.5235+j1.0090	0.5294+j1.0121	0.7600+j0.2850	0.3841+j0.8207
w48	1.6859+j0.1665	1.6489+j0.1630	1.6180+j0.1602	1.5809+j0.1471	0.0595+j0.0707	0.0576+j0.0745
w49	1.6211+j0.4919	1.5848+j0.4983	1.5540+j0.4734	1.5253+j0.4385	0.1722+j0.0706	0.0581+j0.2241
w50	1.3498+j0.1360	1.3437+j0.1389	1.3411+j0.1336	1.3380+j0.1363	0.0599+j0.2119	0.1720+j0.0742
w51	1.2989+j0.3914	1.2850+j0.4025	1.2883+j0.3955	1.2837+j0.4026	0.1748+j0.2114	0.1753+j0.2222
w52	1.3096+j1.0746	1.2728+j1.0661	1.2561+j1.0337	1.2476+j0.9785	0.4134+j0.0701	0.0652+j0.5269
w53	1.4940+j0.7987	1.4509+j0.7925	1.4311+j0.7676	1.4137+j0.7196	0.2935+j0.0705	0.0611+j0.3767
w54	1.0504+j0.8585	1.0249+j0.8794	1.0362+j0.8626	1.0246+j0.8681	0.4231+j0.2066	0.1972+j0.5178
w55	1.1951+j0.6419	1.1758+j0.6545	1.1845+j0.6419	1.1771+j0.6494	0.2979+j0.2100	0.1836+j0.3695
w56	0.9483+j0.1334	0.9629+j0.1113	0.9546+j0.0957	0.9782+j0.0985	0.0638+j0.5002	0.4145+j0.0709
w57	0.9271+j0.2402	0.9226+j0.2849	0.9163+j0.2834	0.9383+j0.2922	0.1905+j0.4966	0.4266+j0.2100
w58	1.0786+j0.1323	1.1062+j0.1118	1.1282+j0.1128	1.1455+j0.1158	0.0612+j0.3552	0.2912+j0.0730
w59	1.0470+j0.2910	1.0674+j0.3393	1.0838+j0.3340	1.0972+j0.3418	0.1810+j0.3533	0.2982+j0.2177
w60	0.7648+j0.5764	0.7234+j0.6223	0.7329+j0.6204	0.7446+j0.6273	0.4630+j0.4764	0.4766+j0.4821
w61	0.8252+j0.4860	0.8211+j0.4860	0.8428+j0.4615	0.8573+j0.4721	0.3231+j0.4895	0.4497+j0.3448
w62	0.8561+j0.6693	0.8457+j0.7260	0.8680+j0.7295	0.8767+j0.7377	0.4416+j0.3397	0.3334+j0.5025
w63	0.9459+j0.5348	0.9640+j0.5518	0.9959+j0.5426	1.0059+j0.5518	0.3083+j0.3490	0.3125+j0.3601

Table C.1.8 1024QAM Definition Table for Code Rates 2/15-7/15

u/CR	2/15	3/15	4/15	5/15	6/15	7/15
u0	0.3317	0.2382	0.1924	0.1313	0.1275	0.0951
u1	0.3321	0.2556	0.1940	0.1311	0.1276	0.0949
u2	0.3322	0.2749	0.2070	0.1269	0.1294	0.1319
u3	0.3321	0.2558	0.2050	0.1271	0.1295	0.1322
u4	0.3327	0.2748	0.3056	0.3516	0.3424	0.3170
u5	0.3328	0.2949	0.3096	0.3504	0.3431	0.3174
u6	0.3322	0.2749	0.2890	0.3569	0.3675	0.3936
u7	0.3322	0.2558	0.2854	0.3581	0.3666	0.3921
u8	0.9369	0.9486	0.7167	0.6295	0.6097	0.5786
u9	0.9418	0.8348	0.7362	0.6301	0.6072	0.5789
u10	0.9514	0.7810	0.7500	0.6953	0.7113	0.7205
u11	0.9471	0.8348	0.7326	0.6903	0.7196	0.7456
u12	0.9448	0.9463	0.9667	0.9753	0.9418	0.9299
u13	0.9492	0.8336	0.9665	1.0185	1.0048	1.0084
u14	0.9394	0.9459	1.1332	1.2021	1.2286	1.2349
u15	0.9349	1.4299	1.4761	1.4981	1.5031	1.5118

Table C.1.9 1024QAM Definition Table for Code Rates 8/15-13/15

u/CR	8/15	9/15	10/15	11/15	12/15	13/15
u0	0.0773	0.0638	0.0592	0.0502	0.0354	0.0325
u1	0.0773	0.0638	0.0594	0.0637	0.0921	0.0967
u2	0.1614	0.1757	0.1780	0.1615	0.1602	0.1623
u3	0.1614	0.1756	0.1790	0.1842	0.2185	0.2280
u4	0.3086	0.3069	0.2996	0.2760	0.2910	0.2957
u5	0.3085	0.3067	0.3041	0.3178	0.3530	0.3645
u6	0.4159	0.4333	0.4241	0.4040	0.4264	0.4361
u7	0.4163	0.4343	0.4404	0.4686	0.4947	0.5100
u8	0.5810	0.5765	0.5561	0.5535	0.5763	0.5878
u9	0.5872	0.5862	0.6008	0.6362	0.6531	0.6696
u10	0.7213	0.7282	0.7141	0.7293	0.7417	0.7566
u11	0.7604	0.7705	0.8043	0.8302	0.8324	0.8497
u12	0.9212	0.9218	0.9261	0.9432	0.9386	0.9498
u13	1.0349	1.0364	1.0639	1.0704	1.0529	1.0588
u14	1.2281	1.2234	1.2285	1.2158	1.1917	1.1795
u15	1.4800	1.4646	1.4309	1.3884	1.3675	1.3184

Table C.1.10 4096QAM Definition Table for Code Rates 2/15-7/15

u/CR	2/15	3/15	4/15	5/15	6/15	7/15
u0	0.2826	0.2038	0.1508	0.1257	0.1041	0.0810
u1	0.2885	0.2038	0.1468	0.1257	0.1041	0.0808
u2	0.2944	0.2155	0.1456	0.1257	0.1087	0.0807
u3	0.2885	0.2155	0.1479	0.1257	0.1089	0.0810
u4	0.2944	0.2155	0.1491	0.1257	0.1094	0.1456
u5	0.3003	0.2155	0.1444	0.1257	0.1094	0.1457
u6	0.2944	0.2097	0.1491	0.1257	0.1094	0.1456
u7	0.2885	0.2038	0.1508	0.1257	0.1109	0.1456
u8	0.2944	0.2796	0.3368	0.3599	0.3319	0.3059
u9	0.3003	0.2912	0.3368	0.3599	0.3319	0.3060
u10	0.3003	0.3029	0.3334	0.3484	0.3348	0.3056
u11	0.3003	0.2970	0.3363	0.3484	0.3348	0.3056
u12	0.2944	0.2970	0.3386	0.3484	0.3657	0.4043
u13	0.3003	0.3029	0.3357	0.3484	0.3657	0.4042
u14	0.2944	0.2796	0.3340	0.3599	0.3657	0.4036
u15	0.2885	0.2796	0.3374	0.3599	0.3657	0.4036
u16	0.9714	0.7222	0.6448	0.6112	0.5875	0.5684
u17	0.8596	0.7397	0.6569	0.6112	0.5876	0.5682
u18	0.7889	0.7455	0.7101	0.6969	0.5876	0.5700
u19	0.8478	0.7339	0.6979	0.7026	0.5877	0.5704
u20	0.8242	0.7397	0.6974	0.6969	0.6648	0.7155
u21	0.7771	0.7513	0.7124	0.6969	0.6651	0.7186
u22	0.8360	0.7455	0.6575	0.6112	0.6968	0.7425
u23	0.9184	0.7339	0.6465	0.6112	0.7018	0.7385
u24	1.1657	1.3046	1.3549	1.4052	0.9102	0.9163
u25	0.9479	1.0833	1.1931	1.2281	0.9102	0.9089
u26	0.8419	0.9785	1.0117	1.0054	0.9780	0.9771
u27	0.9302	1.0134	0.9857	0.9482	0.9842	1.0012
u28	0.9950	0.9901	0.9689	0.9425	1.1892	1.1766
u29	0.8713	0.9610	0.9967	0.9939	1.2411	1.2355
u30	1.0185	1.0658	1.1683	1.1882	1.4707	1.4381
u31	1.4660	1.6424	1.6391	1.6566	1.7274	1.6851

Table C.1.11 4096QAM Definition Table for Code Rates 8/15-13/15

u/CR	8/15	9/15	10/15	11/15	12/15	13/15
u0	0.0501	0.0415	0.0397	0.0253	0.0262	0.0176
u1	0.0553	0.0478	0.0397	0.0285	0.0262	0.0487
u2	0.0562	0.0592	0.0659	0.0844	0.0828	0.0781
u3	0.0562	0.0592	0.0659	0.0848	0.0842	0.1080
u4	0.1677	0.1656	0.1443	0.1460	0.1337	0.1399
u5	0.1687	0.1663	0.1453	0.1460	0.1389	0.1713
u6	0.1687	0.1663	0.1819	0.2078	0.1887	0.2053
u7	0.1718	0.1663	0.1826	0.2078	0.2018	0.2378
u8	0.2963	0.2861	0.2591	0.2708	0.2466	0.2720
u9	0.2963	0.2863	0.2591	0.2708	0.2675	0.3076
u10	0.2963	0.2877	0.3128	0.3360	0.3096	0.3412
u11	0.2968	0.2877	0.3128	0.3360	0.3393	0.3754
u12	0.4234	0.4144	0.3872	0.4051	0.3796	0.4156
u13	0.4240	0.4178	0.3872	0.4052	0.4118	0.4522
u14	0.4248	0.4204	0.4549	0.4742	0.4506	0.4893
u15	0.4248	0.4204	0.4549	0.4742	0.4897	0.5260
u16	0.5584	0.5352	0.5290	0.5417	0.5296	0.5643
u17	0.5590	0.5370	0.5302	0.5446	0.5712	0.6051
u18	0.5679	0.5673	0.6069	0.6118	0.6136	0.6469
u19	0.5729	0.5683	0.6081	0.6209	0.6586	0.6885
u20	0.7078	0.6848	0.6911	0.6857	0.7060	0.7336
u21	0.7090	0.6848	0.6969	0.7107	0.7544	0.7790
u22	0.7610	0.7694	0.7787	0.7734	0.8043	0.8255
u23	0.7640	0.7838	0.8012	0.8174	0.8624	0.8776
u24	0.8966	0.8808	0.8802	0.8791	0.9152	0.9254
u25	0.8979	0.9039	0.9248	0.9425	0.9718	0.9749
u26	1.0135	1.0050	1.0037	1.0131	1.0325	1.0276
u27	1.0393	1.0619	1.0861	1.0904	1.1017	1.0870
u28	1.1817	1.1797	1.1870	1.1787	1.1756	1.1474
u29	1.2459	1.2898	1.2894	1.2766	1.2541	1.2121
u30	1.4232	1.4381	1.4122	1.3852	1.3405	1.2835
u31	1.6336	1.6223	1.5629	1.5162	1.4431	1.3644

C.2 CONSTELLATION FIGURES

The constellations are shown graphically in Figure C.2.1 for QPSK, Figure C.2.2 for 16QAM, Figure C.2.3 for 64QAM, Figure C.2.4 for 256QAM, Figure C.2.5 for 1024QAM and Figure C.2.6 for 4096QAM.

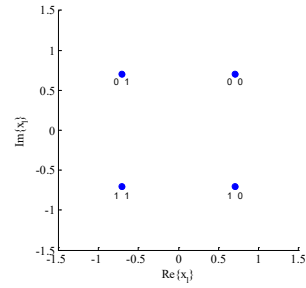

Figure C.2.1 Constellation of QPSK.

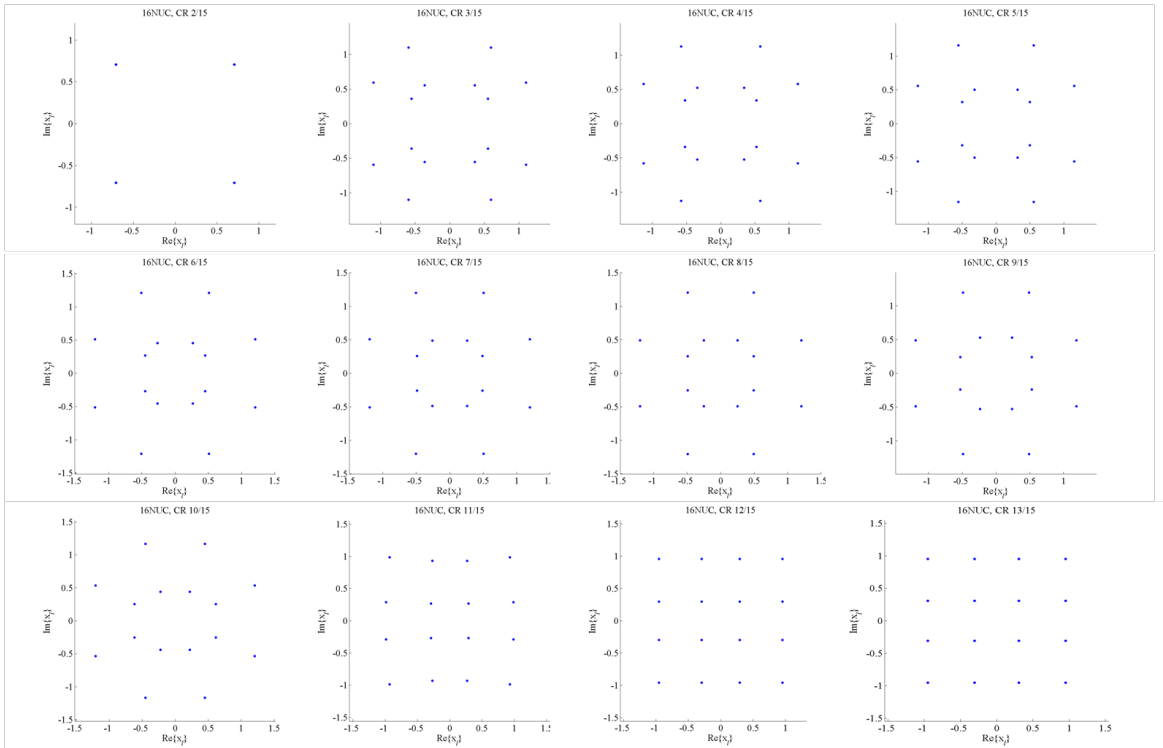

Figure C.2.2 Constellations of 16QAM.

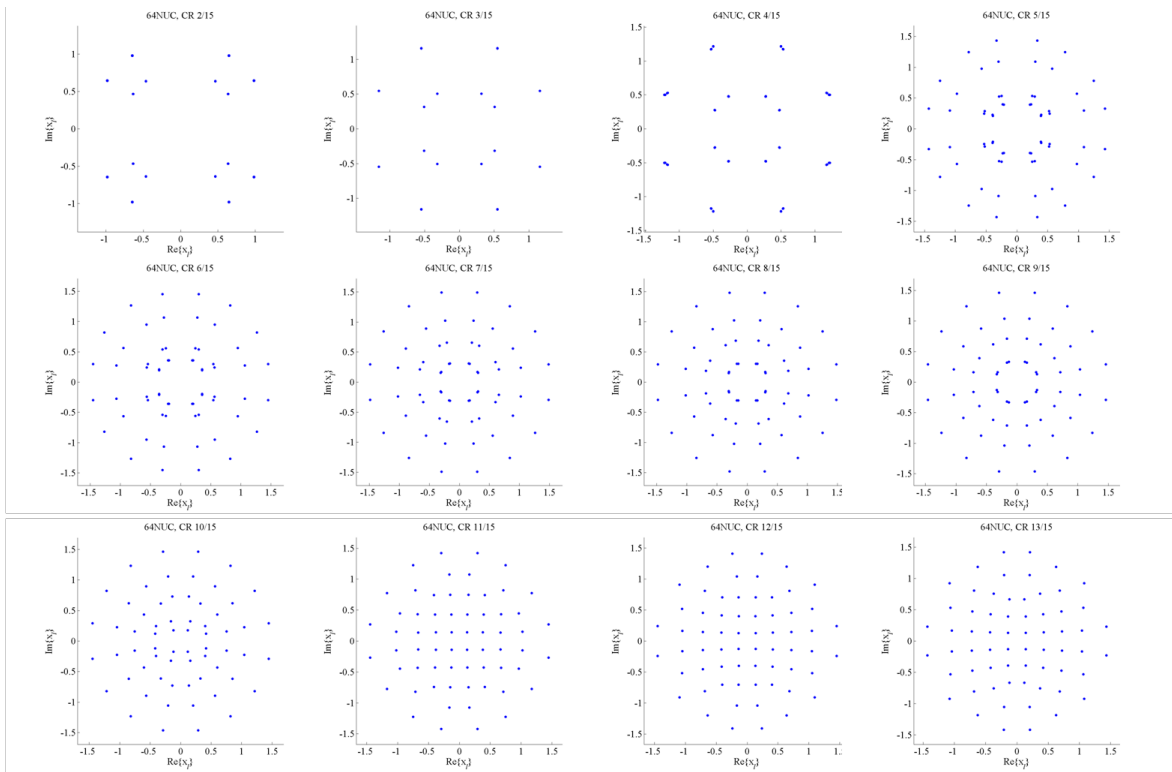

Figure C.2.3 Constellations of 64QAM.

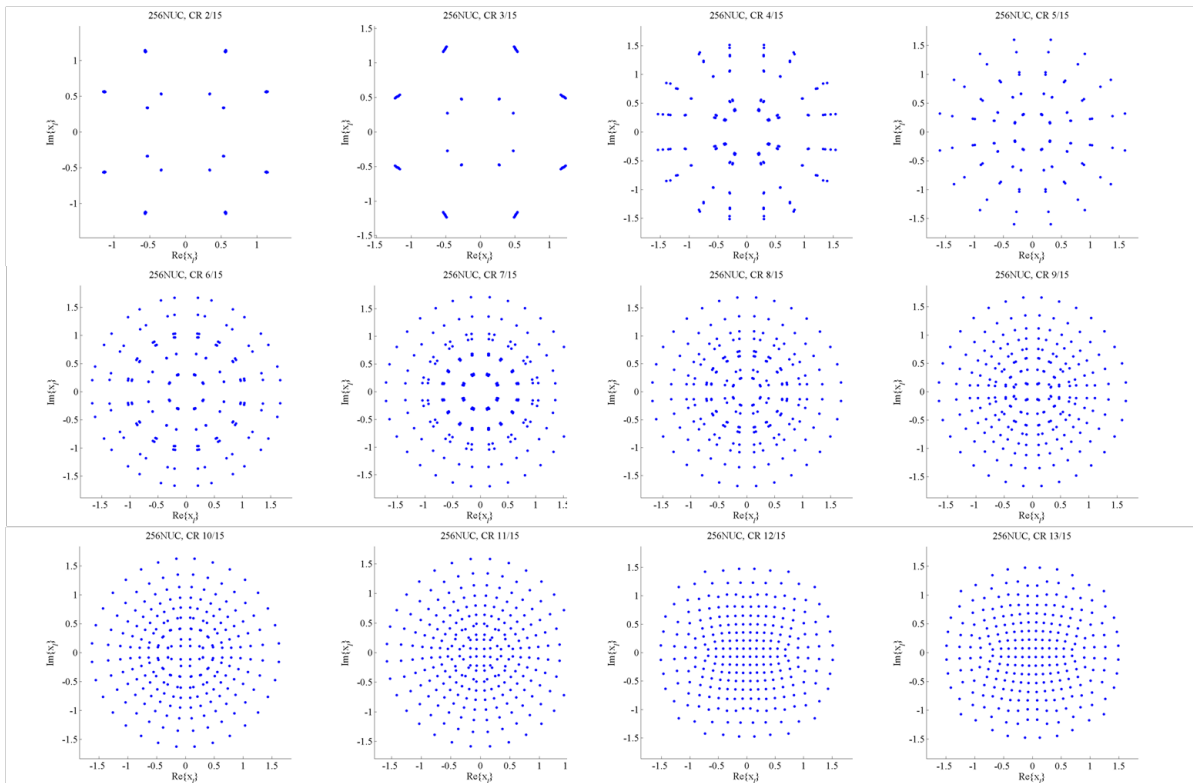

Figure C.2.4 Constellations of 256QAM.

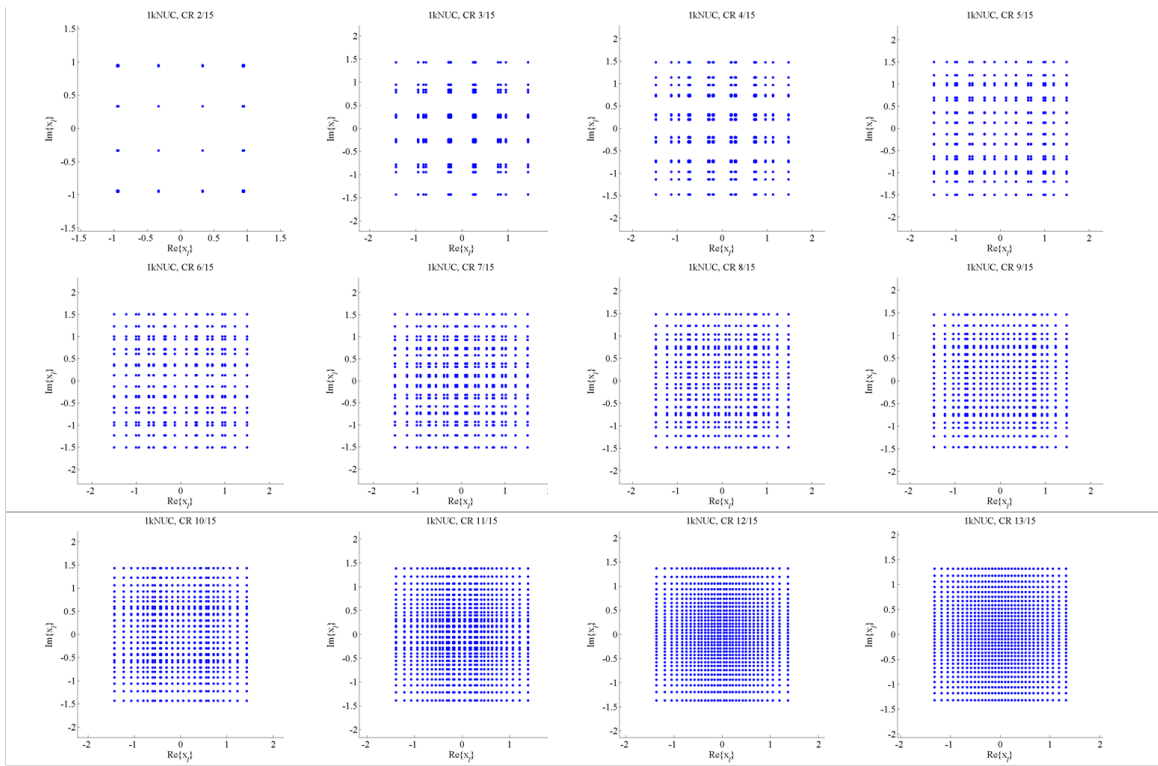

Figure C.2.5 Constellations of 1024QAM.

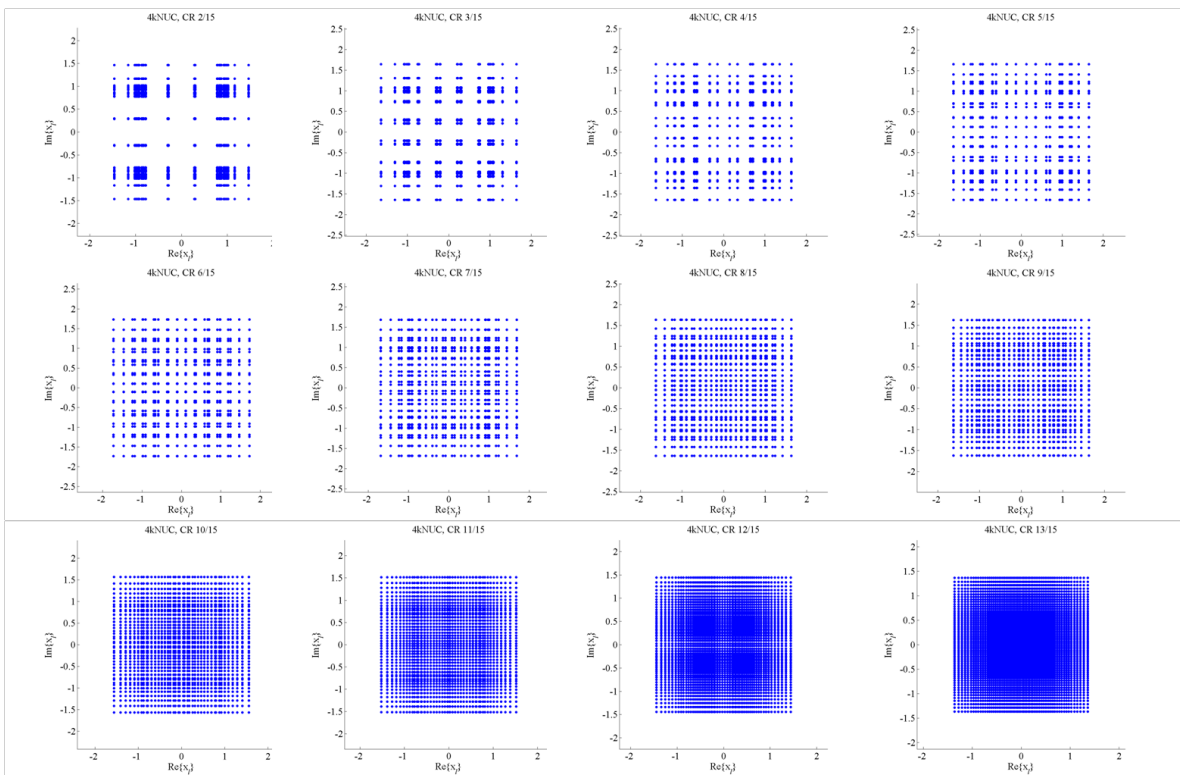

Figure C.2.6 Constellations of 4096QAM.

C.3 CONSTELLATION LABELING

The bit labeling of the non-uniform constellations shall be defined according to the following four tables. The real and imaginary parts shall use the same bit labeling.

Table C.3.1 Constellation Mapping for the Real Part of 1024QAM

$y_{1,s}$	1	1	1	1	1	1	1	1	1	1	1	1	1	1	1	1
$y_{3,s}$	0	0	0	0	0	0	0	0	1	1	1	1	1	1	1	1
$y_{5,s}$	0	0	0	0	1	1	1	1	1	1	1	1	0	0	0	0
$y_{7,s}$	0	0	1	1	1	1	0	0	0	0	1	1	1	1	0	0
$y_{9,s}$	0	1	1	0	0	1	1	0	0	1	1	0	0	1	1	0
$Re(z_s)$	$-u_{15}$	$-u_{14}$	$-u_{13}$	$-u_{12}$	$-u_{11}$	$-u_{10}$	$-u_9$	$-u_8$	$-u_7$	$-u_6$	$-u_5$	$-u_4$	$-u_3$	$-u_2$	$-u_1$	$-u_0$
$y_{1,s}$	0	0	0	0	0	0	0	0	0	0	0	0	0	0	0	0
$y_{3,s}$	1	1	1	1	1	1	1	1	0	0	0	0	0	0	0	0
$y_{5,s}$	0	0	0	0	1	1	1	1	1	1	1	1	0	0	0	0
$y_{7,s}$	0	0	1	1	1	1	0	0	0	0	1	1	1	1	0	0
$y_{9,s}$	0	1	1	0	0	1	1	0	0	1	1	0	0	1	1	0
$Re(z_s)$	u_0	u_1	u_2	u_3	u_4	u_5	u_6	u_7	u_8	u_9	u_{10}	u_{11}	u_{12}	u_{13}	u_{14}	u_{15}

Table C.3.2 Constellation Mapping for the Imaginary Part of 1024QAM

$y_{0,s}$	1	1	1	1	1	1	1	1	1	1	1	1	1	1	1	1
$y_{2,s}$	0	0	0	0	0	0	0	0	1	1	1	1	1	1	1	1
$y_{4,s}$	0	0	0	0	1	1	1	1	1	1	1	1	0	0	0	0
$y_{6,s}$	0	0	1	1	1	1	0	0	0	0	1	1	1	1	0	0
$y_{8,s}$	0	1	1	0	0	1	1	0	0	1	1	0	0	1	1	0
$Im(z_s)$	$-u_{15}$	$-u_{14}$	$-u_{13}$	$-u_{12}$	$-u_{11}$	$-u_{10}$	$-u_9$	$-u_8$	$-u_7$	$-u_6$	$-u_5$	$-u_4$	$-u_3$	$-u_2$	$-u_1$	$-u_0$
$y_{0,s}$	0	0	0	0	0	0	0	0	0	0	0	0	0	0	0	0
$y_{2,s}$	1	1	1	1	1	1	1	1	0	0	0	0	0	0	0	0
$y_{4,s}$	0	0	0	0	1	1	1	1	1	1	1	1	0	0	0	0
$y_{6,s}$	0	0	1	1	1	1	0	0	0	0	1	1	1	1	0	0
$y_{8,s}$	0	1	1	0	0	1	1	0	0	1	1	0	0	1	1	0
$Im(z_s)$	u_0	u_1	u_2	u_3	u_4	u_5	u_6	u_7	u_8	u_9	u_{10}	u_{11}	u_{12}	u_{13}	u_{14}	u_{15}

Table C.3.3 Constellation Mapping for the Real Part of 4096QAM

$y_{1,s}$		1	1	1	1	1	1	1	1	1	1	1	1	1	1	1
$y_{3,s}$	0	0	0	0	0	0	0	0	0	0	0	0	0	0	0	0
$y_{5,s}$	0	0	0	0	0	0	0	0	1	1	1	1	1	1	1	1
$y_{7,s}$	0	0	0	0	1	1	1	1	1	1	1	1	0	0	0	0
$y_{9,s}$	0	0	1	1	1	1	0	0	0	0	1	1	1	1	0	0
$y_{11,s}$	0	1	1	0	0	1	1	0	0	1	1	0	0	1	1	0
$Re(z_s)$	$-U_{31}$	$-U_{30}$	$-U_{29}$	$-U_{28}$	$-U_{27}$	$-U_{26}$	$-U_{25}$	$-U_{24}$	$-U_{23}$	$-U_{22}$	$-U_{21}$	$-U_{20}$	$-U_{19}$	$-U_{18}$	$-U_{17}$	$-U_{16}$
$y_{1,s}$	1	1	1	1	1	1	1	1	1	1	1	1	1	1	1	1
$y_{3,s}$	1	1	1	1	1	1	1	1	1	1	1	1	1	1	1	1
$y_{5,s}$	1	1	1	1	1	1	1	1	0	0	0	0	0	0	0	0
$y_{7,s}$	0	0	0	0	1	1	1	1	1	1	1	1	0	0	0	0
$y_{9,s}$	0	0	1	1	1	1	0	0	0	0	1	1	1	1	0	0
$y_{11,s}$	0	1	1	0	0	1	1	0	0	1	1	0	0	1	1	0
$Re(z_s)$	$-U_{15}$	$-U_{14}$	$-U_{13}$	$-U_{12}$	$-U_{11}$	$-U_{10}$	$-U_9$	$-U_8$	$-U_7$	$-U_6$	$-U_5$	$-U_4$	$-U_3$	$-U_2$	$-U_1$	$-U_0$
$y_{1,s}$	0	0	0	0	0	0	0	0	0	0	0	0	0	0	0	0
$y_{3,s}$	1	1	1	1	1	1	1	1	1	1	1	1	1	1	1	1
$y_{5,s}$	0	0	0	0	0	0	0	0	1	1	1	1	1	1	1	1
$y_{7,s}$	0	0	0	0	1	1	1	1	1	1	1	1	0	0	0	0
$y_{9,s}$	0	0	1	1	1	1	0	0	0	0	1	1	1	1	0	0
$y_{11,s}$	0	1	1	0	0	1	1	0	0	1	1	0	0	1	1	0
$Re(z_s)$	U_0	U_1	U_2	U_3	U_4	U_5	U_6	U_7	U_8	U_9	U_{10}	U_{11}	U_{12}	U_{13}	U_{14}	U_{15}
$y_{1,s}$	0	0	0	0	0	0	0	0	0	0	0	0	0	0	0	0
$y_{3,s}$	0	0	0	0	0	0	0	0	0	0	0	0	0	0	0	0
$y_{5,s}$	1	1	1	1	1	1	1	1	0	0	0	0	0	0	0	0
$y_{7,s}$	0	0	0	0	1	1	1	1	1	1	1	1	0	0	0	0
$y_{9,s}$	0	0	1	1	1	1	0	0	0	0	1	1	1	1	0	0
$y_{11,s}$	0	1	1	0	0	1	1	0	0	1	1	0	0	1	1	0
$Re(z_s)$	U_{16}	U_{17}	U_{18}	U_{19}	U_{20}	U_{21}	U_{22}	U_{23}	U_{24}	U_{25}	U_{26}	U_{27}	U_{28}	U_{29}	U_{30}	U_{31}

Table C.3.4 Constellation Mapping for the Imaginary Part of 4096QAM

$y_{0,s}$	1	1	1	1	1	1	1	1	1	1	1	1	1	1	1	1
$y_{2,s}$	0	0	0	0	0	0	0	0	0	0	0	0	0	0	0	0
$y_{4,s}$	0	0	0	0	0	0	0	0	1	1	1	1	1	1	1	1
$y_{6,s}$	0	0	0	0	1	1	1	1	1	1	1	1	0	0	0	0
$y_{8,s}$	0	0	1	1	1	1	0	0	0	0	1	1	1	1	0	0
$y_{10,s}$	0	1	1	0	0	1	1	0	0	1	1	0	0	1	1	0
$Im(z_s)$	$-U_{31}$	$-U_{30}$	$-U_{29}$	$-U_{28}$	$-U_{27}$	$-U_{26}$	$-U_{25}$	$-U_{24}$	$-U_{23}$	$-U_{22}$	$-U_{21}$	$-U_{20}$	$-U_{19}$	$-U_{18}$	$-U_{17}$	$-U_{16}$
$y_{0,s}$	1	1	1	1	1	1	1	1	1	1	1	1	1	1	1	1
$y_{2,s}$	1	1	1	1	1	1	1	1	1	1	1	1	1	1	1	1
$y_{4,s}$	1	1	1	1	1	1	1	1	0	0	0	0	0	0	0	0
$y_{6,s}$	0	0	0	0	1	1	1	1	1	1	1	1	0	0	0	0
$y_{8,s}$	0	0	1	1	1	1	0	0	0	0	1	1	1	1	0	0
$y_{10,s}$	0	1	1	0	0	1	1	0	0	1	1	0	0	1	1	0
$Im(z_s)$	$-U_{15}$	$-U_{14}$	$-U_{13}$	$-U_{12}$	$-U_{11}$	$-U_{10}$	$-U_9$	$-U_8$	$-U_7$	$-U_6$	$-U_5$	$-U_4$	$-U_3$	$-U_2$	$-U^1$	$-U^0$
$y_{0,s}$	0	0	0	0	0	0	0	0	0	0	0	0	0	0	0	0
$y_{2,s}$	0	1	1	1	1	1	1	1	1	1	1	1	1	1	1	1
$y_{4,s}$	0	0	0	0	0	0	0	0	1	1	1	1	1	1	1	1
$y_{6,s}$	0	0	0	0	1	1	1	1	1	1	1	1	0	0	0	0
$y_{8,s}$	0	0	1	1	1	1	0	0	0	0	1	1	1	1	0	0
$y_{10,s}$	0	1	1	0	0	1	1	0	0	1	1	0	0	1	1	0
$Im(z_s)$	U_0	U_1	U_2	U_3	U_4	U_5	U_6	U_7	U_8	U_9	U_{10}	U_{11}	U_{12}	U_{13}	U_{14}	U_{15}
$y_{0,s}$	0	0	0	0	0	0	0	0	0	0	0	0	0	0	0	0
$y_{2,s}$	0	0	0	0	0	0	0	0	0	0	0	0	0	0	0	0
$y_{4,s}$	1	1	1	1	1	1	1	1	0	0	0	0	0	0	0	0
$y_{6,s}$	0	0	0	0	1	1	1	1	1	1	1	1	0	0	0	0
$y_{8,s}$	0	0	1	1	1	1	0	0	0	0	1	1	1	1	0	0
$y_{10,s}$	0	1	1	0	0	1	1	0	0	1	1	0	0	1	1	0
$Im(z_s)$	U_{16}	U_{17}	U_{18}	U_{19}	U_{20}	U_{21}	U_{22}	U_{23}	U_{24}	U_{25}	U_{26}	U_{27}	U_{28}	U_{29}	U_{30}	U_{31}

Annex D: Continual Pilot (CP) Patterns

D.1 REFERENCE AND ADDITIONAL CP INDICES

Table D.1.1 gives the absolute carrier indices for the common CP set CP_{32} . Table D.1.2 gives the absolute carrier indices for the common CP set CP_{16} . Table D.1.3 gives the absolute carrier indices for the common CP set CP_8 . Table D.1.4 gives the relative carrier indices for the additional scattered pilot bearing continual pilot sets arranged by FFT size and scattered pilot pattern.

Carrier indices specified in this annex represent either absolute carrier indices or relative carrier indices as indicated. Absolute carrier indices are indexed on the maximum possible number of carriers regardless of whether carrier reduction has been configured and hence range from 0 to $NoC_{max} - 1$. Relative carrier indices are indexed on the configured number of carriers (which is a function in part of the configured carrier reduction coefficient) and hence range from 0 to $NoC - 1$. Continual pilots with absolute carrier indices that lie outside the configured range of carriers for transmission shall not be transmitted.

Table D.1.1 Common CP Absolute Carrier Indices CP_{32}

236	316	356	412	668	716	868	1100	1228	1268	1340	1396	1876	1916	2140	2236	2548	2644	2716	2860
3004	3164	3236	3436	3460	3700	3836	4028	4124	4132	4156	4316	4636	5012	5132	5140	5332	5372	5500	
5524	5788	6004	6020	6092	6428	6452	6500	6740	7244	7316	7372	7444	7772	7844	7924	8020	8164	8308	
8332	8348	8788	8804	9116	9140	9292	9412	9436	9604	10076	10204	10340	10348	10420	10660	10684			
10708	11068	11132	11228	11356	11852	11860	11884	12044	12116	12164	12268	12316	12700	12772					
12820	12988	13300	13340	13564	13780	13868	14084	14308	14348	14660	14828	14876	14948	15332					
15380	15484	15532	15604	15764	15788	15796	16292	16420	16516	16580	16940	16964	16988	17228					
17300	17308	17444	17572	18044	18212	18236	18356	18508	18532	18844	18860	19300	19316	19340					
19484	19628	19724	19804	19876	20204	20276	20332	20404	20908	21148	21196	21220	21556	21628					
21644	21860	22124	22148	22276	22316	22508	22516	22636	23012	23332	23492	23516	23524	23620					
23812	23948	24188	24212	24412	24484	24644	24788	24932	25004	25100	25412	25508	25732	25772					
26252	26308	26380	26420	26548	26780	26932	26980	27236	27292	27332	27412								

Note: The common set of absolute carrier indices CP_{32} can also be calculated from only half the number of absolute carriers (e.g. absolute carrier indices 236 to 13780 and here defined as $CP_{32,L}$). The right half of CP_{32} , that is $CP_{32,R}$ can be generated by reversing and shifting $CP_{32,L}$ to give a mirror image of the first half of CP_{32} . This is summarized by the following equations:

$$CP_{32,R}(k) = 27648 - CP_{32,L}(95 - k)$$

$$CP_{32} = [CP_{32,L}, CP_{32,R}]$$

for $k = 0, 1, \dots, 95$ where $[a, b]$ indicates concatenation of a and b .

Table D.1.2 Common CP Absolute Carrier Indices CP_{16}

118	178	334	434	614	670	938	1070	1274	1358	1502	1618	1730	1918	2062	2078	2318	2566	2666	2750
2894	3010	3214	3250	3622	3686	3886	3962	4082	4166	4394	4558	4646	4718	5038	5170	5210	5342	5534	
5614	5926	5942	6058	6134	6350	6410	6650	6782	6934	7154	7330	7438	7666	7742	7802	7894	8146	8258	
8470	8494	8650	8722	9022	9118	9254	9422	9650	9670	9814	9902	10102	10166	10454	10598	10778			
10822	11062	11138	11254	11318	11666	11758	11810	11974	12106	12242	12394	12502	12706	12866					
13126	13190	13274	13466	13618	13666														

The common set of absolute carrier indices CP_{16} can also be calculated as described in Section 8.1.4.1.

Table D.1.3 Common CP Absolute Carrier Indices CP_8

59	167	307	469	637	751	865	1031	1159	1333	1447	1607	1811	1943	2041	2197	2323	2519	2605	2767
2963	3029	3175	3325	3467	3665	3833	3901	4073	4235	4325	4511	4627	4825	4907	5051	5227	5389	5531	
5627	5833	5905	6053	6197	6353	6563	6637	6809											

The common set of absolute carrier indices CP_8 can also be calculated as described in Section 8.1.4.1.

Table D.1.4 Additional Scattered Pilot Bearing Continual Pilot Relative Carrier Indices for Each FFT Size and Scattered Pilot Pattern Combination

Pilot Pattern	FFT Size		
	32K	16K	8K
SP3_2	6939	3471	1731
SP3_4		3471	1731
		5778	2886
		11469	5733
SP4_2		3460	1732
SP4_4		3460	1732
		5768	2888
		11452	5724
SP6_2	6942	3462	1734
SP6_4		3462	1734
		5772	2892
		11466	5730
SP8_2	6920	3464	1736
SP8_4		3464	1736
		5776	2896
		11448	5720
SP12_2	6924	3468	1740
SP12_4		3468	1740
		5784	2904
		11460	5748
SP16_2	6928	3472	1744
SP16_4		3472	1744
		5792	(2912)
		11440	(5744)
SP24_2	6936	3480	
SP24_4		3480	
		5808	
		11496	
SP32_2	6944	3488	(1696)
SP32_4		3488 (5824) (11488)	See Table D.1.5

Relative carrier indices given in parentheses in Table D.1.4 are not used if C_{red_coeff} is an odd number.

For 8K FFT size with SP32_4, additional CP sets for various values of C_{red_coeff} are given in Table D.1.5.

Table D.1.5 Additional Scattered Pilot Bearing Continual Pilot Relative Carrier Indices for SP32_4 in 8K FFT

<i>C_{red_coeff}</i>				
0	1	2	3	4
1696	none	1696	1696	1696
2880			2880	2880
5728				5728

Annex E: Scattered Pilot (SP) Patterns

E.1 SISO SCATTERED PILOT PATTERNS

The scattered pilot patterns are shown in the figures below.

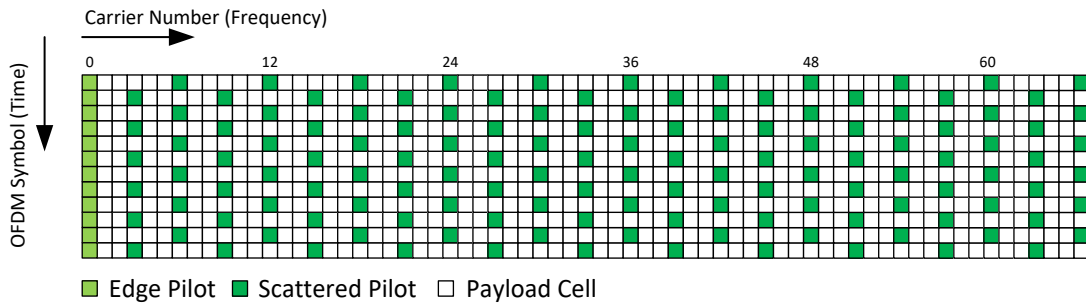

Figure E.1.1 Scattered pilot pattern SP3_2 (SISO, $D_X = 3$, $D_Y = 2$).

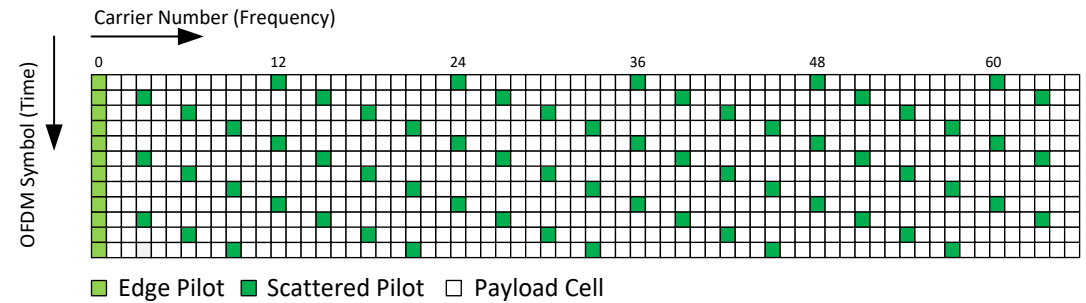

Figure E.1.2 Scattered pilot pattern SP3_4 (SISO, $D_X = 3$, $D_Y = 4$).

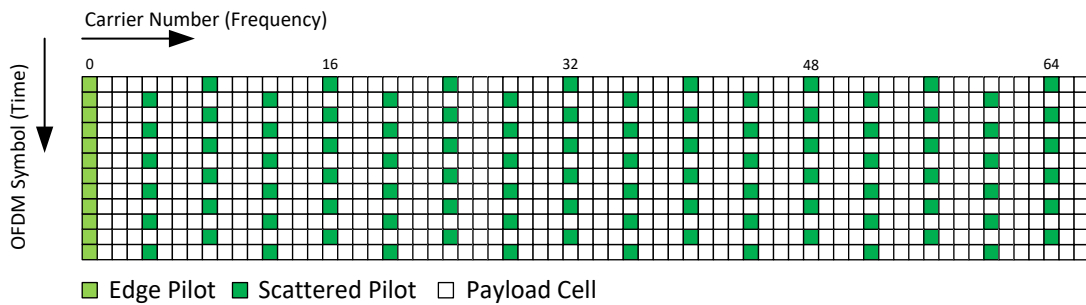

Figure E.1.3 Scattered pilot pattern SP4_2 (SISO, $D_X = 4$, $D_Y = 2$).

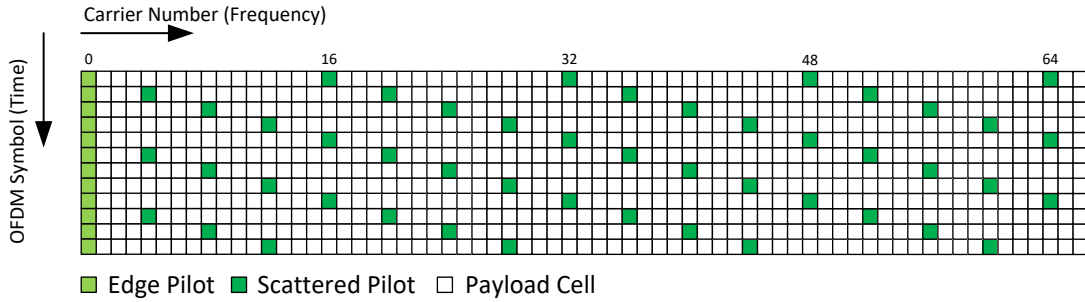

Figure E.1.4 Scattered pilot pattern SP4_4 (SISO, $D_X = 4$, $D_Y = 4$).

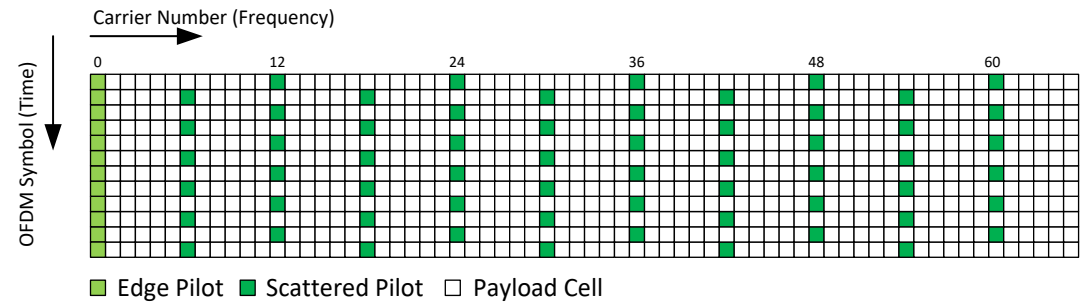

Figure E.1.5 Scattered pilot pattern SP6_2 (SISO, $D_X = 6$, $D_Y = 2$).

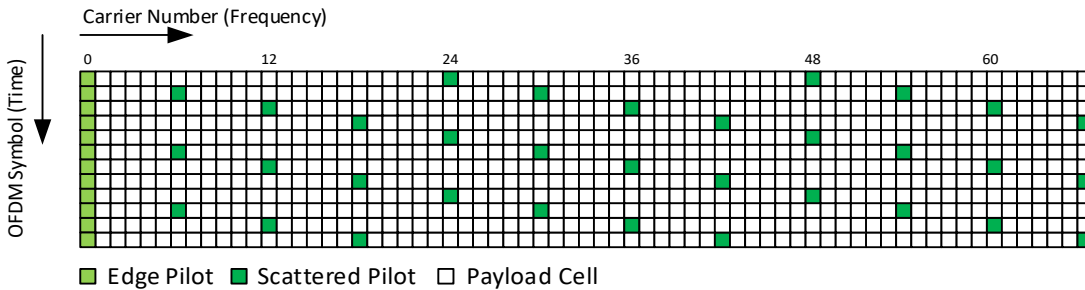

Figure E.1.6 Scattered pilot pattern SP6_4 (SISO, $D_X = 6$, $D_Y = 4$).

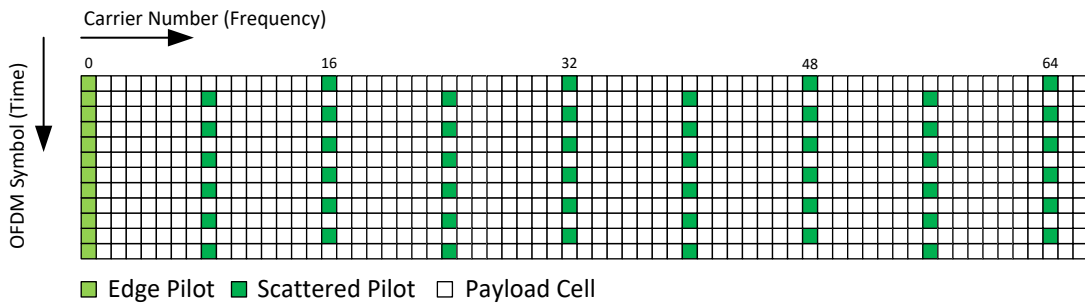

Figure E.1.7 Scattered pilot pattern SP8_2 (SISO, $D_X = 8$, $D_Y = 2$).

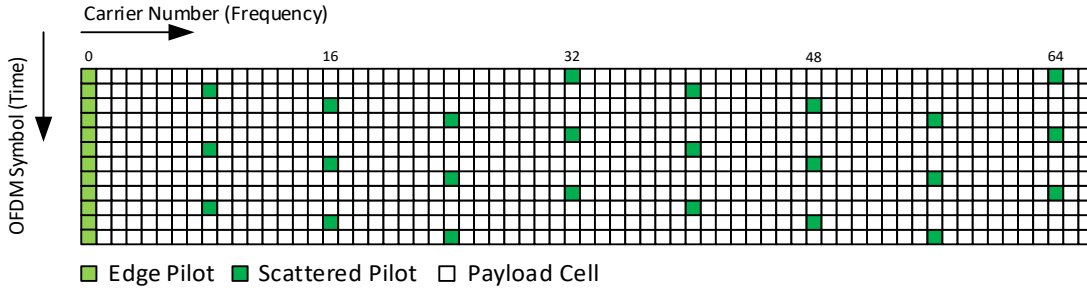

Figure E.1.8 Scattered pilot pattern SP8_4 (SISO, $D_X = 8$, $D_Y = 4$).

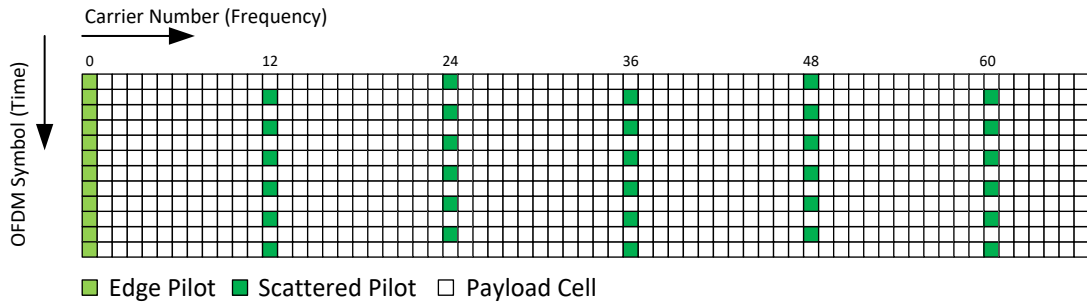

Figure E.1.9 Scattered pilot pattern SP12_2 (SISO, $D_X = 12$, $D_Y = 2$).

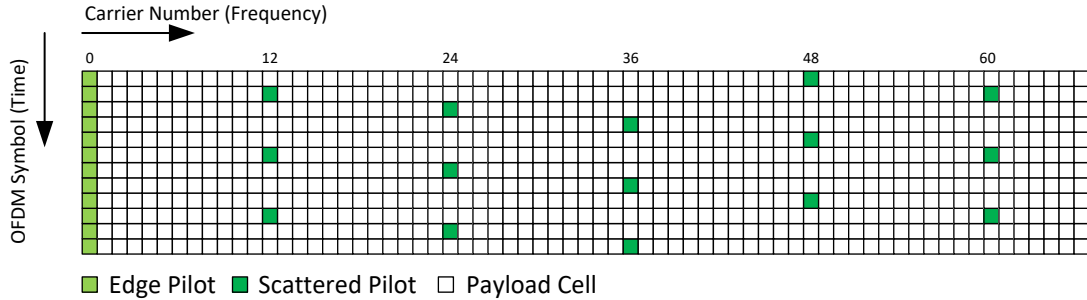

Figure E.1.10 Scattered pilot pattern SP12_4 (SISO, $D_X = 12$, $D_Y = 4$).

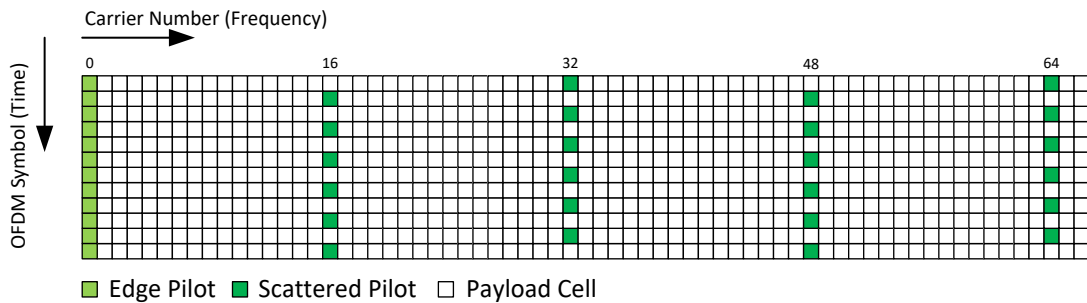

Figure E.1.11 Scattered pilot pattern SP16_2 (SISO, $D_X = 16$, $D_Y = 2$).

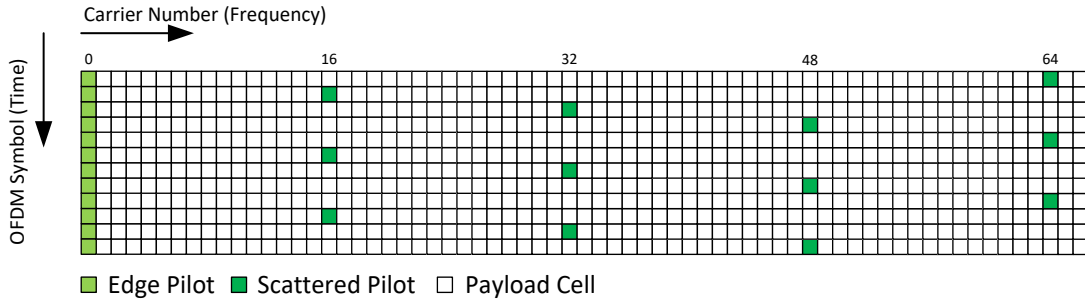

Figure E.1.12 Scattered pilot pattern SP16_4 (SISO, $D_X = 16$, $D_Y = 4$).

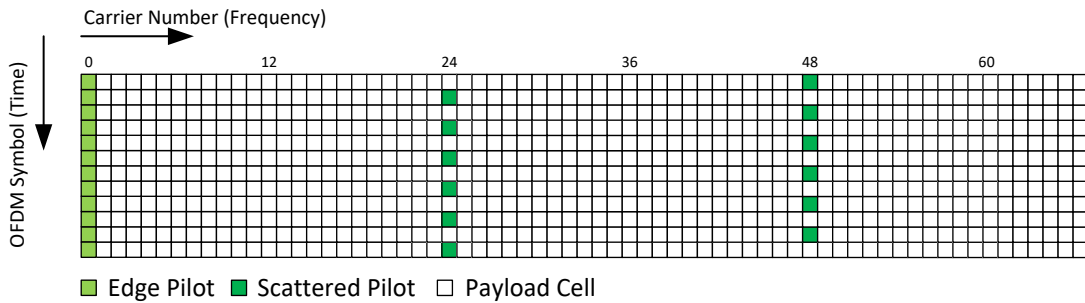

Figure E.1.13 Scattered pilot pattern SP24_2 (SISO, $D_X = 24$, $D_Y = 2$).

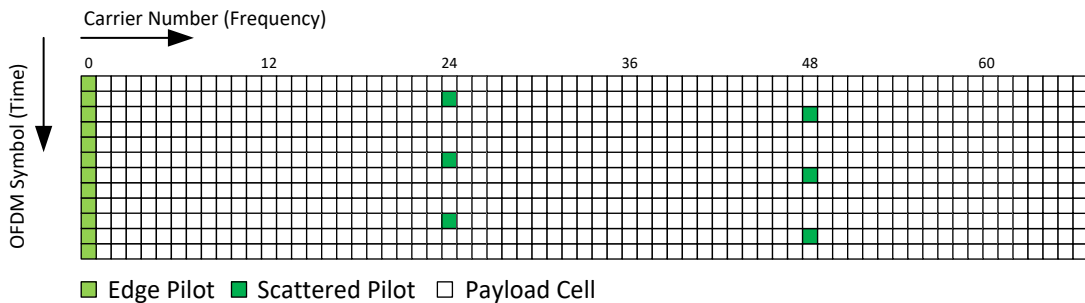

Figure E.1.14 Scattered pilot pattern SP24_4 (SISO, $D_X = 24$, $D_Y = 4$).

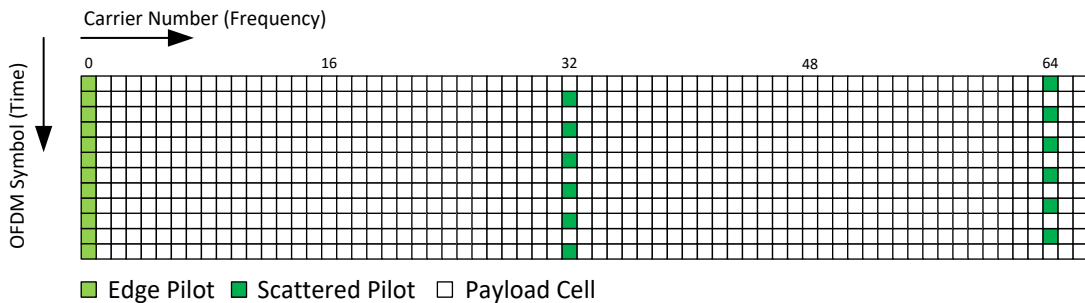

Figure E.1.15 Scattered pilot pattern SP32_2 (SISO, $D_X = 32$, $D_Y = 2$).

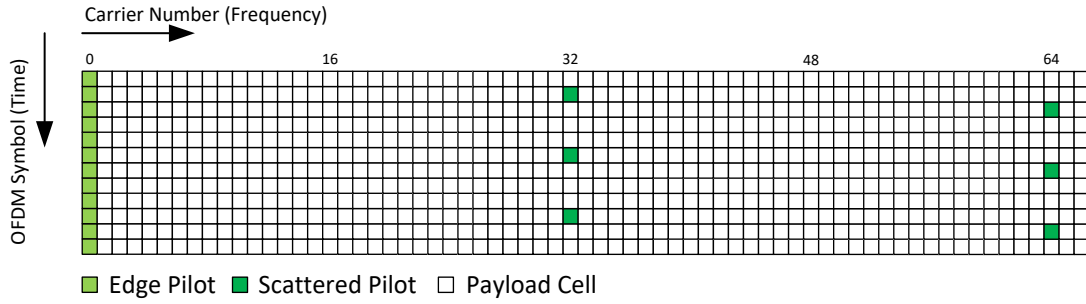

Figure E.1.16 Scattered pilot pattern SP32_4 (SISO, $D_X = 32$, $D_Y = 4$).

Annex F: Number of Active Data Cells in Subframe Boundary Symbol

F.1 SUBFRAME BOUNDARY SYMBOL ACTIVE DATA CELL TABLES

The number of active data cells in a Subframe boundary symbol (SBS) for various configurations shall be as listed below. Table entries shown in brackets and italicized are for FFT size and scattered pilot pattern combinations that are not allowed (refer to Table 8.3). Tone reservation is not configured in any of the tables in this Annex. When tone reservation is configured, refer to Section 7.2.6.4 to determine the number of active data cells in a Subframe boundary symbol. In the following tables **L1D_SPB** is shorthand for **L1D_scattered_pilot_boost**.

Table F.1.1 Number of Active Data Cells in a SBS when $C_{red_coeff}=0$

FFT Size	L1D_SPB	Active Data Cells in a Subframe Boundary Symbol							
		SP3_2	SP3_4	SP4_2	SP4_4	SP6_2	SP6_4	SP8_2	SP8_4
8K	0	4560	4560	5136	5136	5712	5712	6000	6000
	1	4560	3904	5009	4332	5456	4856	5716	5168
	2	4123	2922	4600	3467	5114	4147	5398	4558
	3	3801	2148	4278	2868	4843	3588	5188	4078
	4	3467	1534	4022	2245	4629	3146	4971	3697
16K	0	9120	9120	10272	10272	11424	11424	12000	12000
	1	9120	7807	10017	8663	10912	9708	11431	10331
	2	8244	5841	9199	6930	10225	8288	10793	9109
	3	7601	4290	8554	5731	9684	7168	10375	8146
	4	6933	3063	8043	4484	9256	6282	9939	7383
32K	0	18240	<i>(18240)</i>	<i>N/A</i>	<i>N/A</i>	22848	<i>(22848)</i>	24000	<i>(24000)</i>
	1	18240	<i>(15612)</i>	<i>N/A</i>	<i>N/A</i>	21823	<i>(19412)</i>	22861	<i>(20658)</i>
	2	16488	<i>(11678)</i>	<i>N/A</i>	<i>N/A</i>	20449	<i>(16570)</i>	21585	<i>(18212)</i>
	3	15202	<i>(8576)</i>	<i>N/A</i>	<i>N/A</i>	19367	<i>(14329)</i>	20747	<i>(16283)</i>
	4	13865	<i>(6121)</i>	<i>N/A</i>	<i>N/A</i>	18510	<i>(12555)</i>	19876	<i>(14755)</i>

Table F.1.2 Number of Active Data Cells in a SBS when $C_{red_coeff}=0$

FFT Size	L1D_SPB	Active Data Cells in a Subframe Boundary Symbol							
		SP12_2	SP12_4	SP16_2	SP16_4	SP24_2	SP24_4	SP32_2	SP32_4
8K	0	6288	6288	6432	6432	(6576)	(6576)	6648	6648
	1	5976	5508	6132	5691	(6297)	(5922)	6384	6064
	2	5729	5010	5919	5252	(6123)	(5564)	6231	5757
	3	5533	4616	5751	4906	(5986)	(5282)	6125	5515
	4	5379	4305	5618	4633	(5877)	(5058)	6015	5324
16K	0	12576	12576	12864	12864	13152	13152	13296	13296
	1	11950	11011	12262	11374	12593	11834	12766	12116
	2	11455	10010	11835	10493	12243	11113	12458	11497
	3	11064	9221	11499	9798	11968	10544	12245	11008
	4	10755	8596	11233	9248	11750	10094	12024	10622
32K	0	25152	(25152)	25728	(25728)	26304	(26304)	26592	(26592)
	1	23899	(22016)	24521	(22740)	25183	(23658)	25529	(24221)
	2	22907	(20010)	23667	(20974)	24483	(22211)	24913	(22976)
	3	22124	(18429)	22994	(19581)	23931	(21070)	24486	(21995)
	4	21505	(17177)	22461	(18479)	23494	(20167)	24042	(21218)

Table F.1.3 Number of Active Data Cells in a SBS when $C_{red_coeff}=1$

FFT Size	L1D_SPB	Active Data Cells in a Subframe Boundary Symbol							
		SP3_2	SP3_4	SP4_2	SP4_4	SP6_2	SP6_4	SP8_2	SP8_4
8K	0	4496	4496	5064	5064	5632	5632	5916	5916
	1	4496	3849	4938	4272	5380	4788	5636	5096
	2	4065	2881	4535	3419	5042	4089	5322	4494
	3	3748	2117	4218	2828	4775	3538	5116	4021
	4	3418	1513	3966	2214	4564	3102	4901	3645
16K	0	8992	8992	10128	10128	11264	11264	11832	11832
	1	8992	7697	9876	8541	10759	9572	11271	10187
	2	8129	5758	9070	6833	10082	8171	10642	8982
	3	7495	4229	8434	5650	9549	7068	10229	8032
	4	6835	3019	7930	4420	9126	6194	9800	7280
32K	0	17984	(17984)	N/A	N/A	22528	(22528)	23664	(23664)
	1	17984	(15393)	N/A	N/A	21517	(19140)	22541	(20369)
	2	16256	(11513)	N/A	N/A	20163	(16337)	21282	(17956)
	3	14988	(8454)	N/A	N/A	19095	(14127)	20456	(16054)
	4	13669	(6033)	N/A	N/A	18250	(12378)	19597	(14548)

Table F.1.4 Number of Active Data Cells in a SBS when $C_{red_coeff}=1$

FFT Size	L1D_SPB	Active Data Cells in a Subframe Boundary Symbol							
		SP12_2	SP12_4	SP16_2	SP16_4	SP24_2	SP24_4	SP32_2	SP32_4
8K	0	6200	6200	6342	6342	(6484)	(6484)	6555	6555
	1	5892	5431	6046	5608	(6209)	(5839)	6294	5971
	2	5648	4940	5836	5173	(6038)	(5486)	6142	5664
	3	5456	4552	5671	4831	(5902)	(5208)	6037	5422
	4	5304	4245	5540	4559	(5795)	(4988)	5928	5231
16K	0	12400	12400	12684	12684	12968	12968	13110	13110
	1	11783	10857	12090	11215	12416	11668	12587	11941
	2	11294	9870	11669	10346	12072	10957	12284	11327
	3	10909	9091	11338	9661	11800	10397	12074	10844
	4	10604	8475	11075	9118	11585	9953	11856	10461
32K	0	24800	(24800)	25368	(25368)	25936	(25936)	26220	(26220)
	1	23564	(21707)	24178	(22422)	24830	(23327)	25172	(23882)
	2	22586	(19730)	23336	(20680)	24140	(21900)	24564	(22654)
	3	21815	(18170)	22672	(19307)	23596	(20775)	24143	(21687)
	4	21204	(16936)	22146	(18220)	23165	(19885)	23705	(20921)

Table F.1.5 Number of Active Data Cells in a SBS when $C_{red_coeff}=2$

FFT Size	L1D_SPB	Active Data Cells in a Subframe Boundary Symbol							
		SP3_2	SP3_4	SP4_2	SP4_4	SP6_2	SP6_4	SP8_2	SP8_4
8K	0	4433	4433	4993	4993	5553	5553	5833	5833
	1	4433	3796	4869	4212	5304	4720	5557	5024
	2	4008	2841	4472	3371	4971	4032	5247	4432
	3	3695	2088	4158	2788	4708	3488	5044	3964
	4	3371	1492	3910	2183	4500	3058	4833	3595
16K	0	8867	8867	9987	9987	11107	11107	11667	11667
	1	8867	7591	9739	8422	10609	9438	11114	10045
	2	8016	5679	8943	6738	9942	8058	10494	8857
	3	7391	4172	8316	5572	9416	6970	10087	7920
	4	6741	2979	7820	4360	8999	6108	9664	7179
32K	0	17734	(17734)	N/A	N/A	22214	(22214)	23334	(23334)
	1	17734	(15179)	N/A	N/A	21217	(18873)	22227	(20085)
	2	16031	(11354)	N/A	N/A	19882	(16110)	20986	(17707)
	3	14780	(8339)	N/A	N/A	18829	(13932)	20171	(15831)
	4	13480	(5951)	N/A	N/A	17996	(12207)	19324	(14347)

Table F.1.6 Number of Active Data Cells in a SBS when $C_{red_coeff}=2$

FFT Size	L1D_SPB	Active Data Cells in a Subframe Boundary Symbol							
		SP12_2	SP12_4	SP16_2	SP16_4	SP24_2	SP24_4	SP32_2	SP32_4
8K	0	6113	6113	6253	6253	(6393)	(6393)	6463	6463
	1	5810	5355	5961	5532	(6122)	(5757)	6207	5890
	2	5569	4870	5754	5106	(5953)	(5409)	6058	5589
	3	5380	4488	5591	4770	(5820)	(5135)	5955	5351
	4	5229	4186	5462	4504	(5714)	(4918)	5848	5164
16K	0	12227	12227	12507	12507	12787	12787	12927	12927
	1	11619	10706	11921	11058	12243	11506	12412	11780
	2	11137	9732	11507	10202	11903	10805	12113	11178
	3	10757	8965	11180	9526	11636	10252	11906	10703
	4	10456	8358	10921	8992	11424	9815	11691	10328
32K	0	24454	(24454)	25014	(25014)	25574	(25574)	25854	(25854)
	1	23236	(21405)	23841	(22109)	24484	(23002)	24821	(23549)
	2	22271	(19455)	23011	(20392)	23803	(21595)	24221	(22339)
	3	21511	(17918)	22356	(19038)	23267	(20486)	23806	(21385)
	4	20909	(16701)	21838	(17967)	22842	(19608)	23375	(20630)

Table F.1.7 Number of Active Data Cells in a SBS when $C_{red_coeff}=3$

FFT Size	L1D_SPB	Active Data Cells in a Subframe Boundary Symbol							
		SP3_2	SP3_4	SP4_2	SP4_4	SP6_2	SP6_4	SP8_2	SP8_4
8K	0	4370	4370	4922	4922	5474	5474	5750	5750
	1	4370	3742	4800	4152	5229	4653	5478	4953
	2	3951	2800	4408	3323	4901	3974	5173	4369
	3	3643	2058	4099	2749	4641	3439	4972	3908
	4	3323	1471	3855	2152	4436	3015	4764	3544
16K	0	8740	8740	9844	9844	10948	10948	11500	11500
	1	8740	7482	9599	8302	10457	9303	10955	9901
	2	7901	5597	8815	6642	9799	7943	10344	8730
	3	7285	4112	8197	5492	9281	6870	9942	7807
	4	6644	2936	7708	4297	8870	6021	9525	7076
32K	0	17480	(17480)	N/A	N/A	21896	(21896)	23000	(23000)
	1	17480	(14962)	N/A	N/A	20913	(18603)	21909	(19798)
	2	15801	(11192)	N/A	N/A	19597	(15879)	20685	(17453)
	3	14568	(8219)	N/A	N/A	18560	(13732)	19882	(15604)
	4	13287	(5866)	N/A	N/A	17738	(12032)	19048	(14141)

Table F.1.8 Number of Active Data Cells in a SBS when $C_{red_coeff}=3$

FFT Size	L1D_SPB	Active Data Cells in a Subframe Boundary Symbol							
		SP12_2	SP12_4	SP16_2	SP16_4	SP24_2	SP24_4	SP32_2	SP32_4
8K	0	6026	6026	6164	6164	(6302)	(6302)	6371	6371
	1	5727	5279	5876	5450	(6035)	(5675)	6117	5809
	2	5490	4801	5672	5028	(5868)	(5333)	5970	5514
	3	5303	4425	5512	4695	(5737)	(5062)	5868	5281
	4	5155	4126	5385	4432	(5633)	(4848)	5762	5097
16K	0	12052	12052	12328	12328	12604	12604	12742	12742
	1	11452	10552	11751	10900	12068	11341	12234	11606
	2	10977	9593	11342	10056	11733	10650	11940	11010
	3	10603	8837	11020	9390	11469	10106	11735	10540
	4	10307	8238	10765	8863	11260	9675	11523	10168
32K	0	24104	(24104)	24656	(24656)	25208	(25208)	25484	(25484)
	1	22903	(21099)	23500	(21793)	24133	(22673)	24465	(23212)
	2	21952	(19177)	22681	(20100)	23463	(21286)	23875	(22019)
	3	21203	(17661)	22036	(18766)	22934	(20193)	23466	(21079)
	4	20609	(16462)	21525	(17710)	22515	(19328)	23040	(20335)

Table F.1.9 Number of Active Data Cells in a SBS when $C_{red_coeff}=4$

FFT Size	L1D_SPB	Active Data Cells in a Subframe Boundary Symbol							
		SP3_2	SP3_4	SP4_2	SP4_4	SP6_2	SP6_4	SP8_2	SP8_4
8K	0	4307	4307	4851	4851	5395	5395	5667	5667
	1	4307	3688	4731	4092	5154	4586	5399	4881
	2	3894	2760	4345	3275	4830	3917	5098	4306
	3	3591	2029	4040	2710	4575	3390	4901	3852
	4	3275	1450	3799	2121	4372	2972	4695	3493
16K	0	8614	8614	9702	9702	10790	10790	11334	11334
	1	8614	7374	9461	8182	10306	9169	10797	9758
	2	7787	5517	8688	6546	9658	7828	10194	8604
	3	7180	4053	8079	5413	9147	6771	9799	7695
	4	6549	2894	7597	4236	8743	5934	9388	6974
32K	0	17228	(17228)	N/A	N/A	21580	(21580)	22668	(22668)
	1	17228	(14746)	N/A	N/A	20612	(18335)	21593	(19512)
	2	15573	(11031)	N/A	N/A	19315	(15651)	20387	(17202)
	3	14359	(8101)	N/A	N/A	18292	(13534)	19596	(15380)
	4	13096	(5782)	N/A	N/A	17483	(11859)	18773	(13938)

Table F.1.10 Number of Active Data Cells in a SBS when $C_{red_coeff}=4$

FFT Size	L1D_SPB	Active Data Cells in a Subframe Boundary Symbol							
		SP12_2	SP12_4	SP16_2	SP16_4	SP24_2	SP24_4	SP32_2	SP32_4
8K	0	5939	5939	6075	6075	(6211)	(6211)	6279	6279
	1	5644	5203	5792	5375	(5948)	(5594)	6030	5728
	2	5411	4732	5591	4961	(5784)	(5256)	5886	5438
	3	5227	4361	5432	4635	(5654)	(4990)	5786	5210
	4	5081	4067	5307	4377	(5552)	(4779)	5682	5030
16K	0	11878	11878	12150	12150	12422	12422	12558	12558
	1	11287	10400	11581	10743	11894	11178	12058	11444
	2	10819	9455	11178	9911	11564	10497	11767	10860
	3	10450	8710	10861	9255	11304	9960	11566	10399
	4	10158	8120	10609	8736	11098	9536	11357	10034
32K	0	23756	(23756)	24300	(24300)	24844	(24844)	25116	(25116)
	1	22572	(20794)	23160	(21478)	23785	(22345)	24112	(22877)
	2	21636	(18900)	22354	(19810)	23124	(20979)	23530	(21702)
	3	20897	(17407)	21718	(18495)	22603	(19902)	23127	(20775)
	4	20312	(16225)	21215	(17454)	22190	(19049)	22708	(20042)

F.2 CALCULATION OF SUBFRAME BOUNDARY SYMBOL NULL CELLS (INFORMATIVE)

The number of null cells in a Subframe boundary symbol can be calculated as follows:

$$N_{Null}^B = N_{Data}^B - N_C^B$$

where

$$N_C^B = \text{ceil} (N_C^D - (N_{SP}^{SBS} - \text{NoC} + N_C^D + N_{NSP}^{CP}) * (A_{SP})^2)$$

with the terms used explained as follows:

NoC total number of active carriers

N_C^D number of active data cells in a data symbol

N_C^B number of active data cells in a Subframe boundary symbol

N_{Null}^B number of null cells in a Subframe boundary symbol

N_{Data}^B total number of data cells (non-pilot cells) including both null and active data cells in a Subframe boundary symbol

A_{SP} scattered pilot amplitude

N_{SP}^{SBS} number of Subframe boundary pilots in a Subframe boundary symbol

N_{NSP}^{CP} number of common continual pilots

Annex G: Tone Reservation Carrier Indices

G.1 TONE RESERVATION CARRIER INDICES

When tone reservation is used, the set of reserved carriers for PAPR reduction in all symbols (except the first Preamble symbol) depends on the type of symbol and D_x . Table G.1.1 shows the table indices corresponding to the set of reserved carriers for PAPR reduction according to each type of symbol. Tone reservation shall never be applied to the first Preamble symbol.

Table G.1.1 Table Indices Corresponding to the Set of Reserved Carriers for PAPR Reduction According to Each Type of Symbol

Symbol Index	Preamble Symbol		Subframe Boundary Symbol		Data Symbol
	$I = 0$	$0 < I < N_P$			
D_x	All	3, 4, 8	6, 12, 16, 24, 32	3, 4, 8	6, 12, 16, 24, 32
Set of carriers reserved for PAPR reduction	N/A	Table G.1.3	Table G.1.2	Table G.1.3	Table G.1.2

Carrier indices specified in this Annex represent absolute carrier indices. Absolute carrier indices are indexed on the maximum possible number of carriers regardless of whether carrier reduction has been configured and hence range from 0 to $NoC_{max} - 1$.

Table G.1.2 Set of Carriers Reserved for PAPR reduction for All Symbols Except the First Preamble Symbol, the Other ($N_P - 1$) Preamble Symbols of $D_X = 3$, $D_X = 4$, and $D_X = 8$, and Subframe Boundary Symbols of $D_X = 3$, $D_X = 4$, and $D_X = 8$

FFT (# of Reserved tones)	TR Carrier Indices
8k (72)	250, 386, 407, 550, 591, 717, 763, 787, 797, 839, 950, 1090, 1105, 1199, 1738, 1867, 1903, 1997, 2114, 2260, 2356, 2427, 2428, 2444, 2452, 2475, 2564, 2649, 2663, 2678, 2740, 2777, 2819, 2986, 3097, 3134, 3253, 3284, 3323, 3442, 3596, 3694, 3719, 3751, 3763, 3836, 4154, 4257, 4355, 4580, 4587, 4678, 4805, 5084, 5126, 5161, 5229, 5321, 5445, 5649, 5741, 5746, 5885, 5918, 6075, 6093, 6319, 6421, 6463, 6511, 6517, 6577
16k (144)	421, 548, 589, 621, 644, 727, 770, 813, 857, 862, 1113, 1187, 1201, 1220, 1393, 1517, 1821, 1899, 1924, 2003, 2023, 2143, 2146, 2290, 2474, 2482, 2597, 2644, 2749, 2818, 2951, 3014, 3212, 3237, 3363, 3430, 3515, 3517, 3745, 3758, 4049, 4165, 4354, 4399, 4575, 4763, 4789, 4802, 4834, 4970, 5260, 5386, 5395, 5402, 5579, 5716, 5734, 5884, 5895, 6073, 6123, 6158, 6212, 6243, 6521, 6593, 6604, 6607, 6772, 6842, 6908, 6986, 7220, 7331, 7396, 7407, 7588, 7635, 7665, 7893, 7925, 7949, 8019, 8038, 8167, 8289, 8295, 8338, 8549, 8555, 8660, 8857, 8925, 9007, 9057, 9121, 9364, 9375, 9423, 9446, 9479, 9502, 9527, 9860, 9919, 9938, 10138, 10189, 10191, 10275, 10333, 10377, 10988, 11109, 11261, 11266, 11362, 11390, 11534, 11623, 11893, 11989, 12037, 12101, 12119, 12185, 12254, 12369, 12371, 12380, 12401, 12586, 12597, 12638, 12913, 12974, 13001, 13045, 13052, 13111, 13143, 13150, 13151, 13300
32K (288)	803, 805, 811, 901, 1001, 1027, 1245, 1258, 1318, 1478, 1507, 1509, 1556, 1577, 1655, 1742, 1978, 2001, 2056, 2110, 2164, 2227, 2305, 2356, 2408, 2522, 2563, 2780, 2805, 2879, 3010, 3019, 3128, 3389, 3649, 3730, 3873, 4027, 4066, 4087, 4181, 4246, 4259, 4364, 4406, 4515, 4690, 4773, 4893, 4916, 4941, 4951, 4965, 5165, 5222, 5416, 5638, 5687, 5729, 5930, 5997, 6005, 6161, 6218, 6292, 6344, 6370, 6386, 6505, 6974, 7079, 7114, 7275, 7334, 7665, 7765, 7868, 7917, 7966, 8023, 8055, 8089, 8091, 8191, 8374, 8495, 8651, 8690, 8755, 8821, 9139, 9189, 9274, 9561, 9611, 9692, 9711, 9782, 9873, 9964, 10011, 10209, 10575, 10601, 10623, 10690, 10967, 11045, 11083, 11084, 11090, 11128, 11153, 11530, 11737, 11829, 11903, 11907, 11930, 11942, 12356, 12429, 12484, 12547, 12562, 12605, 12767, 12863, 13019, 13052, 13053, 13167, 13210, 13244, 13259, 13342, 13370, 13384, 13447, 13694, 13918, 14002, 14077, 14111, 14216, 14243, 14270, 14450, 14451, 14456, 14479, 14653, 14692, 14827, 14865, 14871, 14908, 15215, 15227, 15284, 15313, 15333, 15537, 15643, 15754, 15789, 16065, 16209, 16213, 16217, 16259, 16367, 16369, 16646, 16780, 16906, 16946, 17012, 17167, 17192, 17325, 17414, 17629, 17687, 17746, 17788, 17833, 17885, 17913, 18067, 18089, 18316, 18337, 18370, 18376, 18440, 18550, 18680, 18910, 18937, 19047, 19052, 19117, 19383, 19396, 19496, 19601, 19778, 19797, 20038, 20357, 20379, 20455, 20669, 20707, 20708, 20751, 20846, 20853, 20906, 21051, 21079, 21213, 21267, 21308, 21355, 21523, 21574, 21815, 21893, 21973, 22084, 22172, 22271, 22713, 22905, 23039, 23195, 23303, 23635, 23732, 23749, 23799, 23885, 23944, 24149, 24311, 24379, 24471, 24553, 24585, 24611, 24616, 24621, 24761, 24789, 24844, 24847, 24977, 25015, 25160, 25207, 25283, 25351, 25363, 25394, 25540, 25603, 25647, 25747, 25768, 25915, 25928, 26071, 26092, 26139, 26180, 26209, 26270, 26273, 26278, 26326, 26341, 26392, 26559, 26642, 26776, 26842

Table G.1.3 Set of Carriers Reserved for PAPR reduction in Preamble Symbols of $D_X=3$, $D_X=4$, and $D_X=8$ Except the First Preamble Symbol and in Subframe Boundary Symbols of $D_X=3$, $D_X=4$, and $D_X=8$

FFT Size	TR Carrier Indices
8k (72)	295, 329, 347, 365, 463, 473, 481, 553, 578, 602, 742, 749, 829, 922, 941, 1115, 1123, 1174, 1363, 1394, 1402, 1615, 1657, 1702, 1898, 1910, 1997, 2399, 2506, 2522, 2687, 2735, 3043, 3295, 3389, 3454, 3557, 3647, 3719, 3793, 3794, 3874, 3898, 3970, 4054, 4450, 4609, 4666, 4829, 4855, 4879, 4961, 4969, 5171, 5182, 5242, 5393, 5545, 5567, 5618, 5630, 5734, 5861, 5897, 5987, 5989, 6002, 6062, 6074, 6205, 6334, 6497
16k (144)	509, 739, 770, 890, 970, 989, 1031, 1033, 1121, 1223, 1231, 1285, 1526, 1559, 1603, 1615, 1690, 1771, 1903, 1910, 1958, 2033, 2146, 2225, 2302, 2306, 2345, 2447, 2477, 2561, 2578, 2597, 2635, 2654, 2687, 2891, 2938, 3029, 3271, 3479, 3667, 3713, 3791, 3977, 4067, 4150, 4217, 4387, 4501, 4541, 4657, 4733, 4742, 4963, 5011, 5149, 5311, 5362, 5491, 5531, 5609, 5722, 5747, 5798, 5842, 5881, 5959, 5983, 6059, 6166, 6178, 6214, 6230, 6382, 6557, 6625, 6811, 6881, 6994, 7261, 7535, 7546, 7711, 7897, 7898, 7918, 7997, 8125, 8398, 8483, 8530, 8686, 8731, 8855, 9001, 9026, 9110, 9206, 9223, 9325, 9466, 9493, 9890, 9893, 10537, 10570, 10691, 10835, 10837, 11098, 11126, 11146, 11198, 11270, 11393, 11629, 11657, 11795, 11867, 11909, 11983, 12046, 12107, 12119, 12353, 12482, 12569, 12575, 12662, 12691, 12739, 12787, 12902, 12917, 12985, 13010, 13022, 13073, 13102, 13141, 13159, 13225, 13255, 13303
32K (288)	793, 884, 899, 914, 1004, 1183, 1198, 1276, 1300, 1339, 1348, 1444, 1487, 1490, 1766, 1870, 1903, 1909, 1961, 2053, 2092, 2099, 2431, 2572, 2578, 2618, 2719, 2725, 2746, 2777, 2798, 2891, 2966, 2972, 3023, 3037, 3076, 3257, 3284, 3326, 3389, 3425, 3454, 3523, 3602, 3826, 3838, 3875, 3955, 4094, 4126, 4261, 4349, 4357, 4451, 4646, 4655, 4913, 5075, 5083, 5306, 5317, 5587, 5821, 6038, 6053, 6062, 6137, 6268, 6286, 6490, 6517, 6529, 6554, 6593, 6671, 6751, 6827, 6845, 7043, 7111, 7147, 7196, 7393, 7451, 7475, 7517, 7750, 7769, 7780, 8023, 8081, 8263, 8290, 8425, 8492, 8939, 8986, 9113, 9271, 9298, 9343, 9455, 9476, 9637, 9821, 9829, 9913, 9953, 9988, 10001, 10007, 10018, 10082, 10172, 10421, 10553, 10582, 10622, 10678, 10843, 10885, 10901, 11404, 11674, 11959, 12007, 12199, 12227, 12290, 12301, 12629, 12631, 12658, 12739, 12866, 12977, 13121, 13294, 13843, 13849, 13852, 13933, 14134, 14317, 14335, 14342, 14407, 14651, 14758, 14815, 14833, 14999, 15046, 15097, 15158, 15383, 15503, 15727, 15881, 16139, 16238, 16277, 16331, 16444, 16490, 16747, 16870, 16981, 17641, 17710, 17714, 17845, 18011, 18046, 18086, 18097, 18283, 18334, 18364, 18431, 18497, 18527, 18604, 18686, 18709, 18731, 18740, 18749, 18772, 18893, 19045, 19075, 19087, 19091, 19099, 19127, 19169, 19259, 19427, 19433, 19450, 19517, 19526, 19610, 19807, 19843, 19891, 20062, 20159, 20246, 20420, 20516, 20530, 20686, 20801, 20870, 20974, 21131, 21158, 21565, 21635, 21785, 21820, 21914, 21926, 22046, 22375, 22406, 22601, 22679, 22699, 22772, 22819, 22847, 22900, 22982, 22987, 23063, 23254, 23335, 23357, 23561, 23590, 23711, 23753, 23902, 24037, 24085, 24101, 24115, 24167, 24182, 24361, 24374, 24421, 24427, 24458, 24463, 24706, 24748, 24941, 25079, 25127, 25195, 25285, 25444, 25492, 25505, 25667, 25682, 25729, 25741, 25765, 25973, 26171, 26180, 26227, 26353, 26381, 26542, 26603, 26651, 26671, 26759, 26804, 26807, 26827

Annex H: Preamble Parameters for Bootstrap

H.1 PREAMBLE STRUCTURE PARAMETER VALUES

The allowed values for **preamble_structure** and corresponding preamble parameter values shall be as shown in Table H.1.1. Note that in the present release of the specification the defined **preamble_structure** values do not make use of L1-Basic Modes 6 and 7.

Table H.1.1 Meaning of Signaled Values of **preamble_structure**

preamble_structure	FFT Size	GI Length (samples)	Preamble Pilot D_x	L1-Basic FEC Mode
0	8K	192	16	L1-Basic Mode 1
1	8K	192	16	L1-Basic Mode 2
2	8K	192	16	L1-Basic Mode 3
3	8K	192	16	L1-Basic Mode 4
4	8K	192	16	L1-Basic Mode 5
5	8K	384	8	L1-Basic Mode 1
6	8K	384	8	L1-Basic Mode 2
7	8K	384	8	L1-Basic Mode 3
8	8K	384	8	L1-Basic Mode 4
9	8K	384	8	L1-Basic Mode 5
10	8K	512	6	L1-Basic Mode 1
11	8K	512	6	L1-Basic Mode 2
12	8K	512	6	L1-Basic Mode 3
13	8K	512	6	L1-Basic Mode 4
14	8K	512	6	L1-Basic Mode 5
15	8K	768	4	L1-Basic Mode 1
16	8K	768	4	L1-Basic Mode 2
17	8K	768	4	L1-Basic Mode 3
18	8K	768	4	L1-Basic Mode 4
19	8K	768	4	L1-Basic Mode 5
20	8K	1024	3	L1-Basic Mode 1
21	8K	1024	3	L1-Basic Mode 2
22	8K	1024	3	L1-Basic Mode 3
23	8K	1024	3	L1-Basic Mode 4
24	8K	1024	3	L1-Basic Mode 5
25	8K	1536	4	L1-Basic Mode 1
26	8K	1536	4	L1-Basic Mode 2
27	8K	1536	4	L1-Basic Mode 3
28	8K	1536	4	L1-Basic Mode 4
29	8K	1536	4	L1-Basic Mode 5
30	8K	2048	3	L1-Basic Mode 1
31	8K	2048	3	L1-Basic Mode 2

32	8K	2048	3	L1-Basic Mode 3
33	8K	2048	3	L1-Basic Mode 4
34	8K	2048	3	L1-Basic Mode 5
35	16K	192	32	L1-Basic Mode 1
36	16K	192	32	L1-Basic Mode 2
37	16K	192	32	L1-Basic Mode 3
38	16K	192	32	L1-Basic Mode 4
39	16K	192	32	L1-Basic Mode 5
40	16K	384	16	L1-Basic Mode 1
41	16K	384	16	L1-Basic Mode 2
42	16K	384	16	L1-Basic Mode 3
43	16K	384	16	L1-Basic Mode 4
44	16K	384	16	L1-Basic Mode 5
45	16K	512	12	L1-Basic Mode 1
46	16K	512	12	L1-Basic Mode 2
47	16K	512	12	L1-Basic Mode 3
48	16K	512	12	L1-Basic Mode 4
49	16K	512	12	L1-Basic Mode 5
50	16K	768	8	L1-Basic Mode 1
51	16K	768	8	L1-Basic Mode 2
52	16K	768	8	L1-Basic Mode 3
53	16K	768	8	L1-Basic Mode 4
54	16K	768	8	L1-Basic Mode 5
55	16K	1024	6	L1-Basic Mode 1
56	16K	1024	6	L1-Basic Mode 2
57	16K	1024	6	L1-Basic Mode 3
58	16K	1024	6	L1-Basic Mode 4
59	16K	1024	6	L1-Basic Mode 5
60	16K	1536	4	L1-Basic Mode 1
61	16K	1536	4	L1-Basic Mode 2
62	16K	1536	4	L1-Basic Mode 3
63	16K	1536	4	L1-Basic Mode 4
64	16K	1536	4	L1-Basic Mode 5
65	16K	2048	3	L1-Basic Mode 1
66	16K	2048	3	L1-Basic Mode 2
67	16K	2048	3	L1-Basic Mode 3
68	16K	2048	3	L1-Basic Mode 4
69	16K	2048	3	L1-Basic Mode 5
70	16K	2432	3	L1-Basic Mode 1
71	16K	2432	3	L1-Basic Mode 2
72	16K	2432	3	L1-Basic Mode 3
73	16K	2432	3	L1-Basic Mode 4
74	16K	2432	3	L1-Basic Mode 5
75	16K	3072	4	L1-Basic Mode 1
76	16K	3072	4	L1-Basic Mode 2
77	16K	3072	4	L1-Basic Mode 3
78	16K	3072	4	L1-Basic Mode 4

79	16K	3072	4	L1-Basic Mode 5
80	16K	3648	4	L1-Basic Mode 1
81	16K	3648	4	L1-Basic Mode 2
82	16K	3648	4	L1-Basic Mode 3
83	16K	3648	4	L1-Basic Mode 4
84	16K	3648	4	L1-Basic Mode 5
85	16K	4096	3	L1-Basic Mode 1
86	16K	4096	3	L1-Basic Mode 2
87	16K	4096	3	L1-Basic Mode 3
88	16K	4096	3	L1-Basic Mode 4
89	16K	4096	3	L1-Basic Mode 5
90	32K	192	32	L1-Basic Mode 1
91	32K	192	32	L1-Basic Mode 2
92	32K	192	32	L1-Basic Mode 3
93	32K	192	32	L1-Basic Mode 4
94	32K	192	32	L1-Basic Mode 5
95	32K	384	32	L1-Basic Mode 1
96	32K	384	32	L1-Basic Mode 2
97	32K	384	32	L1-Basic Mode 3
98	32K	384	32	L1-Basic Mode 4
99	32K	384	32	L1-Basic Mode 5
100	32K	512	24	L1-Basic Mode 1
101	32K	512	24	L1-Basic Mode 2
102	32K	512	24	L1-Basic Mode 3
103	32K	512	24	L1-Basic Mode 4
104	32K	512	24	L1-Basic Mode 5
105	32K	768	16	L1-Basic Mode 1
106	32K	768	16	L1-Basic Mode 2
107	32K	768	16	L1-Basic Mode 3
108	32K	768	16	L1-Basic Mode 4
109	32K	768	16	L1-Basic Mode 5
110	32K	1024	12	L1-Basic Mode 1
111	32K	1024	12	L1-Basic Mode 2
112	32K	1024	12	L1-Basic Mode 3
113	32K	1024	12	L1-Basic Mode 4
114	32K	1024	12	L1-Basic Mode 5
115	32K	1536	8	L1-Basic Mode 1
116	32K	1536	8	L1-Basic Mode 2
117	32K	1536	8	L1-Basic Mode 3
118	32K	1536	8	L1-Basic Mode 4
119	32K	1536	8	L1-Basic Mode 5
120	32K	2048	6	L1-Basic Mode 1
121	32K	2048	6	L1-Basic Mode 2
122	32K	2048	6	L1-Basic Mode 3
123	32K	2048	6	L1-Basic Mode 4
124	32K	2048	6	L1-Basic Mode 5
125	32K	2432	6	L1-Basic Mode 1

126	32K	2432	6	L1-Basic Mode 2
127	32K	2432	6	L1-Basic Mode 3
128	32K	2432	6	L1-Basic Mode 4
129	32K	2432	6	L1-Basic Mode 5
130	32K	3072	8	L1-Basic Mode 1
131	32K	3072	8	L1-Basic Mode 2
132	32K	3072	8	L1-Basic Mode 3
133	32K	3072	8	L1-Basic Mode 4
134	32K	3072	8	L1-Basic Mode 5
135	32K	3072	3	L1-Basic Mode 1
136	32K	3072	3	L1-Basic Mode 2
137	32K	3072	3	L1-Basic Mode 3
138	32K	3072	3	L1-Basic Mode 4
139	32K	3072	3	L1-Basic Mode 5
140	32K	3648	8	L1-Basic Mode 1
141	32K	3648	8	L1-Basic Mode 2
142	32K	3648	8	L1-Basic Mode 3
143	32K	3648	8	L1-Basic Mode 4
144	32K	3648	8	L1-Basic Mode 5
145	32K	3648	3	L1-Basic Mode 1
146	32K	3648	3	L1-Basic Mode 2
147	32K	3648	3	L1-Basic Mode 3
148	32K	3648	3	L1-Basic Mode 4
149	32K	3648	3	L1-Basic Mode 5
150	32K	4096	3	L1-Basic Mode 1
151	32K	4096	3	L1-Basic Mode 2
152	32K	4096	3	L1-Basic Mode 3
153	32K	4096	3	L1-Basic Mode 4
154	32K	4096	3	L1-Basic Mode 5
155	32K	4864	3	L1-Basic Mode 1
156	32K	4864	3	L1-Basic Mode 2
157	32K	4864	3	L1-Basic Mode 3
158	32K	4864	3	L1-Basic Mode 4
159	32K	4864	3	L1-Basic Mode 5
160-255	Reserved	Reserved	Reserved	Reserved

Annex I: Total Symbol Power

I.1 PREAMBLE SYMBOL FREQUENCY DOMAIN POWER

The following tables describe the total frequency domain power in Preamble symbols.

Table I.1.1 Frequency Domain Total Power of the Preamble Symbol ($P_{\text{Preamble},l}$)

FFT Size	GI Length (samples)	Pilot Pattern (D_x)	P_{Preamble} (FD total power)				
			Cred_coeff 0	Cred_coeff 1	Cred_coeff 2	Cred_coeff 3	Cred_coeff 4
8K	192	16	8240.53	8130.20	8013.76	7897.31	7780.87
8K	384	8	8322.93	8211.44	8093.84	7976.24	7858.64
8K	512	6	8301.50	8190.31	8073.00	7955.69	7838.38
8K	768	4	8094.28	7985.96	7871.52	7757.08	7642.65
8K	1024	3	7737.10	7633.73	7524.25	7414.77	7305.30
8K	1536	4	8094.28	7985.96	7871.52	7757.08	7642.65
8K	2048	3	7737.10	7633.73	7524.25	7414.77	7305.30
16K	192	32	16051.13	15836.42	15603.37	15382.54	15155.60
16K	384	16	16477.67	16257.01	16018.01	15791.24	15558.36
16K	512	12	16583.95	16361.81	16121.33	15893.08	15658.71
16K	768	8	16643.58	16420.60	16179.28	15950.19	15714.99
16K	1024	6	16601.06	16378.66	16137.94	15909.43	15674.81
16K	1536	4	16561.26	16339.42	16099.24	15871.28	15637.21
16K	2048	3	16020.04	15805.70	15573.04	15352.59	15126.04
16K	2432	3	16020.04	15805.70	15573.04	15352.59	15126.04
16K	3072	4	16561.26	16339.42	16099.24	15871.28	15637.21
16K	3648	4	16561.26	16339.42	16099.24	15871.28	15637.21
16K	4096	3	16020.04	15805.70	15573.04	15352.59	15126.04
32K	192	32	32097.48	31668.05	31201.95	30760.29	30306.41
32K	384	32	32097.48	31668.05	31201.95	30760.29	30306.41
32K	512	24	32475.84	32041.14	31569.77	31122.85	30663.71
32K	768	16	32951.95	32510.63	32032.64	31579.09	31113.33
32K	1024	12	33165.03	32720.74	32239.78	31783.27	31314.54
32K	1536	8	34048.92	33592.35	33099.12	32630.32	32149.31
32K	2048	6	33842.90	33389.18	32898.80	32432.87	31954.71
32K	2432	6	33842.90	33389.18	32898.80	32432.87	31954.71
32K	3072	8	34048.92	33592.35	33099.12	32630.32	32149.31
32K	3072	3	32038.72	31610.06	31144.72	30703.83	30250.72
32K	3648	8	34048.92	33592.35	33099.12	32630.32	32149.31
32K	3648	3	32038.72	31610.06	31144.72	30703.83	30250.72
32K	4096	3	32038.72	31610.06	31144.72	30703.83	30250.72
32K	4864	3	32038.72	31610.06	31144.72	30703.83	30250.72

I.2 DATA AND SUBFRAME BOUNDARY SYMBOL FREQUENCY DOMAIN POWER

The following tables describe the total frequency domain power in data and Subframe boundary symbols. Table entries shown in brackets and italicized are for FFT size and scattered pilot pattern combinations that are not allowed (refer to Table 8.3).

Table I.2.1 Frequency Domain Total Power of Each Data and Subframe Boundary Symbol ($P_{data,m}$) when $C_{red_coeff}=0$

FFT Size	Pilot Pattern	L1D_scattered_pilot_boost				
		000	001	010	011	100
8K	SP3_2	7206.33	7206.33	7646.12	7967.68	8302.73
	SP3_4	7206.33	7427.12	7757.73	8018.64	8223.83
	SP4_2	7206.33	7335.49	7745.44	8069.14	8324.24
	SP4_4	7206.33	7477.44	7769.24	7971.39	8181.27
	SP6_2	7206.33	7463.93	7809.46	8080.54	8295.62
	SP6_4	7206.33	7497.87	7737.93	7927.21	8077.51
	SP8_2	7206.33	7492.88	7814.32	8024.02	8243.34
	SP8_4	7206.33	7490.93	7698.42	7862.96	7992.15
	SP12_2	7206.33	7522.86	7773.18	7969.29	8125.67
	SP12_4	7206.33	7475.54	7648.41	7783.36	7891.04
	SP16_2	7206.33	7512.03	7727.53	7897.38	8031.80
	SP16_4	7206.33	7466.13	7618.63	7738.99	7835.14
	SP24_2	7206.33	7491.23	7669.09	7809.50	7920.09
	SP24_4	7206.33	7440.66	7568.35	7669.30	7748.41
	SP32_2	7206.33	7477.75	7635.15	7744.12	7857.61
SP32_4	7206.33	7420.32	7532.04	7620.18	7690.50	
16K	SP3_2	14411.67	14411.67	15288.86	15932.70	16602.50
	SP3_4	14411.67	14851.86	15510.50	16028.89	16439.91
	SP4_2	14411.67	14668.83	15488.26	16134.29	16645.20
	SP4_4	14411.67	14952.26	15532.20	15935.04	16353.30
	SP6_2	14411.67	14926.41	15613.87	16156.56	16586.36
	SP6_4	14411.67	14989.75	15467.04	15842.95	16141.04
	SP8_2	14411.67	14983.09	15623.25	16044.16	16480.28
	SP8_4	14411.67	14974.58	15386.60	15711.94	15968.72
	SP12_2	14411.67	15041.63	15540.41	15932.96	16244.17
	SP12_4	14411.67	14943.26	15282.84	15550.82	15762.46
	SP16_2	14411.67	15019.66	15448.67	15787.59	16055.82
	SP16_4	14411.67	14920.95	15221.58	15458.22	15645.66
	SP24_2	14411.67	14978.51	15331.00	15609.88	15830.29
	SP24_4	14411.67	14867.25	15115.96	15311.51	15466.70
	SP32_2	14411.67	14950.04	15261.41	15477.36	15702.29
SP32_4	14411.67	14823.96	15040.47	15210.22	15345.66	
32K	SP3_2	28822.33	28822.33	30576.34	31863.75	33202.05
	SP3_4	(28822.33)	(29700.34)	(31015.05)	(32051.38)	(32872.06)
	SP4_2	N/A	N/A	N/A	N/A	N/A
	SP4_4	N/A	N/A	N/A	N/A	N/A
	SP6_2	28822.33	29850.37	31224.70	32309.62	33167.83
	SP6_4	(28822.33)	(29973.50)	(30925.26)	(31675.43)	(32269.09)

	SP8_2	28822.33	29963.53	31243.10	32082.43	32955.18
	SP8_4	(28822.33)	(29942.86)	(30763.97)	(31410.90)	(31921.87)
	SP12_2	28822.33	30080.16	31074.87	31858.28	32479.17
	SP12_4	(28822.33)	(29877.71)	(30551.70)	(31083.74)	(31504.30)
	SP16_2	28822.33	30033.92	30890.95	31567.00	32101.85
	SP16_4	(28822.33)	(29830.59)	(30426.47)	(30895.69)	(31267.72)
	SP24_2	28822.33	29951.08	30654.84	31209.63	31648.70
	SP24_4	(28822.33)	(29720.43)	(30211.16)	(30597.95)	(30904.27)
	SP32_2	28822.33	29893.61	30514.92	30944.83	31391.67
	SP32_4	(28822.33)	(29632.24)	(30056.33)	(30391.32)	(30655.98)

Table I.2.2 Frequency Domain Total Power of Each Data and Subframe Boundary Symbol ($P_{data,m}$) when $C_{red_coeff}=1$

FFT Size	Pilot Pattern	L1D_scattered_pilot_boost				
		000	001	010	011	100
8K	SP3_2	7110.33	7110.33	7543.95	7861.57	8191.33
	SP3_4	7110.33	7327.95	7654.33	7910.88	8114.70
	SP4_2	7110.33	7236.94	7641.52	7961.26	8213.26
	SP4_4	7110.33	7378.52	7666.26	7865.29	8072.61
	SP6_2	7110.33	7364.80	7704.79	7972.35	8184.48
	SP6_4	7110.33	7397.95	7634.83	7821.73	7969.81
	SP8_2	7110.33	7392.96	7709.54	7917.41	8132.67
	SP8_4	7110.33	7391.44	7595.59	7758.19	7885.30
	SP12_2	7110.33	7422.14	7668.57	7863.25	8017.32
	SP12_4	7110.33	7375.99	7546.56	7680.17	7786.06
	SP16_2	7110.33	7411.63	7624.20	7792.37	7925.08
	SP16_4	7110.33	7363.26	7511.56	7629.46	7721.49
	SP24_2	7110.33	7391.43	7567.41	7704.99	7814.54
	SP24_4	7110.33	7341.37	7467.34	7566.98	7645.90
	SP32_2	7110.33	7377.35	7531.46	7638.46	7749.85
	SP32_4	7110.33	7313.29	7419.22	7502.79	7569.50
16K	SP3_2	14219.67	14219.67	15085.51	15720.49	16379.71
	SP3_4	14219.67	14653.51	15302.71	15814.36	16219.64
	SP4_2	14219.67	14472.72	15281.42	15918.52	16422.23
	SP4_4	14219.67	14752.42	15325.23	15721.83	16133.97
	SP6_2	14219.67	14727.15	15405.54	15941.18	16364.07
	SP6_4	14219.67	14789.90	15259.85	15632.00	15925.64
	SP8_2	14219.67	14783.26	15414.68	15828.94	16259.96
	SP8_4	14219.67	14775.60	15181.94	15502.39	15756.02
	SP12_2	14219.67	14841.20	15332.19	15719.86	16026.47
	SP12_4	14219.67	14744.17	15079.15	15342.45	15551.49
	SP16_2	14219.67	14818.87	15242.01	15576.56	15840.38
	SP16_4	14219.67	14722.22	15018.45	15252.17	15436.38
	SP24_2	14219.67	14777.90	15126.65	15400.85	15618.19
	SP24_4	14219.67	14668.66	14913.92	15107.88	15260.67
	SP32_2	14219.67	14750.23	15058.02	15271.03	15492.78
	SP32_4	14219.67	14620.90	14830.83	14997.45	15128.66

32K	SP3_2	28438.33	28438.33	30167.65	31437.32	32756.47
	SP3_4	(28438.33)	(29304.65)	(30600.47)	(31622.33)	(32431.52)
	SP4_2	N/A	N/A	N/A	N/A	N/A
	SP4_4	N/A	N/A	N/A	N/A	N/A
	SP6_2	28438.33	29451.86	30808.03	31876.86	32723.26
	SP6_4	(28438.33)	(29573.80)	(30511.88)	(31251.52)	(31837.30)
	SP8_2	28438.33	29563.87	30824.95	31653.00	32513.53
	SP8_4	(28438.33)	(29543.90)	(30352.64)	(30990.81)	(31495.47)
	SP12_2	28438.33	29678.30	30659.43	31433.10	32044.77
	SP12_4	(28438.33)	(29478.52)	(30144.31)	(30668.01)	(31083.35)
	SP16_2	28438.33	29633.34	30478.63	31144.96	31671.98
	SP16_4	(28438.33)	(29433.12)	(30020.22)	(30483.58)	(30850.16)
	SP24_2	28438.33	29550.86	30245.14	30792.57	31225.49
	SP24_4	(28438.33)	(29324.25)	(29808.09)	(30189.68)	(30492.22)
	SP32_2	28438.33	29495.00	30107.15	30531.17	30971.65
SP32_4	(28438.33)	(29237.11)	(29655.05)	(29985.78)	(30246.99)	

Table I.2.3 Frequency Domain Total Power of Each Data and Subframe Boundary Symbol ($P_{data,m}$) when $C_{red_coeff}=2$

FFTSize	Pilot Pattern	L1D_scattered_pilot_boost				
		000	001	010	011	100
8K	SP3_2	7008.22	7008.22	7435.66	7748.36	8074.82
	SP3_4	7008.22	7223.66	7544.82	7798.01	7998.45
	SP4_2	7008.22	7133.27	7532.48	7846.26	8095.17
	SP4_4	7008.22	7272.48	7556.17	7752.08	7956.83
	SP6_2	7008.22	7258.56	7594.01	7858.05	8067.22
	SP6_4	7008.22	7290.91	7525.63	7709.14	7855.00
	SP8_2	7008.22	7286.93	7598.64	7803.69	8016.90
	SP8_4	7008.22	7284.84	7487.64	7646.30	7773.33
	SP12_2	7008.22	7316.32	7558.85	7751.09	7901.86
	SP12_4	7008.22	7270.34	7437.60	7569.88	7674.96
	SP16_2	7008.22	7305.13	7514.76	7680.24	7811.25
	SP16_4	7008.22	7260.28	7409.39	7526.82	7619.74
	SP24_2	7008.22	7285.51	7458.63	7595.36	7702.87
	SP24_4	7008.22	7235.96	7360.21	7458.55	7536.28
	SP32_2	7008.22	7272.84	7425.66	7531.68	7641.99
SP32_4	7008.22	7211.14	7317.29	7400.29	7467.39	
16K	SP3_2	14009.33	14009.33	14862.84	15488.94	16139.59
	SP3_4	14009.33	14437.84	15077.59	15582.50	15982.03
	SP4_2	14009.33	14259.28	15055.24	15683.41	16180.94
	SP4_4	14009.33	14534.24	15098.94	15490.30	15897.32
	SP6_2	14009.33	14509.56	15178.87	15706.47	16123.45
	SP6_4	14009.33	14570.72	15035.33	15401.71	15690.92
	SP8_2	14009.33	14565.10	15187.77	15596.39	16021.30
	SP8_4	14009.33	14557.28	14957.94	15273.51	15523.99
	SP12_2	14009.33	14622.43	15106.64	15488.44	15790.44
SP12_4	14009.33	14526.74	14856.11	15116.75	15323.18	

	SP16_2	14009.33	14599.75	15018.01	15347.20	15607.61
	SP16_4	14009.33	14504.15	14796.99	15026.78	15209.77
	SP24_2	14009.33	14559.96	14902.97	15174.49	15388.75
	SP24_4	14009.33	14452.74	14694.55	14884.91	15036.31
	SP32_2	14009.33	14533.10	14836.30	15046.37	15264.94
	SP32_4	14009.33	14410.50	14620.85	14786.35	14918.33
32K	SP3_2	28017.67	28017.67	29723.29	30974.22	32275.22
	SP3_4	(28017.67)	(28871.29)	(30149.22)	(31157.61)	(31954.31)
	SP4_2	N/A	N/A	N/A	N/A	N/A
	SP4_4	N/A	N/A	N/A	N/A	N/A
	SP6_2	28017.67	29016.68	30353.69	31407.43	32242.01
	SP6_4	(28017.67)	(29136.44)	(30061.84)	(30791.94)	(31368.85)
	SP8_2	28017.67	29127.54	30371.14	31186.90	32035.22
	SP8_4	(28017.67)	(29107.27)	(29905.65)	(30534.05)	(31032.40)
	SP12_2	28017.67	29240.78	30207.33	30970.25	31573.71
	SP12_4	(28017.67)	(29043.66)	(29699.25)	(30216.61)	(30625.74)
	SP16_2	28017.67	29196.10	30029.64	30686.24	31206.44
	SP16_4	(28017.67)	(28997.98)	(29577.29)	(30033.81)	(30395.92)
	SP24_2	28017.67	29114.97	29798.77	30338.84	30765.60
	SP24_4	(28017.67)	(28891.40)	(29368.35)	(29744.74)	(30042.50)
	SP32_2	28017.67	29059.72	29662.71	30080.84	30515.97
	SP32_4	(28017.67)	(28805.32)	(29218.10)	(29543.57)	(29801.34)

Table I.2.4 Frequency Domain Total Power of Each Data and Subframe Boundary Symbol ($P_{data,m}$) when $C_{red_coeff}=3$

FFT Size	Pilot Pattern	L1D_scattered_pilot_boost				
		000	001	010	011	100
8K	SP3_2	6906.11	6906.11	7327.38	7636.14	7957.32
	SP3_4	6906.11	7118.38	7434.32	7684.13	7882.20
	SP4_2	6906.11	7029.60	7422.45	7732.26	7978.08
	SP4_4	6906.11	7166.45	7446.08	7639.87	7841.06
	SP6_2	6906.11	7153.32	7484.23	7743.75	7949.97
	SP6_4	6906.11	7184.88	7415.42	7597.55	7741.20
	SP8_2	6906.11	7180.91	7488.74	7689.97	7900.13
	SP8_4	6906.11	7179.24	7378.70	7535.42	7660.37
	SP12_2	6906.11	7209.49	7449.13	7637.93	7787.40
	SP12_4	6906.11	7164.68	7329.64	7460.59	7562.86
	SP16_2	6906.11	7198.63	7405.31	7569.12	7698.43
	SP16_4	6906.11	7151.31	7296.21	7410.19	7500.99
	SP24_2	6906.11	7179.60	7349.84	7484.74	7591.21
	SP24_4	6906.11	7130.55	7254.08	7350.12	7426.65
	SP32_2	6906.11	7165.32	7315.85	7419.91	7528.12
	SP32_4	6906.11	7109.00	7215.35	7298.80	7365.28
16K	SP3_2	13811.22	13811.22	14652.38	15269.62	15910.69
	SP3_4	13811.22	14233.38	14863.69	15361.87	15755.65
	SP4_2	13811.22	14057.06	14842.28	15461.53	15951.87
	SP4_4	13811.22	14329.28	14885.87	15270.98	15671.88

	SP6_2	13811.22	14304.20	14963.42	15483.98	15895.05
	SP6_4	13811.22	14364.76	14823.03	15183.64	15469.41
	SP8_2	13811.22	14359.16	14973.09	15375.06	15793.87
	SP8_4	13811.22	14351.19	14746.17	15057.86	15304.17
	SP12_2	13811.22	14414.89	14892.31	15269.23	15567.63
	SP12_4	13811.22	14320.54	14646.31	14903.28	15106.09
	SP16_2	13811.22	14393.85	14805.24	15130.07	15387.07
	SP16_4	13811.22	14299.30	14587.75	14814.62	14994.37
	SP24_2	13811.22	14354.24	14692.51	14959.35	15170.53
	SP24_4	13811.22	14248.04	14486.41	14675.16	14824.17
	SP32_2	13811.22	14327.18	14626.80	14832.92	15048.32
	SP32_4	13811.22	14201.32	14406.10	14567.47	14695.23
32K	SP3_2	27621.44	27621.44	29302.38	30535.58	31818.42
	SP3_4	(27621.44)	(28463.38)	(29723.42)	(30716.34)	(31502.55)
	SP4_2	N/A	N/A	N/A	N/A	N/A
	SP4_4	N/A	N/A	N/A	N/A	N/A
	SP6_2	27621.44	28605.95	29923.80	30963.45	31785.21
	SP6_4	(27621.44)	(28724.52)	(29636.24)	(30355.81)	(30924.84)
	SP8_2	27621.44	28715.66	29940.78	30745.24	31582.35
	SP8_4	(27621.44)	(28696.09)	(29482.10)	(30101.74)	(30592.78)
	SP12_2	27621.44	28826.70	29779.67	30531.84	31126.09
	SP12_4	(27621.44)	(28633.25)	(29279.63)	(29788.66)	(30192.56)
	SP16_2	27621.44	28783.31	29604.09	30251.97	30764.35
	SP16_4	(27621.44)	(28588.29)	(29158.82)	(29609.48)	(29966.13)
	SP24_2	27621.44	28702.53	29377.85	29909.56	30330.17
	SP24_4	(27621.44)	(28483.00)	(28953.06)	(29324.25)	(29618.22)
	SP32_2	27621.44	28647.89	29243.71	29655.96	30083.72
	SP32_4	(27621.44)	(28397.97)	(28804.59)	(29125.81)	(29380.12)

Table I.2.5 Frequency Domain Total Power of Each Data and Subframe Boundary Symbol ($P_{data,m}$) when $C_{red_coeff}=4$

FFT Size	Pilot Pattern	L1D_scattered_pilot_boost				
		000	001	010	011	100
8K	SP3_2	6804.00	6804.00	7219.10	7523.92	7839.81
	SP3_4	6804.00	7013.10	7324.81	7571.26	7765.96
	SP4_2	6804.00	6925.93	7313.42	7618.26	7859.99
	SP4_4	6804.00	7060.42	7335.99	7527.66	7725.28
	SP6_2	6804.00	7048.08	7373.45	7630.44	7832.71
	SP6_4	6804.00	7078.84	7306.22	7485.96	7627.39
	SP8_2	6804.00	7074.88	7377.85	7577.25	7783.36
	SP8_4	6804.00	7072.64	7269.76	7424.54	7547.41
	SP12_2	6804.00	7102.67	7339.41	7525.78	7672.94
	SP12_4	6804.00	7059.02	7221.68	7350.29	7451.76
	SP16_2	6804.00	7093.12	7296.87	7457.00	7584.60
	SP16_4	6804.00	7049.33	7194.04	7308.55	7399.24
	SP24_2	6804.00	7073.68	7242.05	7374.11	7479.54
	SP24_4	6804.00	7026.15	7146.95	7242.69	7318.03

	SP32_2	6804.00	7060.81	7210.05	7313.13	7420.25
	SP32_4	6804.00	7006.86	7112.42	7196.30	7263.17
16K	SP3_2	13607.00	13607.00	14435.81	15044.18	15676.67
	SP3_4	13607.00	14022.81	14644.67	15135.12	15523.16
	SP4_2	13607.00	13849.72	14623.21	15233.53	15716.68
	SP4_4	13607.00	14117.21	14665.68	15045.56	15441.33
	SP6_2	13607.00	14092.72	14742.86	15255.38	15661.54
	SP6_4	13607.00	14152.69	14603.62	14959.46	15240.79
	SP8_2	13607.00	14147.11	14751.29	15148.62	15561.33
	SP8_4	13607.00	14138.99	14528.28	14836.09	15078.25
	SP12_2	13607.00	14202.24	14672.87	15043.92	15337.71
	SP12_4	13607.00	14109.22	14430.39	14683.69	14883.90
	SP16_2	13607.00	14180.85	14586.36	14906.82	15159.41
	SP16_4	13607.00	14088.34	14372.40	14596.34	14773.87
	SP24_2	13607.00	14142.41	14475.94	14739.09	14947.20
	SP24_4	13607.00	14038.22	14273.15	14458.30	14605.93
	SP32_2	13607.00	14116.15	14410.20	14614.37	14826.59
	SP32_4	13607.00	13997.04	14202.24	14363.48	14491.01
32K	SP3_2	27213.00	27213.00	28869.25	30085.70	31349.40
	SP3_4	(27213.00)	(28042.25)	(29284.40)	(30262.84)	(31037.56)
	SP4_2	N/A	N/A	N/A	N/A	N/A
	SP4_4	N/A	N/A	N/A	N/A	N/A
	SP6_2	27213.00	28184.00	29482.69	30506.24	31317.19
	SP6_4	(27213.00)	(28300.38)	(29199.42)	(29907.46)	(30468.61)
	SP8_2	27213.00	28291.55	29499.19	30292.36	31116.26
	SP8_4	(27213.00)	(28271.68)	(29047.33)	(29658.20)	(30141.93)
	SP12_2	27213.00	28400.40	29340.78	30081.21	30667.25
	SP12_4	(27213.00)	(28209.62)	(28846.79)	(29349.48)	(29747.17)
	SP16_2	27213.00	28357.29	29167.33	29805.48	30311.03
	SP16_4	(27213.00)	(28165.37)	(28728.11)	(29171.93)	(29523.12)
	SP24_2	27213.00	28278.87	28943.71	29468.06	29882.51
	SP24_4	(27213.00)	(28061.37)	(28525.54)	(28891.53)	(29180.72)
	SP32_2	27213.00	28224.84	28811.49	29217.85	29640.26
	SP32_4	(27213.00)	(27978.40)	(28379.87)	(28695.83)	(28946.69)

Annex J: MISO

J.1 MISO FREQUENCY DOMAIN COEFFICIENTS

Table J.1.1 Time Domain Impulse Response Vectors for $N_{MISO}=64$

n	$N_{TX}=2$		$N_{TX}=3$			$N_{TX}=4$			
	h_1	h_2	h_1	h_2	h_3	h_1	h_2	h_3	h_4
0	-0.0082-j0.0031	0.0570+j0.0402	-0.0202-j0.0157	-0.0351-j0.0356	0.0436+j0.0054	0.0240-j0.0409	-0.0263-j0.0479	-0.0233-j0.0047	0.0050+j0.0373
1	0.0041-j0.0092	-0.0200+j0.0170	-0.0397-j0.0295	0.0087-j0.0039	0.0171-j0.0086	0.0012-j0.0723	-0.0301-j0.0107	0.0235+j0.0189	0.0239+j0.0232
2	-0.0192-j0.0795	-0.0538+j0.0115	0.0051-j0.0108	-0.0400-j0.0028	-0.0079-j0.0112	-0.0192-j0.0187	0.0333-j0.0063	0.0180+j0.0330	0.0302-j0.0206
3	-0.0321+j0.0025	-0.0197-j0.1022	0.0365-j0.0003	0.0228+j0.0060	0.0037-j0.0093	0.0487+j0.0256	0.0204+j0.0289	-0.0042-j0.0688	-0.0148-j0.0121
4	-0.0234+j0.0615	-0.0244-j0.0409	-0.0195-j0.0111	0.0347-j0.0134	0.0549-j0.0019	0.0508-j0.0429	-0.0105+j0.0583	0.0140-j0.0162	-0.0007-j0.0009
5	-0.0257-j0.0544	0.0925+j0.0289	-0.1033+j0.0267	-0.0351-j0.0292	-0.0391+j0.0219	-0.0400-j0.0598	-0.0649-j0.1346	-0.0297+j0.0627	-0.0177-j0.0167
6	-0.0599-j0.0362	-0.0082+j0.0075	-0.0409+j0.0354	-0.0091-j0.0239	-0.0306-j0.0150	-0.0299+j0.0292	-0.0243-j0.0626	-0.0144-j0.0526	-0.0166+j0.0221
7	-0.0472+j0.0203	0.0795+j0.0501	-0.0243-j0.0359	-0.1048-j0.0459	0.0398+j0.0042	0.0171-j0.0085	0.0599-j0.0728	-0.0466+j0.0299	-0.0181-j0.0276
8	0.0925-j0.0460	0.0124-j0.0371	-0.0291-j0.0020	0.0814-j0.0157	-0.0360-j0.0737	-0.0452-j0.0488	0.0119+j0.0809	0.0060+j0.0085	0.0012+j0.0362
9	0.0217-j0.0165	0.0266+j0.0384	0.0027+j0.1260	0.0278+j0.0517	0.0432-j0.0191	-0.1012+j0.0784	0.0566+j0.0771	0.0173-j0.1123	0.0114+j0.0245
10	-0.1060+j0.0672	-0.0644-j0.0655	0.0495+j0.0905	-0.0310+j0.0042	-0.0297-j0.0303	0.0182+j0.0737	-0.0317-j0.1009	-0.0095-j0.0079	-0.0201-j0.0881
11	0.0356+j0.0135	-0.0565+j0.0211	0.0206-j0.0591	0.0082-j0.0551	-0.0421-j0.0442	0.0460-j0.0497	0.0592-j0.0811	0.0554+j0.0071	0.0430+j0.0391
12	-0.0765-j0.0388	0.0711+j0.0100	-0.0658+j0.0847	-0.1074-j0.1147	-0.0423+j0.0888	-0.1181+j0.0534	-0.1045-j0.1392	0.0341-j0.0753	0.0106-j0.0458
13	-0.1158+j0.1144	-0.0186+j0.0228	0.0361+j0.0878	0.0709+j0.0104	0.0681-j0.0220	-0.0447+j0.1291	-0.1084-j0.0149	-0.0615+j0.0015	-0.0337-j0.0743
14	0.0197+j0.1516	0.1920-j0.0084	0.1156-j0.0646	0.0134-j0.0183	-0.1486-j0.0084	0.1023-j0.0167	0.0758-j0.0852	-0.1283+j0.0457	-0.0617+j0.0517
15	-0.0359+j0.0376	0.0029-j0.0932	-0.1034-j0.0663	0.0391+j0.0550	0.1086-j0.0260	-0.0501-j0.1357	0.0799-j0.0393	0.0546-j0.1677	0.0011+j0.0323
16	-0.0932+j0.0818	0.1438+j0.0361	-0.1042-j0.0011	0.2130+j0.1695	-0.0102+j0.0763	-0.0843-j0.1035	0.2092+j0.1991	-0.0932+j0.2335	-0.0128+j0.0034
17	-0.0454+j0.1093	-0.0405+j0.0996	0.0373+j0.0515	-0.2063+j0.0635	-0.0520-j0.0592	-0.0382-j0.0540	-0.1139-j0.0389	-0.1123+j0.0290	-0.0525-j0.0809
18	0.0692-j0.0114	-0.1229-j0.1549	-0.1169-j0.0665	-0.0821+j0.0257	0.0022-j0.0342	-0.0657-j0.1025	-0.0529-j0.0304	0.1421+j0.0877	-0.0457+j0.1235
19	-0.0801-j0.0271	-0.0177-j0.1009	-0.1598-j0.0456	-0.1664-j0.1884	-0.0331+j0.0601	-0.0362-j0.0847	-0.0902-j0.1026	0.0467-j0.1229	0.1259+j0.0362
20	-0.1156-j0.0505	0.0610-j0.0604	0.0191-j0.0271	0.0600+j0.0789	-0.0826+j0.0136	0.0219-j0.0437	0.0859+j0.0258	0.0059+j0.0987	-0.0608-j0.0147
21	0.2071-j0.0987	0.3258-j0.0067	0.0155-j0.0469	0.1633+j0.1717	0.1155+j0.2692	0.0146-j0.0333	0.1311+j0.1771	0.0374-j0.0089	-0.0241-j0.2151
22	0.0217+j0.1298	0.0486+j0.1430	-0.0536+j0.1606	-0.1040+j0.1295	0.0776-j0.2126	-0.1189-j0.1498	0.0212+j0.0289	-0.0469-j0.1116	-0.2348+j0.0577
23	0.0305-j0.1189	0.0057+j0.0169	-0.0881+j0.1063	0.1314-j0.0204	0.0330-j0.0684	-0.1678+j0.0733	0.1347-j0.0075	-0.0315+j0.0372	0.0898+j0.0509
24	0.1325+j0.1816	-0.0468+j0.0400	0.0136+j0.1160	-0.1336+j0.0564	0.0150-j0.0269	-0.0205+j0.0349	-0.0492+j0.1194	-0.0329+j0.0249	0.0000-j0.0149
25	0.0220+j0.1673	-0.0580-j0.1502	-0.0165+j0.0980	-0.0383+j0.1788	-0.1286+j0.0254	-0.0220+j0.1345	-0.0598-j0.0809	-0.1220+j0.1634	-0.1193+j0.0479
26	0.2034-j0.1647	0.0839+j0.2601	0.3054-j0.0506	-0.1792+j0.2524	-0.0529-j0.3026	0.2133-j0.0547	-0.0676+j0.2751	0.0901-j0.0367	-0.1443+j0.0473
27	0.1139-j0.0092	-0.0909-j0.0273	0.1229-j0.1970	-0.0639+j0.0308	0.0871+j0.1886	0.1213+j0.1973	-0.0033+j0.0489	0.1698+j0.1548	0.0574-j0.1223
28	-0.0485+j0.2120	0.0683+j0.0433	-0.1988+j0.2747	-0.0327+j0.0499	-0.0810+j0.0120	-0.1696+j0.3086	-0.1294+j0.1162	-0.0707-j0.0577	0.0818+j0.0683
29	0.0006-j0.0205	-0.1055+j0.0668	0.0473+j0.0365	-0.0426-j0.0327	0.0934-j0.0558	-0.0591-j0.0141	-0.1280+j0.0001	-0.1228+j0.0759	0.1011-j0.1585
30	-0.0667+j0.0071	-0.2471-j0.0933	-0.0451+j0.1114	-0.1421-j0.0480	0.1699-j0.0469	0.0167+j0.0481	-0.0536-j0.1314	0.2568+j0.0969	-0.0604-j0.0786
31	-0.2077-j0.2282	0.0682+j0.2381	-0.1865-j0.1219	0.0324+j0.1438	0.1644-j0.1603	-0.1727-j0.1232	0.0334+j0.1431	-0.0160+j0.0148	0.0911-j0.2836
32	-0.1265+j0.0798	0.0195-j0.1981	-0.0820-j0.0034	0.0780-j0.0666	-0.1104+j0.0125	-0.0513+j0.0157	0.0520+j0.0127	0.1090-j0.0340	-0.1751-j0.0192
33	0.0276-j0.1123	-0.0465+j0.0036	-0.1170+j0.0836	-0.1150-j0.0442	0.0423-j0.0163	-0.1042+j0.1508	-0.0859-j0.0728	-0.0061-j0.2155	0.0056-j0.1524
34	-0.0043+j0.1419	-0.0331+j0.0257	0.0354+j0.0839	0.1399+j0.0277	0.0720+j0.0480	0.0128+j0.0261	-0.0147+j0.0550	0.0134+j0.0477	0.0249-j0.0000
35	0.0147-j0.0002	0.1589+j0.0603	0.2146+j0.0002	0.0795+j0.0892	0.0027-j0.0066	0.1502+j0.0075	0.1340+j0.2318	0.0510-j0.0546	-0.1729+j0.0337
36	0.0066-j0.0353	0.0641+j0.1233	0.1105-j0.1351	-0.0085-j0.0374	-0.0916+j0.0016	0.1558-j0.0742	-0.0182-j0.0708	-0.0063+j0.0183	-0.0397-j0.0840
37	-0.1775+j0.1532	0.0678+j0.1191	-0.0920+j0.0875	0.0953+j0.0980	-0.0783-j0.2550	-0.1810+j0.0746	0.0938+j0.1883	-0.0733+j0.1909	-0.0398-j0.3157
38	-0.0491+j0.0762	0.0271-j0.2271	-0.0300-j0.1244	0.1254-j0.1780	-0.1807+j0.1094	0.0573-j0.0604	0.0505-j0.0878	-0.0475+j0.1187	0.2074-j0.0389
39	-0.1185-j0.1370	0.0877-j0.1282	-0.1987-j0.0400	-0.1259+j0.0849	0.0347+j0.1010	-0.1213-j0.1572	-0.0316+j0.0609	-0.0415+j0.1335	-0.0265+j0.2476
40	0.1381+j0.1197	-0.1054+j0.0719	0.0853+j0.0506	-0.1303+j0.0004	-0.0434+j0.1560	-0.0473+j0.2651	-0.1373+j0.0291	0.0628+j0.1182	0.2462-j0.1978
41	0.0402-j0.1385	0.1926-j0.0134	-0.1360-j0.1131	0.1888+j0.0584	0.0427+j0.1170	-0.1701-j0.1300	0.2823-j0.0664	-0.0947+j0.0036	0.1360-j0.1081
42	-0.0414-j0.0215	0.0272-j0.0083	0.0036+j0.0701	-0.1031-j0.0692	-0.0744-j0.0089	-0.0475+j0.0891	0.0269-j0.0262	0.0648-j0.2780	0.0269+j0.0323
43	0.0425-j0.2408	-0.0126+j0.0324	0.1415-j0.1823	-0.0871-j0.0654	-0.1619-j0.0234	0.0860-j0.1701	-0.0174-j0.0057	-0.0856+j0.0200	0.0348-j0.1474
44	0.0778+j0.1461	0.1290-j0.0779	-0.0022+j0.1309	-0.0039-j0.0491	0.1864+j0.1523	0.0287-j0.0118	0.0651-j0.0408	0.0757+j0.0776	-0.0682-j0.0088
45	-0.2283+j0.0223	0.1207-j0.0885	-0.1185-j0.1542	-0.0021+j0.0591	0.1173-j0.0573	-0.2152-j0.1151	0.1702+j0.0152	0.0913-j0.1074	0.0387-j0.0759
46	0.0196+j0.0578	-0.0827-j0.1182	0.0331-j0.0297	-0.1821-j0.1699	-0.0136+j0.0547	0.0911-j0.0229	-0.1067-j0.1807	-0.0469-j0.0884	-0.0351+j0.1037
47	-0.0309-j0.1078	-0.0020-j0.0275	-0.0268-j0.0252	-0.0221+j0.0450	-0.0126-j0.0084	0.0227+j0.0191	-0.0661-j0.0909	0.0390-j0.2093	-0.1447-j0.0196
48	0.0340-j0.0156	0.0280-j0.0564	0.1085-j0.1090	-0.1060+j0.1698	-0.0269+j0.0097	0.0164+j0.0224	-0.1148-j0.1257	0.0610-j0.1203	-0.1227-j0.0640
49	0.0431-j0.0505	-0.1056-j0.0500	-0.1165-j0.0823	0.0634+j0.0286	0.1539+j0.0925	-0.0265-j0.0111	-0.0864-j0.0229	0.0021+j0.1465	0.0076-j0.1253
50	-0.0656-j0.1008	-0.1652-j0.0210	0.0427-j0.0327	0.0531+j0.0341	-0.0388+j0.0407	-0.0469-j0.0784	-0.0557-j0.0173	-0.0649+j0.0788	-0.0569-j0.0363
51	0.0719+j0.1280	-0.0103+j0.1312	-0.0317-j0.0209	0.0299+j0.0984	-0.0974+j0.1576	-0.0250+j0.1309	-0.0489+j0.1720	-0.2232+j0.0983	-0.0810-j0.0190
52	-0.0367-j0.0387	-0.0025-j0.0292	-0.0064+j0.0446	0.0960-j0.0295	-0.0565-j0.0025	-0.0179-j0.0898	0.0189-j0.0422	0.0063-j0.0601	-0.0890-j0.1005
53	0.0549+j0.0875	0.0094-j0.0186	-0.0394+j0.0371	0.1152-j0.0318	-0.1553-j0.1074	0.0119+j0.0266	0.1237-j0.0095	-0.0743-j0.1217	-0.0343+j0.0293

n	$N_{TX}=2$		$N_{TX}=3$			$N_{TX}=4$			
	h_1	h_2	h_1	h_2	h_3	h_1	h_2	h_3	h_4
54	-0.0199-j0.0339	0.0529-j0.0211	0.0534-j0.0665	-0.0462-j0.0994	0.0834+j0.0164	0.0177-j0.0294	0.0096+j0.0209	-0.0850+j0.0442	-0.0496+j0.0054
55	0.0247-j0.0080	0.0285+j0.0582	0.0524+j0.0609	-0.0231-j0.0581	0.1502-j0.0071	0.0367-j0.0083	-0.0192-j0.0478	0.0500-j0.0122	-0.0468-j0.0352
56	-0.0482-j0.0159	0.0386-j0.0935	-0.0057-j0.0144	-0.0681+j0.0278	0.1019+j0.1022	-0.0132-j0.0501	0.0511-j0.0060	0.0083+j0.0355	0.0064-j0.0181
57	0.0474-j0.0310	0.0283-j0.0598	0.0164+j0.0052	-0.0226+j0.0018	0.0256+j0.0919	0.0458-j0.0252	0.0123+j0.0400	0.0793+j0.0643	-0.0094+j0.0168
58	-0.0262+j0.0055	-0.0550+j0.0053	-0.0345-j0.0144	-0.0124-j0.0168	-0.0529+j0.0828	-0.0354+j0.0197	-0.0456-j0.0497	0.0799+j0.0421	0.0138+j0.0256
59	-0.0185-j0.0061	0.0113-j0.0073	0.0396+j0.0416	-0.0306+j0.0504	-0.0240+j0.0590	0.0074+j0.0287	-0.0084+j0.0188	-0.0598+j0.0669	-0.0331+j0.1121
60	0.0547+j0.0236	-0.0100-j0.0336	-0.0661+j0.0017	-0.0153+j0.0185	-0.0182-j0.0669	0.0374+j0.0192	-0.0052+j0.0608	-0.0535-j0.0376	0.0025+j0.0350
61	-0.0084+j0.0174	-0.0605+j0.0318	0.0363+j0.0182	0.0665-j0.0023	-0.0049-j0.0340	0.0393-j0.0109	0.0208-j0.0086	-0.0449-j0.0622	0.0306+j0.0165
62	0.0030+j0.0153	-0.0212+j0.0315	0.0092-j0.0382	-0.0147-j0.0080	0.0299-j0.0039	-0.0036-j0.0001	0.0235-j0.0157	0.0532-j0.0191	0.0001+j0.0608
63	-0.0339-j0.0449	0.0100+j0.0136	0.0467+j0.0337	-0.0025-j0.0243	-0.0036-j0.0072	-0.0159-j0.0341	-0.0051-j0.0114	0.0824-j0.0414	-0.0023-j0.0119

Table J.1.2 Time Domain Impulse Response Vectors for $N_{MISO}=256$

n	$N_{TX}=2$		$N_{TX}=3$			$N_{TX}=4$			
	h_1	h_2	h_1	h_2	h_3	h_1	h_2	h_3	h_4
0	0.0045+j0.0013	-0.0073-j0.0104	0.0093+j0.0035	-0.0061-j0.0171	0.0090-j0.0232	0.0004+j0.0031	-0.0095-j0.0115	0.0211-j0.0237	-0.0128+j0.0022
1	-0.0108-j0.0006	0.0166-j0.0106	-0.0144-j0.0004	0.0228-j0.0183	-0.0063+j0.0283	-0.0165+j0.0023	0.0214-j0.0144	-0.0070+j0.0292	-0.0144+j0.0046
2	0.0279-j0.0059	0.0135+j0.0047	0.0299-j0.0033	0.0092-j0.0013	0.0035-j0.0104	0.0245-j0.0058	0.0091-j0.0007	0.0116-j0.0123	0.0102-j0.0130
3	0.0071+j0.0211	0.0036-j0.0299	0.0160+j0.0102	-0.0034-j0.0253	-0.0032+j0.0081	0.0167+j0.0009	-0.0083-j0.0244	-0.0091+j0.0070	0.0048-j0.0072
4	0.0110+j0.0023	-0.0134-j0.0009	0.0199+j0.0220	-0.0078+j0.0053	0.0186+j0.0177	0.0120+j0.0131	-0.0058+j0.0098	0.0220+j0.0165	0.0065-j0.0035
5	0.0030+j0.0203	-0.0218+j0.0179	-0.0067-j0.0215	-0.0151-j0.0060	0.0051-j0.0115	-0.0032+j0.0200	-0.0153+j0.0044	-0.0054-j0.0128	0.0098+j0.0061
6	0.0056-j0.0249	0.0187-j0.0170	0.0100-j0.0293	0.0271-j0.0174	0.0117+j0.0091	-0.0019-j0.0154	0.0193-j0.0141	0.0086+j0.0114	-0.0074+j0.0324
7	0.0092-j0.0039	0.0149-j0.0003	0.0134-j0.0010	0.0351+j0.0050	-0.0202-j0.0270	0.0200+j0.0029	0.0248+j0.0116	-0.0135-j0.0310	-0.0179-j0.0038
8	-0.0148-j0.0216	-0.0432+j0.0004	-0.0009-j0.0266	-0.0410+j0.0009	-0.0039+j0.0029	0.0042-j0.0238	-0.0403+j0.0087	-0.0046+j0.0073	-0.0142-j0.0178
9	0.0227+j0.0006	0.0045-j0.0103	0.0204-j0.0031	0.0096-j0.0047	0.0039-j0.0035	0.0157-j0.0064	0.0065-j0.0029	-0.0007-j0.0182	0.0133+j0.0090
10	-0.0354+j0.0028	-0.0252+j0.0062	-0.0355-j0.0003	-0.0122+j0.0075	-0.0183-j0.0057	-0.0295-j0.0042	-0.0225+j0.0106	-0.0266+j0.0079	0.0004-j0.0078
11	0.0068-j0.0218	0.0069-j0.0264	0.0197-j0.0093	0.0137-j0.0335	0.0455+j0.0020	0.0148-j0.0095	0.0148-j0.0256	0.0448+j0.0005	-0.0136-j0.0148
12	-0.0016+j0.0243	0.0301-j0.0145	0.0086+j0.0150	0.0226+j0.0110	-0.0392+j0.0015	0.0146+j0.0196	0.0306+j0.0029	-0.0357+j0.0075	0.0230-j0.0072
13	0.0215+j0.0011	-0.0007-j0.0090	0.0244-j0.0167	-0.0041-j0.0116	0.0321+j0.0336	0.0070-j0.0012	-0.0124-j0.0195	0.0398+j0.0369	-0.0029+j0.0005
14	0.0128+j0.0190	-0.0085-j0.0159	0.0133+j0.0135	-0.0114-j0.0232	0.0056+j0.0009	0.0049+j0.0226	-0.0092-j0.0208	0.0146-j0.0004	-0.0186-j0.0010
15	-0.0170-j0.0274	0.0549-j0.0085	0.0090-j0.0159	0.0509-j0.0034	-0.0306-j0.0043	0.0121-j0.0134	0.0573-j0.0050	-0.0320-j0.0088	-0.0057-j0.0272
16	0.0130+j0.0133	-0.0089-j0.0140	0.0168+j0.0208	0.0064-j0.0086	-0.0091-j0.0140	0.0223+j0.0167	0.0105-j0.0097	-0.0078-j0.0245	0.0203+j0.0036
17	-0.0226-j0.0192	0.0317-j0.0104	-0.0210-j0.0375	0.0288+j0.0066	-0.0241-j0.0136	-0.0111-j0.0337	0.0427+j0.0125	-0.0258+j0.0186	-0.0039-j0.0021
18	0.0310+j0.0146	0.0254+j0.0035	0.0229+j0.0021	0.0295+j0.0044	0.0288-j0.0617	0.0202-j0.0008	0.0247+j0.0039	0.0122-j0.0585	-0.0068+j0.0133
19	-0.0464+j0.0068	0.0057-j0.0023	-0.0420-j0.0028	0.0101-j0.0048	-0.0103+j0.0207	-0.0357+j0.0115	0.0036-j0.0034	-0.0119+j0.0227	0.0095-j0.0003
20	-0.0146-j0.0082	-0.0407+j0.0112	-0.0246+j0.0031	-0.0181+j0.0293	-0.0092-j0.0465	-0.0241+j0.0010	-0.0096+j0.0298	-0.0018-j0.0460	0.0188+j0.0256
21	-0.0006-j0.0058	0.0213-j0.0073	-0.0080-j0.0268	0.0283+j0.0201	0.0419+j0.0171	-0.0029-j0.0266	0.0317-j0.0184	0.0422-j0.0124	0.0138+j0.0215
22	0.0176-j0.0200	-0.0034+j0.0153	0.0371-j0.0356	0.0050+j0.0085	-0.0087-j0.0099	0.0274-j0.0347	0.0046+j0.0082	-0.0073-j0.0089	0.0018-j0.0024
23	0.0024+j0.0210	-0.0092-j0.0131	-0.0136-j0.0227	-0.0110-j0.0237	-0.0135-j0.0066	-0.0138-j0.0159	-0.0107-j0.0248	-0.0126-j0.0086	0.0203-j0.0007
24	-0.0225-j0.0259	0.0175-j0.0359	-0.0170-j0.0142	0.0366-j0.0282	0.0237+j0.0160	-0.0062-j0.0129	0.0334-j0.0321	0.0212-j0.0121	0.0360+j0.0254
25	-0.0081+j0.0521	0.0068-j0.0005	-0.0045+j0.0480	0.0072-j0.0156	-0.0426-j0.0066	-0.0062+j0.0346	0.0025+j0.0164	-0.0488-j0.0056	0.0037+j0.0131
26	-0.0164-j0.0158	0.0384-j0.0283	-0.0071-j0.0366	0.0320-j0.0332	0.0553-j0.0275	-0.0111-j0.0339	0.0374-j0.0319	0.0524-j0.0306	-0.0168-j0.0072
27	0.0399+j0.0106	0.0472-j0.0463	0.0288+j0.0179	0.0196-j0.0537	-0.0581+j0.0043	0.0195+j0.0310	0.0079-j0.0462	-0.0643+j0.0008	0.0255-j0.0002
28	-0.0185-j0.0221	0.0095-j0.0010	-0.0264-j0.0225	0.0318-j0.0046	0.0345-j0.0152	-0.0181-j0.0247	0.0337-j0.0101	0.0315-j0.0157	-0.0028-j0.0044
29	-0.0036-j0.0069	0.0449+j0.0161	0.0237-j0.0035	0.0559+j0.0270	-0.0210+j0.0039	0.0279-j0.0055	0.0577+j0.0256	-0.0223-j0.0032	-0.0355-j0.0171
30	0.0136-j0.0067	0.1051+j0.0253	0.0027-j0.0245	0.1062+j0.0272	-0.0105+j0.0159	0.0034-j0.0307	0.0958+j0.0245	-0.0123+j0.0214	-0.0141-j0.0232
31	0.0455-j0.0925	-0.0274+j0.0124	0.0570-j0.0796	-0.0388+j0.0178	0.0426+j0.0036	0.0588-j0.0812	-0.0413+j0.0127	0.0434+j0.0052	0.0025+j0.0042
32	0.0238+j0.0229	0.0293-j0.0257	-0.0026-j0.0246	0.0426-j0.0314	-0.0281+j0.0163	-0.0080+j0.0307	0.0530-j0.0345	-0.0231+j0.0217	-0.0118+j0.0155
33	-0.0113-j0.0309	-0.0134+j0.0156	0.0161-j0.0355	0.0089+j0.0377	0.0215-j0.0323	0.0104-j0.0341	-0.0017+j0.0302	0.0270-j0.0297	-0.0467-j0.0381
34	0.0486+j0.0256	0.0053+j0.0121	0.0537+j0.0316	0.0225+j0.0198	-0.0262+j0.0474	0.0543+j0.0322	0.0160+j0.0250	-0.0221+j0.0443	0.0085+j0.0129
35	-0.0266-j0.0014	0.0281-j0.0126	-0.0233-j0.0263	0.0222+j0.0202	0.0091+j0.0464	-0.0239-j0.0256	0.0101+j0.0312	0.0056+j0.0435	0.0118+j0.0267
36	0.0609-j0.0451	-0.0056+j0.0137	0.0668-j0.0349	0.0023+j0.0194	-0.0014-j0.0165	0.0737-j0.0372	-0.0038+j0.0149	-0.0002-j0.0108	-0.0522-j0.0478
37	-0.0094+j0.0148	-0.0692-j0.0589	-0.0130+j0.0105	-0.0601-j0.0445	-0.0202-j0.0010	-0.0150+j0.0085	-0.0561-j0.0541	-0.0257-j0.0058	-0.0066+j0.0363
38	-0.0168-j0.0255	0.1044-j0.0731	0.0028-j0.0168	0.0963-j0.0611	-0.0209-j0.0709	0.0014-j0.0074	0.0918-j0.0501	-0.0278-j0.0707	-0.0050-j0.0138
39	-0.0434+j0.0156	-0.0079-j0.0032	-0.0471-j0.0035	-0.0236+j0.0244	-0.0302+j0.0489	-0.0607-j0.0073	-0.0360+j0.0266	-0.0369+j0.0560	-0.0168+j0.0023
40	-0.0064-j0.0473	0.0135+j0.0164	-0.0180-j0.0594	-0.0036-j0.0153	0.0063-j0.0627	-0.0182-j0.0675	0.0022-j0.0090	0.0098-j0.0661	0.0033-j0.0110
41	0.0249+j0.0037	0.0163+j0.0300	0.0146-j0.0098	0.0120+j0.0385	-0.0171+j0.0505	0.0246+j0.0110	0.0212+j0.0352	-0.0130+j0.0416	0.0333-j0.0079
42	-0.0279+j0.0322	0.0539-j0.0584	-0.0399-j0.0276	0.0571-j0.0499	-0.0339-j0.0098	-0.0361+j0.0162	0.0541-j0.0472	-0.0414-j0.0028	0.0402+j0.0284
43	0.0254+j0.0327	0.0336+j0.0218	0.0364+j0.0317	0.0250+j0.0444	0.0145+j0.0195	0.0417+j0.0262	0.0411+j0.0436	0.0282-j0.0239	0.0216+j0.0573
44	-0.0553+j0.0010	0.0577-j0.0849	-0.0817-j0.0368	0.0264-j0.1035	0.0267-j0.0250	-0.0793-j0.0438	0.0226-j0.1087	0.0148-j0.0251	-0.0060-j0.0064
45	0.0388-j0.0333	0.0275+j0.0792	0.0265-j0.0181	0.0474+j0.0883	-0.0936-j0.0208	0.0282-j0.0134	0.0453+j0.0905	-0.0901-j0.0192	-0.0233+j0.0283
46	-0.0175+j0.0221	0.0076-j0.0362	-0.0291+j0.0104	-0.0033+j0.0433	0.0327-j0.0580	-0.0271+j0.0225	0.0125+j0.0543	0.0346-j0.0590	-0.0079-j0.0045
47	-0.0027+j0.0341	-0.0318+j0.0028	-0.0115+j0.0348	-0.0500+j0.0338	-0.0453-j0.0261	-0.0082+j0.0245	-0.0285+j0.0339	-0.0529-j0.0171	-0.0055-j0.0450
48	-0.0651+j0.0130	0.0068-j0.0110	-0.0526+j0.0168	-0.0017+j0.0269	0.0377-j0.0197	-0.0516+j0.0234	-0.0091+j0.0193	0.0401-j0.0214	0.0126-j0.0068
49	-0.0144-j0.0090	-0.0429+j0.0708	-0.0236-j0.0148	-0.0472+j0.0554	-0.1004+j0.0349	-0.0201-j0.0263	-0.0279+j0.0665	-0.1002+j0.0356	-0.0211+j0.0305
50	0.0138+j0.0292	0.0552+j0.0007	0.0075+j0.0208	0.0348-j0.0027	0.0878-j0.0337	0.0029+j0.0384	0.0298-j0.0005	0.0908-j0.0431	-0.0040-j0.0159
51	0.0051-j0.0164	-0.0155-j0.0319	-0.0096-j0.0143	-0.0051-j0.0271	0.0121-j0.0175	-0.0074-j0.0198	-0.0094-j0.0321	0.0073-j0.0057	-0.0390-j0.0801

n	$N_{TX}=2$		$N_{TX}=3$			$N_{TX}=4$			
	h_1	h_2	h_1	h_2	h_3	h_1	h_2	h_3	h_4
52	0.0316-j0.0102	-0.0311-j0.0200	0.0194-j0.0003	-0.0375-j0.0075	0.0215+j0.0272	0.0063+j0.0011	-0.0423+j0.0058	0.0238+j0.0227	-0.0363+j0.0340
53	0.0151-j0.0249	0.1112+j0.0758	-0.0019-j0.0297	0.1114+j0.0689	0.0574+j0.0202	-0.0095-j0.0239	0.1175+j0.0629	0.0621+j0.0123	0.0000+j0.0104
54	-0.0074+j0.0144	0.0359+j0.0300	-0.0099+j0.0034	0.0183+j0.0028	0.0233+j0.0823	-0.0131+j0.0117	0.0007+j0.0022	0.0217+j0.0780	-0.0431-j0.0395
55	0.0317-j0.0189	-0.0004+j0.0000	0.0373+j0.0004	0.0039-j0.0187	0.0185-j0.0212	0.0365+j0.0050	-0.0003-j0.0056	0.0150-j0.0200	0.0296+j0.0585
56	0.0506+j0.0009	0.1122+j0.0658	0.0504+j0.0041	0.0969+j0.0775	0.0251+j0.0704	0.0614-j0.0123	0.0961+j0.0775	0.0298+j0.0636	0.0005+j0.0314
57	0.0413+j0.0186	-0.0340+j0.0650	0.0396+j0.0078	-0.0375+j0.0498	-0.0387-j0.0211	0.0199+j0.0308	-0.0342+j0.0347	-0.0417-j0.0142	-0.0879+j0.0294
58	-0.0218-j0.0459	-0.0472+j0.0367	-0.0280-j0.0447	-0.0777+j0.0331	-0.0156+j0.0313	-0.0288-j0.0496	-0.0584+j0.0244	-0.0049+j0.0294	0.0353-j0.0193
59	-0.0635-j0.0790	-0.0490+j0.0665	-0.0684-j0.0761	0.0574+j0.0589	-0.0131-j0.0118	-0.0569-j0.0760	0.0618+j0.0488	-0.0120-j0.0143	0.0256+j0.0276
60	0.0002-j0.0665	0.0144-j0.0037	0.0013-j0.0687	0.0109-j0.0109	-0.0195-j0.0356	-0.0029-j0.0749	0.0094-j0.0103	-0.0142-j0.0272	0.0653+j0.0968
61	-0.0110+j0.0071	0.0780-j0.0095	-0.0266+j0.0135	0.0641-j0.0317	0.0014+j0.0456	-0.0351+j0.0013	0.0690-j0.0288	-0.0087+j0.0500	0.0260-j0.0060
62	-0.0320+j0.0072	0.0143+j0.0539	-0.0276+j0.0057	-0.0058+j0.0511	0.0110+j0.0026	-0.0374+j0.0085	-0.0118+j0.0348	0.0184+j0.0114	0.0323-j0.0155
63	-0.0061-j0.0819	-0.0611-j0.0106	-0.0436-j0.0795	-0.0697-j0.0182	-0.0485+j0.0302	-0.0874-j0.0547	-0.0234-j0.0168	-0.0512-j0.0293	0.0025-j0.0020
64	0.0762-j0.0814	-0.0369+j0.0393	0.0698-j0.0933	-0.0316+j0.0295	0.0904+j0.0699	0.0676-j0.0855	-0.0220+j0.0329	0.0972+j0.0890	0.0015-j0.0066
65	0.0174+j0.0191	0.0945-j0.0140	0.0147+j0.0168	0.0957-j0.0299	-0.0286+j0.0004	0.0141+j0.0020	0.0963-j0.0196	-0.0258-j0.0021	-0.0344+j0.0180
66	-0.0698-j0.0311	0.0182-j0.0327	-0.0625-j0.0461	0.0137-j0.0455	-0.0297+j0.0070	-0.0583-j0.0240	0.0076-j0.0453	-0.0160+j0.0054	-0.0183+j0.0599
67	-0.0830-j0.0056	-0.0032-j0.0410	-0.0810-j0.0069	-0.0044-j0.0211	-0.0921-j0.0328	-0.0727+j0.0025	-0.0010+j0.0152	-0.0876-j0.0152	-0.0084-j0.0042
68	-0.0097-j0.0280	-0.1006+j0.0134	-0.0145-j0.0330	-0.0894+j0.0093	-0.0425+j0.0557	-0.0034-j0.0268	-0.1000+j0.0111	-0.0553+j0.0453	-0.0711-j0.0018
69	-0.0109-j0.0085	0.0526-j0.1420	-0.0062-j0.0128	0.0554-j0.1531	0.0766-j0.0651	-0.0029-j0.0087	0.0512-j0.1350	0.0790-j0.0639	-0.0218-j0.0898
70	-0.0552+j0.0284	0.0129+j0.0012	-0.0499+j0.0237	0.0222-j0.0039	-0.0009+j0.0275	-0.0646+j0.0253	0.0320+j0.0005	-0.0140+j0.0222	-0.0171-j0.0459
71	0.0061+j0.0184	-0.0032-j0.0237	-0.0014+j0.0290	-0.0145-j0.0322	0.0037-j0.0547	-0.0019+j0.0340	-0.0234-j0.0242	0.0795-j0.0535	0.0344+j0.0802
72	-0.0163+j0.0371	-0.1229+j0.0849	-0.0104+j0.0420	-0.1159+j0.0877	0.1048+j0.0251	-0.0122+j0.0312	-0.1218+j0.1005	0.1055+j0.0278	-0.0760+j0.0634
73	0.0668+j0.0585	0.0452-j0.0062	0.0406+j0.0562	0.0507+j0.0012	0.0894-j0.0730	0.0516+j0.0568	0.0513+j0.0074	0.0957-j0.0663	-0.0346-j0.0226
74	-0.0539-j0.0087	-0.0511+j0.0225	-0.0764-j0.0041	-0.0471+j0.0277	-0.0084-j0.1051	-0.0689-j0.0054	-0.0450+j0.0322	-0.0064-j0.1034	-0.0124-j0.0585
75	-0.0005-j0.0255	-0.0449-j0.0377	0.0070+j0.0200	-0.0506-j0.0361	-0.1391+j0.0839	0.0023+j0.0206	-0.0457-j0.0417	-0.1420-j0.0702	-0.0432-j0.0644
76	-0.0018+j0.0540	-0.0078+j0.0208	0.0039+j0.0623	0.0072+j0.0263	0.0437-j0.0193	0.0071+j0.0487	0.0226+j0.0302	0.0524-j0.0166	-0.0762-j0.0508
77	0.0266+j0.1584	-0.0057-j0.0098	0.0325+j0.1543	-0.0025-j0.0177	0.0022-j0.0410	0.0229+j0.1551	-0.0042-j0.0095	-0.0174-j0.0368	-0.0288-j0.0024
78	0.0391-j0.0546	-0.0526+j0.0390	0.0254-j0.0333	-0.0447+j0.0313	0.0307+j0.0856	0.0456-j0.0233	-0.0636+j0.0291	0.0305+j0.0873	0.0972+j0.0269
79	-0.0285-j0.1144	0.0603-j0.0091	-0.0331-j0.1260	0.0686+j0.0117	0.0037-j0.0202	-0.0221-j0.1167	0.0688+j0.0167	0.0137-j0.0178	0.0025-j0.0101
80	-0.0200-j0.0217	-0.0054+j0.0590	-0.0274-j0.0175	0.0058+j0.0581	0.0605+j0.0380	-0.0036-j0.0234	0.0092+j0.0675	0.0631+j0.0323	0.0278+j0.0907
81	-0.1922-j0.0431	0.0583-j0.0276	-0.1802+j0.0386	0.0462-j0.0329	0.0200-j0.0606	-0.1774-j0.0352	0.0504-j0.0324	0.0218-j0.0448	0.0737-j0.0002
82	-0.0887-j0.0415	-0.0347-j0.0286	-0.0826-j0.0474	-0.0295+j0.0021	0.0209+j0.0041	-0.0914-j0.0488	-0.0296+j0.0041	-0.0269-j0.0052	-0.0744-j0.0119
83	-0.0105-j0.0153	-0.0600+j0.0194	-0.0258-j0.0101	-0.0257+j0.0303	-0.0083-j0.0650	-0.0358-j0.0015	-0.0358+j0.0213	-0.0200-j0.0671	-0.0087+j0.0293
84	-0.0595-j0.0274	-0.0010+j0.0072	-0.0292-j0.0202	0.0089-j0.0029	-0.0048+j0.0147	-0.0459-j0.0274	0.0073-j0.0085	-0.0154+j0.0155	0.0091-j0.0154
85	0.0361-j0.0148	-0.0057-j0.0407	0.0240-j0.0226	-0.0159-j0.0158	0.0523+j0.0753	0.0158-j0.0174	-0.0088-j0.0135	0.0603+j0.0687	-0.0211+j0.0470
86	-0.0054+j0.0302	0.0432-j0.0783	0.0220+j0.0285	0.0659-j0.0864	0.0217-j0.0103	0.0203+j0.0313	0.0602-j0.0961	0.0208-j0.0089	-0.0259-j0.0374
87	0.0166-j0.0056	0.0234+j0.0464	0.0227-j0.0061	0.0261+j0.0398	0.0224+j0.0076	0.0291-j0.0062	0.0388+j0.0246	0.0244+j0.0041	-0.0365+j0.0115
88	-0.0272-j0.0169	0.0314+j0.0385	-0.0075+j0.0059	0.0223+j0.0414	-0.0859+j0.0419	-0.0112+j0.0039	0.0285+j0.0402	-0.0808+j0.0414	-0.1417-j0.0547
89	-0.0845+j0.0007	0.0422+j0.0630	-0.0633-j0.0120	0.0315+j0.0625	-0.0562-j0.0692	-0.0673-j0.0204	0.0256+j0.0598	-0.0620-j0.0623	-0.0717+j0.0396
90	-0.0234-j0.0606	0.0459-j0.0138	-0.0072+j0.0634	0.0268-j0.0225	-0.0042-j0.0299	-0.0190-j0.0629	0.0152-j0.0258	0.0267+j0.0448	0.0187+j0.0036
91	-0.0715-j0.0344	0.0434+j0.1201	-0.0747-j0.0503	0.0560+j0.1229	0.0196+j0.0285	-0.0741-j0.0483	0.0571+j0.1337	0.0269+j0.0228	-0.0888+j0.0405
92	0.0904+j0.0345	0.0294-j0.0702	0.1021+j0.0365	0.0180-j0.0793	0.0202-j0.1407	0.0910+j0.0376	0.0309-j0.0841	0.0126-j0.1322	-0.0574-j0.0049
93	-0.0377-j0.0186	-0.0677+j0.0032	-0.0387-j0.0253	-0.0775-j0.0089	0.0079-j0.1756	-0.0519-j0.0298	-0.0649-j0.0067	0.0072-j0.1659	-0.0518-j0.0061
94	-0.0193-j0.0167	0.0379-j0.0265	-0.0190-j0.0086	0.0208+j0.0134	-0.0528-j0.0365	0.0187+j0.0056	-0.0507-j0.0060	-0.0507-j0.0395	0.0202-j0.0141
95	0.0785+j0.0161	0.0332-j0.0218	0.0925-j0.0026	0.0352-j0.0306	-0.1356-j0.0097	0.0995-j0.0009	0.0298-j0.0296	-0.1385-j0.0139	-0.0533-j0.0075
96	-0.0205-j0.0282	-0.0077-j0.0185	-0.0192-j0.0061	-0.0008-j0.0056	-0.0179+j0.0041	-0.0163+j0.0086	0.0099-j0.0219	-0.0272+j0.0014	0.0206-j0.0127
97	-0.0373-j0.0270	0.1006+j0.0250	-0.0179-j0.0295	0.0968+j0.0162	-0.0175+j0.0530	-0.0276-j0.0308	0.0864+j0.0268	-0.0127+j0.0379	0.0621-j0.1175
98	-0.0798-j0.1285	0.1501-j0.0007	-0.0634-j0.1162	0.1337-j0.0187	0.1435+j0.0501	-0.0626+j0.1174	0.1200-j0.0282	0.1341+j0.0126	-0.1313-j0.0155
99	-0.0070+j0.1068	-0.0057-j0.0668	-0.0086+j0.1066	-0.0097-j0.0872	-0.0251+j0.0045	-0.0080+j0.1113	-0.0172-j0.0794	-0.0116-j0.0024	-0.0265+j0.0178
100	0.1014+j0.0033	-0.0199-j0.0404	0.1164-j0.0125	-0.0026-j0.0177	-0.0297-j0.0197	0.1088-j0.0207	-0.0092-j0.0296	-0.0320-j0.0221	-0.0194+j0.0200
101	-0.0322-j0.0503	0.0267+j0.0521	-0.0330-j0.0678	0.0288+j0.0528	0.0118+j0.0239	-0.0399-j0.0708	0.0288+j0.0582	0.0143+j0.0308	0.0274-j0.0186
102	0.0449+j0.1164	-0.0138+j0.0048	0.0361-j0.1303	-0.0186+j0.0019	0.0001-j0.0607	0.0527+j0.1480	-0.0240+j0.0075	0.0050-j0.0549	0.0177+j0.0390
103	-0.0837+j0.0089	0.0307-j0.0880	-0.0722+j0.0055	0.0252-j0.0790	0.0362+j0.0672	-0.0622-j0.0033	0.0306-j0.0892	0.0392+j0.0657	-0.0234+j0.0317
104	0.0767-j0.0548	0.0652-j0.0565	0.0765-j0.0633	0.0650+j0.0691	-0.0078-j0.0508	0.0701-j0.0610	0.0711+j0.0671	-0.0081-j0.0568	0.0089-j0.0008
105	0.0749+j0.0176	-0.0290-j0.1216	0.0801+j0.0101	-0.0285-j0.1187	-0.0297+j0.0046	0.0942+j0.0181	-0.0231-j0.1139	-0.0231+j0.0137	-0.0606-j0.0170
106	-0.0111-j0.0612	-0.0985+j0.0166	-0.0155-j0.0604	-0.1006+j0.0184	0.0222-j0.0018	-0.0106-j0.0759	-0.0977+j0.0218	0.0250-j0.0043	-0.0566+j0.0596
107	0.0415+j0.0154	-0.0584+j0.0611	0.0460-j0.0040	-0.0675+j0.0707	-0.0378+j0.0158	0.0476+j0.0020	-0.0753+j0.0668	-0.0278+j0.0171	0.0872-j0.1098
108	-0.0571+j0.0488	0.0113+j0.1151	-0.0541+j0.0487	0.0096+j0.0992	0.0262+j0.0463	-0.0402-j0.0468	0.0236-j0.1099	0.0166+j0.0358	0.0477-j0.0136
109	0.0505+j0.1136	0.0194+j0.0388	0.0762+j0.1252	0.0079+j0.0400	-0.0882-j0.0328	0.0710-j0.1213	0.0064+j0.0485	-0.0774-j0.0310	0.0887-j0.0408
110	0.0158+j0.0007	-0.0285+j0.0831	0.0262-j0.0261	-0.0326-j0.0988	0.0488-j0.0531	0.0390-j0.0065	-0.0175+j0.1053	0.0464-j0.0477	0.1657-j0.0408
111	-0.0648+j0.0715	-0.0233+j0.0246	-0.0705-j0.0612	-0.0202+j0.0068	-0.0234-j0.0290	-0.0622+j0.0677	-0.0145+j0.0059	-0.0226-j0.0205	-0.0307-j0.0767
112	0.0750+j0.0274	0.0403-j0.0920	0.0666+j0.0218	0.0375-j0.0783	-0.0133+j0.0278	0.0692+j0.0101	0.0530-j0.0856	-0.0268+j0.0262	-0.0776-j0.0526
113	-0.1055-j0.0100	-0.0303+j0.0736	-0.0930-j0.0127	-0.0111+j0.0627	-0.1071+j0.0391	-0.0946-j0.0057	-0.0101+j0.0664	-0.1065+j0.0432	-0.0856-j0.0313
114	-0.0026+j0.0536	0.0705-j0.0641	-0.0211+j0.0416	0.0643-j0.0670	0.0277+j0.0094	-0.0317+j0.0370	0.0534-j0.0607	0.0427-j0.0003	-0.0014+j0.0291
115	0.0586-j0.0059	0.0103-j0.0475	0.0489+j0.0103	0.0061-j0.0695	0.0234+j0.0454	0.0522+j0.0168	0.0027-j0.0533	0.0213+j0.0455	0.0812-j0.0323
116	0.0467-j0.0333	-0.1161-j0.0656	0.0547+j0.0219	-0.1313-j0.0666	-0.0869-j0.0849	0.0450+j0.0263	-0.1386-j0.0592	-0.0832-j0.0728	-0.0846-j0.1057
117	0.0458-j0.0547	0.0182-j0.0046	0.0406-j0.0510	0.0041-j0.0003	-0.1123+j0.0835	0.0403-j0.0497	-0.0098-j0.0105	-0.1055+j0.0820	-0.0551-j0.0410
118	-0.0488+j0.0044	-0.0357-j0.0162	-0.0610-j0.0032	-0.0214-j0.0243	0.0058+j0.0668	-0.0698-j0.0020	-0.0293-j0.0176	0.0307+j0.0616	-0.0377+j0.0158
119	0.0052-j0.1456	-0.0784-j0.0139	0.0174-j0.1520	-0.0860-j0.0068	0.0248-j0.0445	0.0136-j0.1523	-0.1022-j0.0058	0.0310-j0.0445	0.1031-j0.0823
120	-0.0093-j0.0251	0.0477-j0.0928	-0.0048-j0.0278	0.0457-j0.0899	-0.0160+j0.0586	-0.0092-j0.0333	0.0386-j0.0929	-0.0074+j0.0516	

n	$N_{TX}=2$		$N_{TX}=3$			$N_{TX}=4$			
	h_1	h_2	h_1	h_2	h_3	h_1	h_2	h_3	h_4
121	-0.0297-j0.1343	-0.0445+j0.0424	-0.0312-j0.1294	-0.0288+j0.0457	0.0533+j0.1065	-0.0302-j0.1293	-0.0250+j0.0395	0.0457+j0.1129	0.0298+j0.0468
122	-0.1614-j0.0594	0.1160-j0.0114	-0.1835+j0.0412	0.1070-j0.0230	-0.0375+j0.0816	-0.1819-j0.0251	0.1014-j0.0147	-0.0388+j0.0792	-0.0603-j0.0793
123	0.0151-j0.0335	-0.0406+j0.0022	0.0143-j0.0269	-0.0502-j0.0085	0.1120-j0.0408	0.0168-j0.0055	-0.0455-j0.0205	0.1166-j0.0501	0.1176+j0.0203
124	-0.0481-j0.0023	-0.0588+j0.0083	-0.0468-j0.0009	-0.0755-j0.0086	0.0768+j0.0141	-0.0513+j0.0073	-0.0699-j0.0078	0.0675+j0.0185	0.0036-j0.0357
125	0.1284-j0.0284	0.1201+j0.0709	0.1080-j0.0278	0.1177+j0.0525	-0.1202-j0.0365	0.0941-j0.0179	0.1111+j0.0509	-0.1232-j0.0267	-0.0224+j0.0801
126	0.0053+j0.0053	0.0719-j0.0576	-0.0166+j0.0021	0.0503-j0.0514	-0.0703-j0.0366	-0.0100-j0.0069	0.0550-j0.0562	-0.0747-j0.0479	-0.0650+j0.0651
127	0.0109+j0.0756	0.0269-j0.0645	0.0001+j0.0837	0.0223-j0.0592	-0.0003-j0.0631	0.0060+j0.0862	0.0116-j0.0573	-0.0015-j0.0661	-0.0464+j0.0179
128	0.0179+j0.0187	-0.0094-j0.0132	0.0418+j0.0247	0.0022-j0.0192	-0.0142-j0.0283	0.0444+j0.0322	0.0348-j0.0406	-0.0185-j0.0200	-0.1084+j0.1009
129	-0.0849+j0.0130	-0.0260+j0.0080	-0.0937+j0.0054	-0.0135-j0.0044	-0.0231-j0.0272	-0.0899+j0.0144	-0.0107-j0.0072	-0.0255-j0.0336	0.0186+j0.0074
130	0.0319-j0.0024	0.0712+j0.0184	0.0022-j0.0310	0.0899+j0.0276	0.0753-j0.0495	-0.0003-j0.0191	0.0956+j0.0168	0.0772-j0.0365	-0.0049+j0.0505
131	0.0061-j0.0114	-0.0098-j0.0490	0.0079-j0.0270	-0.0168-j0.0333	0.0223+j0.1358	0.0013-j0.0402	-0.0160-j0.0290	0.0150+j0.1393	-0.0724+j0.0740
132	0.0104-j0.0393	0.0169-j0.0200	-0.0614+j0.0397	0.0201-j0.0270	-0.0624-j0.0580	-0.0174-j0.0283	-0.0532-j0.0329	0.0138-j0.0271	-0.0412-j0.0707
133	0.0817+j0.0911	0.0203+j0.0482	0.0787+j0.0843	0.0118+j0.0374	-0.0073+j0.0303	0.0754+j0.0799	0.0265+j0.0422	0.0105+j0.0223	0.0256+j0.0078
134	-0.0037+j0.0605	-0.0081+j0.1039	-0.0033+j0.0474	-0.0057+j0.1278	-0.0350-j0.0312	0.0019+j0.0442	-0.0136+j0.1175	-0.0414-j0.0247	0.1163-j0.0532
135	-0.1555+j0.1231	-0.0098+j0.0478	-0.1693+j0.1235	-0.0035+j0.0442	-0.0489-j0.0041	-0.1632-j0.1292	0.0113+j0.0467	-0.0508-j0.0152	-0.0193-j0.0867
136	0.0104-j0.0311	0.0522-j0.1121	0.0122-j0.0348	0.0435-j0.0966	-0.0122-j0.0817	-0.0033-j0.0291	0.0348-j0.0961	-0.0185-j0.0904	-0.1084+j0.1063
137	0.0484-j0.0483	0.0408+j0.0629	0.0387-j0.0324	0.0481+j0.0619	0.0573+j0.0646	0.0383-j0.0287	0.0489+j0.0669	0.0574+j0.0713	0.0417-j0.0084
138	-0.0707-j0.0378	-0.0345+j0.0585	-0.0448-j0.0390	-0.0270-j0.0647	0.0364-j0.0137	-0.0484-j0.0328	-0.0121+j0.0693	0.0329-j0.0123	-0.1473-j0.0163
139	-0.0296-j0.0045	-0.0329+j0.0637	-0.0475-j0.0173	-0.0510+j0.0717	0.0049+j0.0492	-0.0322-j0.0234	-0.0607+j0.0727	-0.0088+j0.0524	0.0471+j0.0245
140	0.0104-j0.0154	0.0160-j0.0203	-0.0027-j0.0088	0.0150-j0.0242	-0.0027-j0.0627	-0.0061-j0.0265	0.0182-j0.0324	-0.0172-j0.0558	-0.0345+j0.0275
141	-0.0072-j0.0372	-0.0493-j0.0943	-0.0096-j0.0209	-0.0541-j0.0933	-0.0128-j0.0749	-0.0050-j0.0108	-0.0608-j0.0964	-0.0176-j0.0641	0.0811-j0.0023
142	-0.0587+j0.0054	0.0236-j0.0585	-0.0452-j0.0022	0.0074-j0.0543	0.0567-j0.0294	-0.0351+j0.0002	0.0113-j0.0474	0.0461-j0.0371	0.0889-j0.0048
143	-0.0199+j0.2233	-0.0631+j0.0471	-0.0217+j0.2017	-0.0476+j0.0423	0.0623+j0.1011	-0.0227+j0.2009	-0.0469+j0.0469	0.0703+j0.1032	0.0584+j0.0125
144	0.0575-j0.0194	0.0101-j0.0456	0.0453-j0.0255	0.0045-j0.0336	-0.0303+j0.0183	0.0349-j0.0280	0.0054-j0.0206	-0.0320+j0.0071	-0.0197-j0.0390
145	-0.0081-j0.0201	-0.0138+j0.0179	0.0117-j0.0240	-0.0098+j0.0224	0.0269+j0.0697	0.0191-j0.0241	-0.0110+j0.0124	0.0412+j0.0825	0.0107-j0.0147
146	-0.0102+j0.0222	-0.0227-j0.0014	-0.0084+j0.0352	-0.0402-j0.0055	-0.0031+j0.0668	-0.0037-j0.0320	-0.0400-j0.0097	0.0114+j0.0560	-0.0554-j0.0271
147	0.0369+j0.0553	0.0072+j0.0436	0.0314+j0.0585	0.0088+j0.0368	0.0580-j0.0482	0.0299+j0.0478	0.0029+j0.0327	0.0612-j0.0583	-0.0593-j0.0340
148	-0.0254+j0.0855	0.0784-j0.0961	-0.0147+j0.0617	0.0933-j0.0768	0.0086+j0.0708	-0.0168+j0.0554	0.0107-j0.0656	-0.0033+j0.0810	-0.0785-j0.0083
149	-0.0859+j0.0052	-0.0035-j0.0955	-0.0818+j0.0112	-0.0030-j0.0857	0.0217+j0.0084	-0.0853+j0.0271	-0.0125-j0.0844	0.0267+j0.0067	0.0780-j0.0940
150	0.0024-j0.1180	0.0078-j0.0019	0.0153-j0.1124	0.0169+j0.0099	-0.0453+j0.0194	0.0122-j0.1058	0.0095-j0.0143	-0.0649+j0.0093	0.0223+j0.1641
151	-0.0433-j0.0601	0.0166-j0.0644	-0.0542-j0.0647	-0.0096-j0.0692	-0.0693-j0.0918	-0.0472-j0.0635	-0.0060-j0.0671	-0.0820-j0.0942	0.1162-j0.0177
152	0.0338-j0.0535	0.0060-j0.0507	0.0387-j0.0697	0.0046-j0.0480	-0.0003-j0.0054	0.0330-j0.0822	0.0098-j0.0611	-0.0005-j0.0039	0.0019+j0.0079
153	0.0082-j0.0065	0.0093-j0.0139	0.0013-j0.0080	-0.0241-j0.0164	-0.0853-j0.0203	-0.0081-j0.0194	-0.0325-j0.0162	-0.0726-j0.0264	0.0028-j0.0016
154	0.0114+j0.0212	0.0398-j0.0278	0.0163+j0.0258	0.0245+j0.0362	-0.0377+j0.0002	0.0177+j0.0373	0.0254+j0.0433	-0.0392-j0.0038	-0.0185+j0.0874
155	0.0669+j0.0914	0.0575-j0.0057	0.0604-j0.0681	0.0285+j0.0048	-0.0319-j0.1253	0.0732+j0.0810	0.0294+j0.0107	-0.0386-j0.1308	-0.0081-j0.0029
156	-0.0076-j0.0434	-0.0053-j0.0052	-0.0043-j0.0310	-0.0206+j0.0028	0.0039-j0.0257	-0.0119-j0.0275	-0.0319+j0.0160	0.0072-j0.0195	-0.1267-j0.0138
157	-0.1692-j0.0465	0.0534-j0.0198	-0.1639-j0.0362	0.0289-j0.0211	-0.0704+j0.0516	-0.1534-j0.0349	0.0346-j0.0148	-0.0786+j0.0574	0.0145+j0.0262
158	0.0061-j0.0173	-0.0734+j0.0097	0.0066-j0.0128	-0.0816+j0.0201	0.0259+j0.0011	0.0106-j0.0138	-0.0849+j0.0119	0.0202-j0.0029	-0.0726+j0.0598
159	-0.0372-j0.0321	-0.1609+j0.0359	-0.0273+j0.0416	-0.1449-j0.0270	0.0336-j0.0439	-0.0240-j0.0397	-0.1517+j0.0193	0.0342-j0.0378	0.0454+j0.0029
160	-0.0847+j0.0183	-0.0013-j0.1555	-0.0722+j0.0292	-0.0024-j0.1677	-0.0019+j0.1157	-0.0689+j0.0332	-0.0099-j0.1525	-0.0011+j0.1198	-0.0273+j0.0298
161	-0.0148+j0.0309	-0.0824+j0.0782	-0.0326-j0.0257	-0.0629-j0.0872	0.0170+j0.1459	-0.0435-j0.0261	-0.0549+j0.0977	0.0202+j0.1299	-0.0009-j0.0804
162	-0.1216-j0.0398	0.0067-j0.0088	-0.1075-j0.0301	0.0209-j0.0268	0.0538+j0.0024	-0.1036-j0.0213	0.0163-j0.0293	0.0584+j0.0041	-0.0094+j0.0020
163	0.0472-j0.0588	-0.0857-j0.0026	0.0540-j0.0550	-0.0689-j0.0030	-0.0130-j0.0329	0.0646-j0.0473	-0.0692-j0.0100	-0.0159+j0.0202	-0.0091-j0.0600
164	-0.0243-j0.0721	-0.0223+j0.0247	-0.0210-j0.0760	-0.0246+j0.0289	0.0025+j0.0075	-0.0205-j0.0833	-0.0214+j0.0268	0.0091+j0.0178	-0.0389-j0.0208
165	-0.0627-j0.0034	0.0467-j0.0719	-0.0843+j0.0032	0.0570+j0.0683	0.0163-j0.0529	-0.0855+j0.0084	0.0630+j0.0659	0.0185-j0.0474	-0.0103-j0.0089
166	-0.0449-j0.0218	-0.0371-j0.0235	-0.0484-j0.0353	-0.0236+j0.0091	0.0152+j0.1191	-0.0499-j0.0329	-0.0328+j0.0053	0.0144+j0.1223	-0.0351+j0.0082
167	0.0586-j0.0129	0.1241-j0.0040	0.0611-j0.0004	0.1468-j0.0052	0.0377-j0.0726	0.0729-j0.0157	0.1390-j0.0042	0.0401+j0.0643	0.0990-j0.0370
168	-0.0841-j0.1519	-0.0691-j0.0179	-0.0873-j0.1528	-0.0256-j0.0040	0.0256-j0.0046	-0.0924-j0.1429	-0.0129+j0.0032	0.0179+j0.0047	0.0110+j0.0131
169	0.1192+j0.0433	-0.0694-j0.0322	0.1130+j0.0324	-0.0394-j0.0396	-0.0175+j0.0525	0.1104+j0.0347	-0.0456-j0.0309	-0.0192+j0.0552	-0.1548-j0.0949
170	0.0221-j0.0551	-0.0237-j0.0702	0.0239-j0.0506	-0.0086-j0.0762	0.0248-j0.0085	0.0309-j0.0577	-0.0114-j0.0780	-0.0144-j0.0140	0.1390+j0.0395
171	0.0011-j0.0331	-0.0382-j0.0010	-0.0057-j0.0426	-0.0559-j0.0037	0.0992+j0.0558	-0.0019-j0.0302	-0.0361-j0.0061	0.0939+j0.0553	0.0637+j0.0974
172	0.0077+j0.0482	0.0987+j0.0983	0.0094+j0.0433	0.0971+j0.0881	0.0660+j0.0236	-0.0015+j0.0362	0.1016+j0.0845	0.0667+j0.0266	0.1185-j0.0294
173	0.0634+j0.0303	0.0142+j0.0170	0.0779+j0.0424	-0.0250+j0.0422	-0.0761+j0.0151	0.0603+j0.0414	-0.0185+j0.0375	-0.0589+j0.0117	-0.0497-j0.0050
174	-0.0655-j0.0616	0.0795+j0.0375	-0.0453-j0.0686	0.0617+j0.0549	0.0410-j0.0222	-0.0494-j0.0734	0.0561+j0.0548	0.0418-j0.0183	0.0020+j0.0127
175	-0.0098-j0.0318	-0.0703-j0.0213	-0.0141-j0.0384	-0.0982+j0.0005	0.0590+j0.0093	-0.0120-j0.0379	-0.0945+j0.0013	0.0583+j0.0065	0.0349+j0.0165
176	0.0003-j0.0170	0.0191-j0.0326	0.0009-j0.0171	0.0371-j0.0353	-0.0004+j0.0330	0.0004-j0.0254	0.0399-j0.0431	0.0014+j0.0365	0.0555-j0.0116
177	-0.0281+j0.0317	-0.0402-j0.0195	-0.0260+j0.0515	-0.0202-j0.0135	0.0649+j0.0620	-0.0266+j0.0435	-0.0148-j0.0108	0.0670+j0.0566	-0.0109+j0.0746
178	-0.0389+j0.0493	-0.0722-j0.0347	-0.0537-j0.0259	-0.0738-j0.0271	-0.0426-j0.0069	-0.0488-j0.0352	-0.0760-j0.0227	-0.0439-j0.0116	-0.0719+j0.0407
179	0.0888+j0.0021	0.0038-j0.0505	0.1000-j0.0170	-0.0150+j0.0348	-0.0110+j0.0108	0.1058-j0.0267	-0.0134+j0.0459	-0.0124+j0.0081	0.0912-j0.0295
180	0.0174-j0.0422	-0.0703+j0.0704	0.0177-j0.0343	-0.0879+j0.0849	0.0210-j0.0116	0.0173-j0.0380	-0.0696+j0.0830	0.0177-j0.0293	-0.1047-j0.0247
181	0.0724+j0.0211	-0.0400+j0.0791	0.0729+j0.0267	-0.0230+j0.0642	-0.0669+j0.0569	0.0812+j0.0322	-0.0221+j0.0703	-0.0724+j0.0590	0.0595-j0.0057
182	0.0177-j0.0137	-0.0438-j0.1108	0.0347-j0.0025	-0.0425-j0.1001	0.0071-j0.0049	0.0258+j0.0056	-0.0422-j0.1036	0.0115-j0.0082	0.0540-j0.0299
183	0.0176+j0.0210	0.0007+j0.0204	0.0127+j0.0253	0.0341+j0.0200	-0.0207-j0.0154	0.0144+j0.0159	0.0373+j0.0137	-0.0267+j0.0039	-0.0337-j0.0118
184	0.0103-j0.0242	-0.0389-j0.0243	0.0169+j0.0058	-0.0240-j0.0101	-0.0979+j0.0411	0.0149+j0.0106	-0.0222-j0.0047	-0.0838+j0.0484	0.0949-j0.0806
185	-0.0493-j0.0425	0.0126-j0.0136	-0.0396-j0.0369	0.0172-j0.0061	0.0491+j0.0319	-0.0484-j0.0422	0.0168+j0.0170	0.0519+j0.0317	-0.0282+j0.0736
186	0.0317-j0.0938	0.1022-j0.0397	0.0277-j0.0957	0.1050-j0.0404	-0.0284+j0.0140	0.0146-j0.0976	0.1070-j0.0484	-0.0288+j0.0090	0.0260-j0.0386
187	0.0321+j0.0157	0.0214+j0.1137	0.0200+j0.0116	0.0082+j0.1332	-0.0762+j0.0748	0.0217+j0.0224	0.0021+j0.1277	-0.0736+j0.0737	0.0868+j0.0786
188	-0.0674-j0.0269	-0.0226+j0.0733	-0.0572-j0.0277	-0.0019+j0.0629	-0.0723+j0.0291	-0.0622-j0.0254	0.0101+j0.0724	-0.0842+j0.0166	-0.0041-j0.0161
189	0.0594-j0.0010	-0.0638-j0.0740	0.0446-j0.0165	-0.0665-j0.0687	-0.1319-j0.0100	0.04			

n	$N_{TX}=2$		$N_{TX}=3$			$N_{TX}=4$			
	h_1	h_2	h_1	h_2	h_3	h_1	h_2	h_3	h_4
190	0.0275+j0.0796	0.0503+j0.0227	0.0166+j0.0693	0.0794+j0.0071	-0.0602-j0.0470	0.0223+j0.0752	0.0776+j0.0021	-0.0482-j0.0541	-0.0150-j0.1164
191	-0.0422+j0.0024	0.0187-j0.0026	-0.0497-j0.0294	0.0007-j0.0082	0.0365-j0.0101	-0.0536+j0.0136	-0.0003-j0.0222	0.0330-j0.0078	-0.0010+j0.0316
192	0.0128-j0.0425	0.0239-j0.0151	0.0200-j0.0486	0.0285-j0.0298	-0.0518+j0.0999	0.0261-j0.0386	0.0137-j0.0263	-0.0502+j0.1074	-0.0402-j0.0263
193	0.0095+j0.0124	0.0727+j0.0336	0.0217+j0.0014	0.0588+j0.0246	-0.0264-j0.0501	0.0222-j0.0023	0.0611+j0.0247	-0.0202-j0.0499	0.0195-j0.0416
194	-0.0093-j0.0187	0.0205+j0.0658	-0.0288-j0.0162	-0.0006+j0.0671	-0.0346-j0.0091	-0.0280-j0.0185	-0.0122+j0.0609	-0.0393-j0.0030	0.0462-j0.0085
195	0.0284-j0.0222	0.0344+j0.0325	0.0267-j0.0192	0.0164+j0.0152	-0.0037+j0.0303	0.0213-j0.0039	0.0219+j0.0131	-0.0041+j0.0345	-0.0013+j0.0083
196	0.0003-j0.0051	-0.0090-j0.0018	0.0130-j0.0113	-0.0104-j0.0073	0.0188-j0.0382	0.0238-j0.0043	-0.0120-j0.0151	0.0255-j0.0323	0.0473-j0.0001
197	-0.0309+j0.0301	-0.0400+j0.0165	0.0261+j0.0148	0.0115-j0.0268	-0.0115-j0.0178	-0.0264+j0.0105	0.0236-j0.0190	-0.0610-j0.0145	-0.0198-j0.0593
198	-0.0119+j0.0321	-0.0239-j0.0247	-0.0077+j0.0362	-0.0158-j0.0287	0.0162+j0.0476	-0.0012+j0.0556	-0.0021-j0.0433	0.0197+j0.0492	0.0399+j0.0305
199	-0.0168-j0.0029	0.0152+j0.0166	-0.0126-j0.0088	0.0239-j0.0027	0.0451-j0.0400	-0.0148-j0.0191	0.0209-j0.0087	0.0438-j0.0425	-0.0264-j0.0572
200	-0.0005+j0.0212	-0.0063-j0.0585	-0.0037+j0.0234	-0.0232-j0.0698	-0.0468+j0.0327	-0.0112+j0.0218	-0.0177-j0.0797	-0.0535+j0.0342	0.0387-j0.0018
201	-0.0300-j0.0279	-0.0400+j0.0258	-0.0291+j0.0419	-0.0193-j0.0157	-0.0019-j0.0444	-0.0029-j0.0460	-0.0266+j0.0221	0.0051+j0.0040	-0.0857-j0.0098
202	0.0030-j0.0286	0.0200-j0.0259	-0.0118-j0.0150	0.0189-j0.0266	0.0426+j0.0093	-0.0083-j0.0179	0.0276-j0.0203	0.0502+j0.0121	-0.0581-j0.0174
203	0.0259-j0.0401	-0.0428+j0.0083	0.0271-j0.0399	-0.0346+j0.0221	-0.0286+j0.0071	0.0381-j0.0502	-0.0296+j0.0109	-0.0407+j0.0151	0.0857-j0.0301
204	-0.0012+j0.0127	0.0151-j0.0258	-0.0121+j0.0032	0.0152-j0.0248	-0.0309-j0.0092	-0.0122+j0.0119	0.0119-j0.0177	-0.0401-j0.0054	-0.0047+j0.0318
205	-0.0093-j0.0073	0.0086-j0.0107	-0.0013-j0.0016	0.0249+j0.0116	0.0002-j0.0121	-0.0064+j0.0024	0.0224+j0.0098	-0.0071-j0.0411	
206	-0.0100-j0.0059	0.0368+j0.0410	0.0084-j0.0097	0.0519+j0.0550	0.0177-j0.0057	0.0007-j0.0033	0.0411+j0.0575	0.0193+j0.0040	0.0157-j0.0136
207	-0.0290+j0.0482	0.0339-j0.0077	-0.0451+j0.0443	0.0259+j0.0332	0.0381-j0.0057	-0.0437-j0.0369	0.0389+j0.0251	0.0305-j0.0091	-0.0672-j0.0296
208	-0.0415+j0.0294	-0.0005+j0.0073	-0.0418+j0.0570	0.0395-j0.0015	-0.0155+j0.0047	-0.0468+j0.0519	0.0300+j0.0071	-0.0145+j0.0101	0.0063+j0.0325
209	-0.0072-j0.0452	0.0138-j0.0317	-0.0074-j0.0479	0.0087-j0.0280	-0.0199-j0.0427	0.0014-j0.0422	0.0106-j0.0328	-0.0102-j0.0379	0.0022+j0.0659
210	-0.0037-j0.0259	-0.0218+j0.0017	-0.0110-j0.0353	0.0015-j0.0216	0.0336-j0.0453	0.0029-j0.0339	-0.0148-j0.0189	0.0358-j0.0500	-0.0320-j0.0227
211	-0.0238-j0.0300	-0.0089-j0.0010	-0.0296+j0.0323	-0.0233-j0.0243	0.0236-j0.0113	-0.0288+j0.0223	-0.0229-j0.0278	0.0188-j0.0027	-0.0199-j0.0471
212	0.0270-j0.0398	0.0143+j0.0550	0.0311-j0.0309	0.0148+j0.0589	0.0058-j0.0313	0.0145-j0.0327	-0.0030+j0.0476	0.0091-j0.0166	-0.0331+j0.0026
213	0.0298+j0.0227	0.0341-j0.0227	0.0226+j0.0182	0.0122-j0.0175	0.0267-j0.0149	0.0238+j0.0242	0.0127-j0.0214	0.0185-j0.0087	-0.0280-j0.0228
214	-0.0142+j0.0130	-0.0066-j0.0270	-0.0110+j0.0048	-0.0142-j0.0128	-0.0090+j0.0204	-0.0043+j0.0048	-0.0086-j0.0198	-0.0185+j0.0229	-0.0103-j0.0005
215	-0.0046-j0.0189	0.0312-j0.0149	-0.0075-j0.0243	0.0437-j0.0276	-0.0159+j0.0128	-0.0117-j0.0185	0.0357-j0.0229	-0.0081+j0.0080	-0.0375-j0.0327
216	0.0017-j0.0298	0.0246-j0.0301	-0.0034-j0.0296	0.0127-j0.0329	0.0109-j0.0014	-0.0012-j0.0296	0.0305-j0.0416	0.0103-j0.0002	-0.0207-j0.0002
217	0.0026-j0.0097	0.0039+j0.0004	0.0066-j0.0163	0.0097+j0.0065	-0.0308+j0.0018	0.0078-j0.0234	-0.0011+j0.0044	-0.0278-j0.0017	0.0006-j0.0300
218	0.0260-j0.0108	0.0133-j0.0151	0.0301-j0.0276	0.0053-j0.0199	-0.0089+j0.0047	0.0232-j0.0268	0.0051-j0.0390	-0.0086+j0.0020	0.0313-j0.0094
219	0.0105+j0.0164	-0.0198+j0.0153	-0.0012-j0.0204	-0.0337+j0.0096	-0.0033+j0.0279	-0.0131+j0.0102	-0.0337-j0.0131	-0.0058+j0.0267	-0.0429+j0.0186
220	0.0120-j0.0159	-0.0092-j0.0096	0.0144-j0.0319	-0.0270-j0.0152	-0.0199-j0.0005	0.0147-j0.0376	-0.0243-j0.0181	-0.0254-j0.0042	0.0275-j0.0011
221	0.0331-j0.0039	-0.0429-j0.0106	0.0366-j0.0166	-0.0427-j0.0096	-0.0130-j0.0374	0.0345-j0.0043	-0.0384+j0.0004	-0.0116-j0.0383	0.0068+j0.0368
222	-0.0298-j0.0136	0.0097-j0.0737	-0.0130-j0.0112	0.0130-j0.0695	0.0131+j0.0205	-0.0098-j0.0122	0.0128-j0.0635	0.0108+j0.0329	-0.0257-j0.0128
223	0.0280+j0.0142	0.0046-j0.0130	0.0272+j0.0151	0.0180-j0.0015	-0.0130+j0.0354	0.0235-j0.0001	0.0252-j0.0093	-0.0202+j0.0263	-0.0148+j0.0089
224	0.0106+j0.0348	0.0129-j0.0058	0.0137+j0.0274	0.0152-j0.0091	-0.0193-j0.0178	-0.0117+j0.0275	0.0063+j0.0004	-0.0184-j0.0273	-0.0331+j0.0263
225	-0.0280+j0.0100	0.0170-j0.0132	-0.0393+j0.0249	-0.0013-j0.0065	-0.0342+j0.0057	-0.0366+j0.0143	0.0024-j0.0111	-0.0317+j0.0100	-0.0043+j0.0231
226	-0.0124-j0.0233	-0.0002+j0.0411	-0.0048-j0.0319	-0.0011+j0.0314	0.0141-j0.0183	-0.0001-j0.0301	-0.0090+j0.0421	0.0196-j0.0292	0.0055+j0.0115
227	0.0088+j0.0097	-0.0181+j0.0117	0.0107+j0.0053	-0.0328+j0.0188	0.0017-j0.0167	0.0227+j0.0184	-0.0289+j0.0131	-0.0052-j0.0148	0.0199-j0.0391
228	-0.0110-j0.0159	-0.0029-j0.0156	-0.0056-j0.0216	-0.0220-j0.0128	-0.0351-j0.0126	-0.0073-j0.0195	-0.0206+j0.0193	-0.0308+j0.0140	-0.0201-j0.0412
229	0.0194-j0.0227	0.0171-j0.0348	0.0226-j0.0259	0.0021-j0.0353	-0.0064-j0.0034	0.0278-j0.0195	-0.0057-j0.0389	-0.0090-j0.0070	-0.0018+j0.0373
230	0.0193+j0.0144	-0.0171+j0.0149	0.0116+j0.0031	0.0068-j0.0003	0.0078-j0.0102	0.0095-j0.0022	0.0056-j0.0005	0.0127-j0.0124	-0.0171+j0.0203
231	0.0087+j0.0212	-0.0010-j0.0102	0.0016+j0.0153	0.0081-j0.0041	-0.0159+j0.0141	-0.0081+j0.0198	-0.0024+j0.0033	-0.0128+j0.0053	0.0143-j0.0111
232	-0.0011-j0.0032	-0.0067+j0.0091	0.0231-j0.0165	-0.0087-j0.0017	-0.0029-j0.0209	0.0206-j0.0085	-0.0068+j0.0040	-0.0087-j0.0211	-0.0017-j0.0153
233	0.0008-j0.0128	0.0035+j0.0365	0.0008-j0.0113	0.0058+j0.0142	0.0256-j0.0014	-0.0043-j0.0150	-0.0015+j0.0212	0.0289+j0.0034	0.0006+j0.0331
234	-0.0143+j0.0075	-0.0154-j0.0095	-0.0108-j0.0108	-0.0212-j0.0038	-0.0088+j0.0150	0.0038+j0.0112	-0.0220-j0.0047	-0.0091-j0.0004	-0.0093-j0.0003
235	0.0067+j0.0023	-0.0002+j0.0072	0.0191+j0.0025	0.0021-j0.0034	-0.0086-j0.0279	0.0204+j0.0041	0.0031+j0.0026	-0.0156-j0.0245	-0.0059-j0.0063
236	0.0048-j0.0023	0.0148-j0.0097	-0.0050+j0.0091	0.0088-j0.0018	-0.0030-j0.0175	-0.0062-j0.0044	0.0070-j0.0146	0.0092-j0.0066	-0.0174+j0.0213
237	0.0019+j0.0119	-0.0171+j0.0066	-0.0096+j0.0202	-0.0041+j0.0040	0.0255-j0.0158	-0.0074+j0.0108	-0.0035-j0.0004	0.0224-j0.0202	0.0157-j0.0087
238	0.0062-j0.0109	0.0117-j0.0174	0.0193-j0.0312	0.0154-j0.0112	0.0069-j0.0032	0.0211-j0.0214	0.0091-j0.0077	0.0037-j0.0032	0.0032+j0.0060
239	0.0046-j0.0070	-0.0061-j0.0079	0.0156-j0.0061	-0.0038+j0.0045	-0.0011+j0.0091	0.0184-j0.0080	0.0033+j0.0068	0.0033+j0.0121	0.0102-j0.0135
240	0.0029+j0.0001	-0.0015-j0.0015	-0.0002-j0.0026	0.0004-j0.0105	-0.0081-j0.0122	0.0038+j0.0089	-0.0061-j0.0087	-0.0031-j0.0144	-0.0061+j0.0076
241	-0.0022+j0.0163	-0.0070-j0.0044	0.0108+j0.0230	-0.0160-j0.0010	-0.0012-j0.0213	0.0050+j0.0260	-0.0139-j0.0002	-0.0002-j0.0118	0.0368+j0.0192
242	-0.0295+j0.0057	-0.0049-j0.0038	-0.0212+j0.0071	-0.0099-j0.0058	0.0165+j0.0158	-0.0251+j0.0103	-0.0114+j0.0032	0.0163-j0.0145	0.0034+j0.0037
243	-0.0101-j0.0004	-0.0119-j0.0071	-0.0185-j0.0032	-0.0224+j0.0001	0.0004-j0.0053	-0.0140-j0.0046	-0.0124-j0.0053	0.0008-j0.0097	-0.0199-j0.0199
244	0.0114+j0.0042	-0.0049-j0.0088	0.0123-j0.0045	-0.0095-j0.0042	-0.0204-j0.0001	0.0102-j0.0027	-0.0035-j0.0025	-0.0129-j0.0002	-0.0065-j0.0138
245	-0.0068-j0.0129	0.0226-j0.0010	-0.0010-j0.0055	0.0204+j0.0067	-0.0004-j0.0044	-0.0022+j0.0001	0.0208+j0.0024	-0.0003-j0.0054	0.0144+j0.0109
246	0.0088-j0.0014	-0.0028+j0.0009	0.0232-j0.0064	0.0001+j0.0198	0.0019-j0.0211	0.0288+j0.0004	0.0006+j0.0152	0.0086-j0.0256	-0.0062+j0.0088
247	0.0313+j0.0246	0.0186-j0.0140	0.0365+j0.0228	0.0130+j0.0022	0.0152-j0.0104	0.0359+j0.0226	0.0058+j0.0051	0.0285-j0.0079	-0.0054+j0.0072
248	0.0066+j0.0117	0.0041-j0.0084	0.0001+j0.0158	-0.0015+j0.0028	0.0322+j0.0028	-0.0069+j0.0128	-0.0016+j0.0084	0.0262-j0.0063	0.0274-j0.0110
249	-0.0040+j0.0040	-0.0156+j0.0193	0.0126+j0.0173	-0.0116+j0.0104	-0.0033+j0.0097	0.0070+j0.0100	-0.0100+j0.0088	-0.0029+j0.0076	0.0147-j0.0075
250	-0.0100+j0.0104	-0.0136-j0.0069	-0.0084+j0.0106	-0.0090-j0.0136	-0.0019+j0.0100	-0.0129+j0.0045	-0.0045-j0.0140	0.0045+j0.0081	0.0022-j0.0041
251	-0.0125-j0.0134	-0.0173-j0.0058	-0.0184-j0.0067	-0.0215-j0.0125	0.0099-j0.0165	-0.0151-j0.0074	-0.0190-j0.0092	0.0050-j0.0155	0.0092-j0.0105
252	-0.0138-j0.0121	0.0017+j0.0120	-0.0067-j0.0112	0.0023+j0.0051	0.0045-j0.0186	-0.0007-j0.0046	0.0034+j0.0046	-0.0008-j0.0144	-0.0046+j0.0081
253	0.0010+j0.0004	-0.0063+j0.0088	0.0002+j0.0045	-0.0128+j0.0100	0.0165+j0.0075	-0.0020+j0.0061	-0.0031+j0.0174	0.0179+j0.0127	0.0018-j0.0135
254	-0.0000+j0.0090	0.0119+j0.0029	-0.0115+j0.0071	0.0076+j0.0087	0.0158+j0.0100	-0.0150+j0.0070	0.0075+j0.0059	0.0155+j0.0098	0.0255+j0.0003
255	-0.0002-j0.0013	0.0166+j0.0096	0.0020-j0.0006	0.0229+j0.0085	-0.0073+j0.0084	-0.0005-j0.0001	0.0212-j0.0115	-0.0062+j0.0095	-0.0089-j0.0243

Annex K: Channel Bonding

K.1 INTRODUCTION

In channel bonding, data of a single PLP connection is spread over two or more different RF channels. Primarily channel bonding enables total service data rates that exceed the net capacity of a single RF channel, but it can also be used to exploit the frequency diversity among multiple RF channels. In this Annex the description is of channel bonding for two channels. The two RF channels may be located at any channel frequency, not necessarily adjacent to each other. The use of channel bonding is optional, but when it is used it shall conform to the description in this Annex.

Channel bonding is compatible with other features including MIMO, LDM, PAPR reduction, MISO, and so on.

Channel bonding is processed transparently, such that the output stream on the receiver side is equal to the corresponding input stream on the transmitter side.

Figure K.1.1 shows a simple block diagram of a channel bonded system.

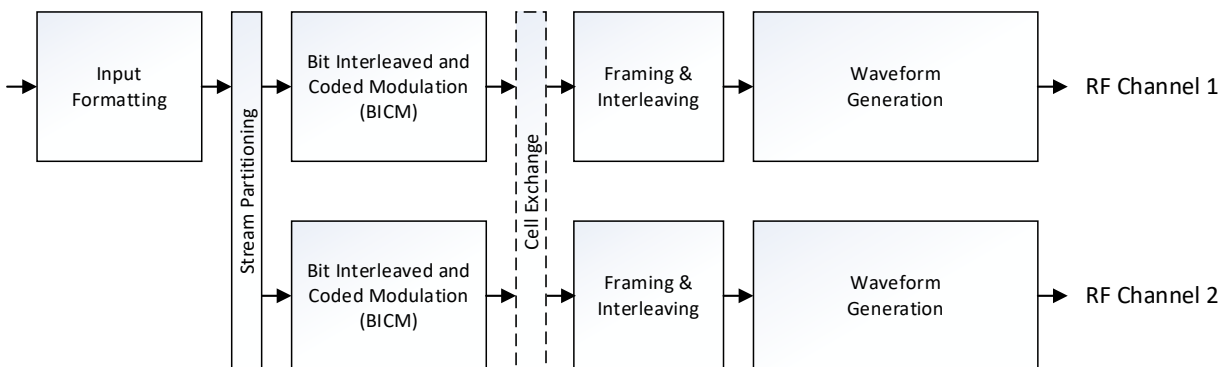

Figure K.1.1 Simple block diagram of channel bonding.

All data packets of a PLP transmitted in channel bonding mode shall pass through a common input formatting block (i.e., utilizes same **L1D_plp_id** value on all RF channels), where the Baseband Header of the Baseband Packet is inserted. **L1D_rf_id** can be used in combination with **L1D_plp_id** to uniquely identify the partitioned stream for each RF channel. When channel bonding is used, the Baseband Header extension **counter** shall always be used (see Section 5.2.2.3.1 for details). This allows for correct reordering of the packets from different RF channels at the receiver side even in the presence of different delays on each RF channel. The ordering of Baseband Packets shall be maintained. At the output of the stream partitioning block, the Baseband Packets of the bonded PLP for each of the two partitioned streams shall be FEC encoded, bit-interleaved and modulated individually and transmitted on different RF channels. The use of channel bonding does not depend on the cell multiplexing method, channel bonding may be used with any valid multiplexing method, including LDM.

Since there are two BICM chains used in channel bonding, the total required TI memory will be twice that of a single chain. When channel bonding is used with MIMO, the total required TI

memory will be four times of that required for a single transmitter chain engaged with a single Polarization.

Figure K.1.2 shows the transmitter side processing for channel bonding, with the joint input formatting stage showing Baseband Header insertion followed by stream partitioning.

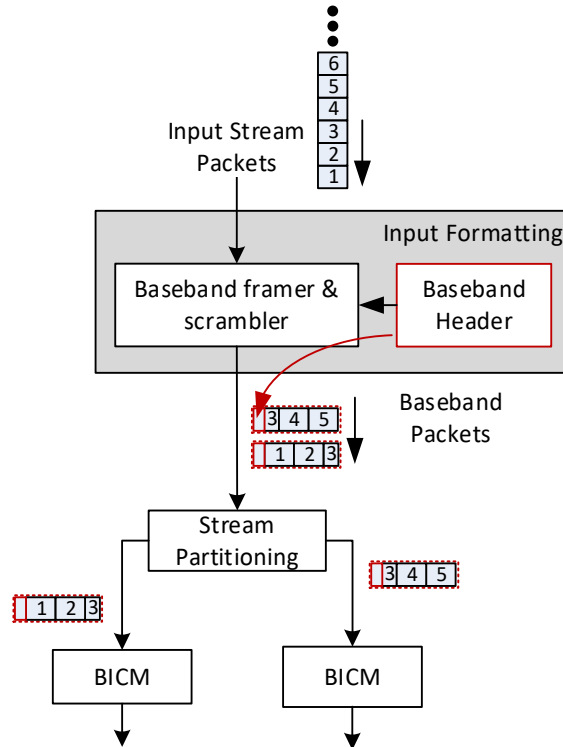

Figure K.1.2 Transmitter side processing for channel bonding.

Channel bonding is possible in two operation modes, which can be selected by `L1D_plp_channel_bonding_format` as described in Table 9.25. The first mode is Plain Channel Bonding and is described in Section K.2, the second is Channel Bonding with SNR Averaging and is described in Section K.3.

K.2 PLAIN CHANNEL BONDING

For plain channel bonding, the cell exchange stage in Figure K.3.1 shall be disabled, that is the two transmitter chains shall operate without any interaction after stream partitioning.

For plain channel bonding, each RF channel may use different parameter settings such as bandwidth, modulation, coding, FFT, guard interval length, and so on. Each RF channel is effectively handled as a standalone signal.

When bonded RF channels are configured with different BICM parameters for a channel-bonded PLP, the Baseband Packets for that channel-bonded PLP may have a different length on each of those bonded RF channels. When creating a Baseband Packet for a channel-bonded PLP, the Input Formatting block shall use the Baseband Packet length corresponding to the channel-bonded PLP's BICM parameters for the RF channel over which that Baseband Packet will be processed and transmitted.

In order to limit the memory size of the reconstruction circuit at the receiver side, load balancing is applied in the stream partitioner for plain channel bonding: The Baseband Packets shall be assigned to the two different modulation and encoding chains of the RF channel in proportion to their respective PLP rates. For example, if the same PLP rate is used in the two RF channels, Baseband Packets are equally split between the two RF channels. Note that PLP rate refers to uncoded PLP payload bitrate, i.e., the net data rate before Baseband Packet Header insertion and FEC encoding.

In addition, no more than 5 consecutive Baseband Packets shall be allocated to the same RF channel.

As an example, this mode can be used for different robustness levels across two RF channels to compensate for differing propagation characteristics, for example on one VHF and one UHF channel.

K.3 CHANNEL BONDING WITH SNR AVERAGING

When channel bonding with SNR averaging is used, the cell exchange block after the BICM stages shall be enabled. This bonding mode is intended to improve the PLP performance by increased diversity across the two RF channels.

For channel bonding with SNR averaging, the PLP rate on each RF path shall be the same. The stream partitioning block shall create Baseband Packets in an alternating way for the two BICM encoders.

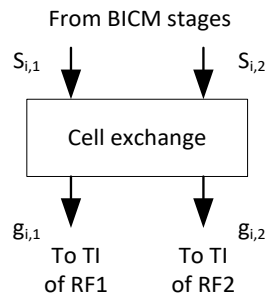

Figure K.3.1 Cell exchange block.

The cell exchange shall be applied on PLP level and shall multiply the vector including both cells for each input path at index i ($i = 0 \dots N_{\text{cells}} - 1$) by a cell exchange matrix:

$$\begin{pmatrix} g_{i,1} \\ g_{i,2} \end{pmatrix} = \begin{pmatrix} 1 & 0 \\ 0 & 1 \end{pmatrix} \cdot \begin{pmatrix} S_{i,1} \\ S_{i,2} \end{pmatrix} \text{ for } i \text{ even}$$

$$\begin{pmatrix} g_{i,1} \\ g_{i,2} \end{pmatrix} = \begin{pmatrix} 0 & 1 \\ 1 & 0 \end{pmatrix} \cdot \begin{pmatrix} S_{i,1} \\ S_{i,2} \end{pmatrix} \text{ for } i \text{ odd,}$$

with, $s_{i,1}$ and $s_{i,2}$ defined as the input cells of the cell exchange and $g_{i,1}$ and $g_{i,2}$ defined as the output cells towards the time interleavers of the RF channels RF 1 and RF 2. RF 1 and RF 2 shall be used as listed by the parameter **L1D_rf_id** in the RF frequency loop of the L1-Detail signaling.

As a result, every second cell of each channel-bonded BICM encoder is sent to the other transmitter signal. This provides SNR averaging across the two RF channels used and results in an overall improved decoding performance of channel bonded PLPs, due to increased diversity.

To enable low-complexity cell re-exchange on the receiver side, the framing of both RF channels shall be synchronized. This includes time synchronicity for bootstrap, Preamble, same OFDM waveform parameters as well as the same scheduling of the PLP in the payload Frame. In this mode, the PLP of each RF channel shall use the same ModCod setting, same Inner Code and Outer Code, same MIMO setting, number of FEC Blocks per Subframe as well as TI mode and configuration.

K.4 CELL/PLP MULTIPLEXING

At least one RF channel of channel-bonded RF channels may be composed of multiple PLPs that are multiplexed within the RF channel by FDM, LDM, TDM, and their combination manners as described in Section 7.2. In this case, channel-bonded PLP(s) can be multiplexed with other PLPs not using channel bonding. LDM combines two cells belonging to different PLPs in the same RF channel, and the combined cell is treated as and mapped to a single cell within a Subframe in Framing. In addition, since channel bonding combines two PLPs of different RF channels and is independently applied to each PLP, LDM Combining shall be done after cell exchange. Therefore, whether to use channel bonding for Core PLP and Enhanced PLP can be determined independently.

Figure K.4.1 shows a simple block diagram of channel bonding with use of LDM. Dashed lines show blocks specific to channel bonding with SNR averaging, and dotted lines show blocks enabled by the inclusion of layered division multiplexed PLP(s) in channel bonding process.

When plain channel bonding is used, two PLPs in different RF channels can be bonded while having different scheduling parameters including layer setting, multiplexing scheme, and framing information such as PLP size, PLP start, PLP type, and so on. When channel bonding with SNR averaging is used, the two mutually bonded PLPs shall be configured with the same scheduling parameters, including the layer indices of PLPs, in order to achieve low complexity. This means that Core PLP shall be channel-bonded only with Core PLP, and Enhanced PLP shall be channel-bonded only with Enhanced PLP, respectively.

When channel-bonded and nonbonded PLPs assemble a complete delivered product, while all involved PLPs use SISO, the total TI memory required for the complete delivered product shall be twice the amount specified in Section 7.1.2. Simultaneously, for each RF channel, the group of PLPs consisting of all nonbonded PLPs within this complete delivered product shall individually satisfy the TI memory constraint specified in Section 7.1.2. When any MIMO PLP is included in the complete delivered product consisting of channel-bonded and nonbonded PLPs, the overall TI memory increases to four times the amount described in Section 7.1.2.

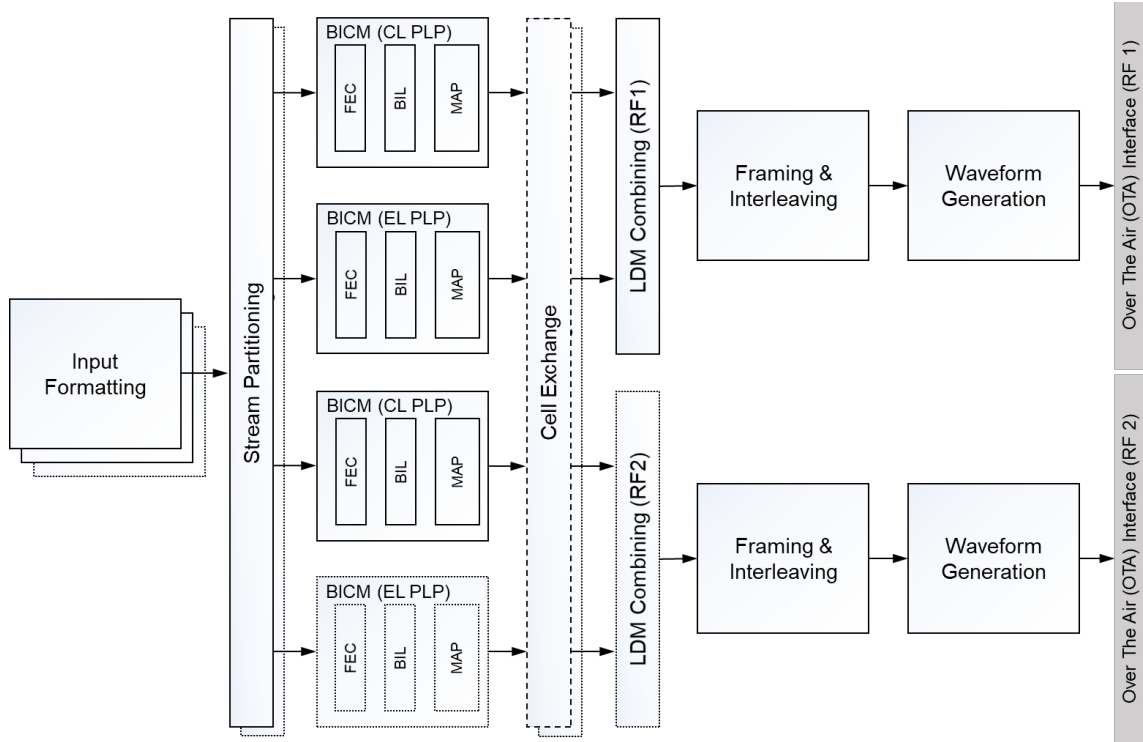

Figure K.4.1 Block diagram of channel bonding with LDM.

Annex L: MIMO

L.1 OVERVIEW

MIMO (Multiple-Input Multiple-Output) improves robustness via additional spatial diversity and/or increases capacity by sending two data streams in a single RF channel (spatial multiplexing). The spatial multiplexing gain is achieved only in the case of MIMO, and allows overcoming the capacity limit of single antenna wireless communications in a given channel bandwidth. Note that, to obtain the increase in channel capacity that can be provided with use of MIMO, a higher total transmission power than in the single-antenna case will be required if the same service area and S/N threshold are to be maintained. For SIMO (Single-Input Multiple-Output) and MISO (Multiple-Input Single-Output) only spatial diversity gain is achieved. MIMO is an optional technology but when adopted shall conform to the requirements of this Annex.

In this version of the specification, MIMO processing is restricted to a 2×2 antenna system, with the two antennas orthogonally polarized with respect to one another. This means that at least two effective antennas, operating with different radiation Polarizations, and thereby creating independent propagation paths, must be present at both transmitter and receiver locations. In practice, cross-polarized MIMO antennas (e.g., having horizontally and vertically polarized elements or possibly having elements rotated 45 degrees in the same direction from horizontal and vertical) should be used. Transmitters should include individually fed cross-polar antennas, and receivers should include individually connected cross-polar pairs of antennas in order to receive and decode MIMO signals.

Figure L.1.1 depicts a MIMO transmission chain. Two new blocks can be identified, providing MIMO mapping and MIMO Precoding functions. The MIMO transmission chain re-uses as many blocks as possible from SISO, including FEC codes, bit interleavers, constellations, and frequency and time interleavers. Additional pilot patterns have been defined for MIMO such that the same echo tolerance/Doppler performance as for SISO is achieved. All blocks not specifically mentioned in this Annex, such as input formatting, guard interval, etc. shall follow their specifications for SISO.

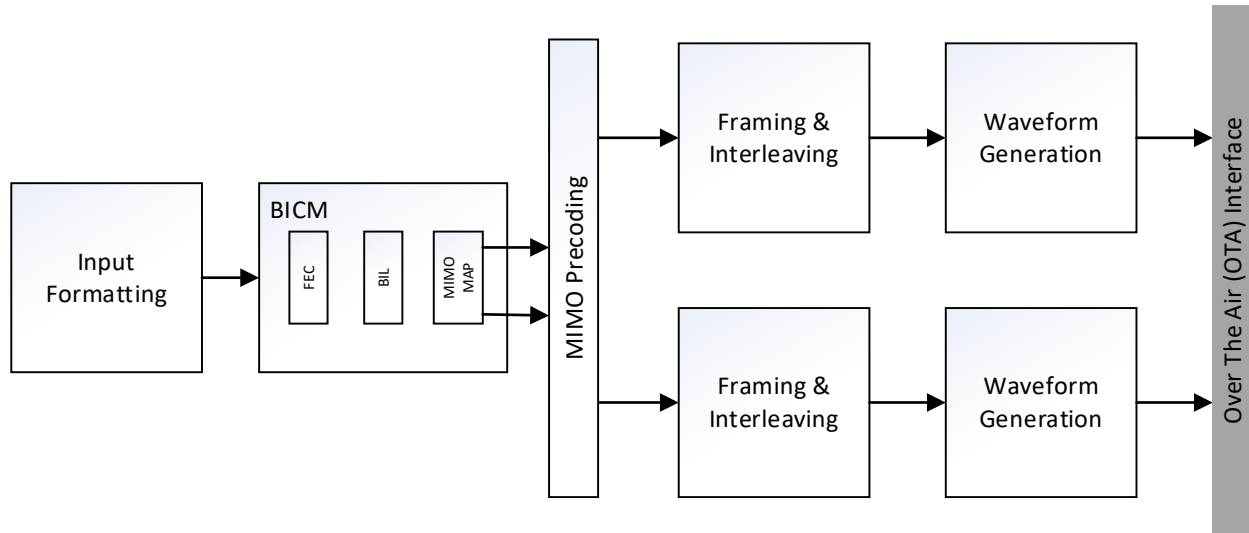

Figure L.1.1 MIMO block diagram.

The MIMO MAP function consists of a DeMultiplexer block followed by bit-to-IQ-mapping blocks. A block diagram of the MIMO MAP is shown in Figure L.1.2.

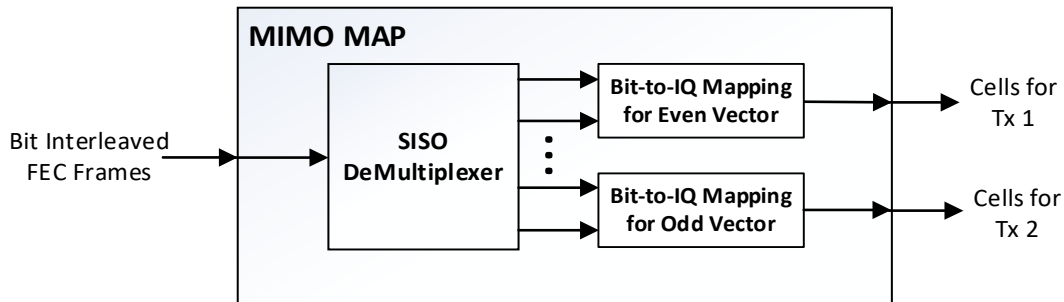

Figure L.1.2 MIMO MAP block diagram.

MIMO processing shall not be applied to Bootstraps or Preambles. MIMO processing shall be applied only to Subframes.

MIMO shall not be used with ACE, however the remaining features of the specification, including LDM and channel bonding, are compatible with MIMO. This Annex describes the specifications for MIMO not combined with LDM. The combination of MIMO and LDM is described in Annex O.

L.2 FEC CODING

The same FEC codes as in Section 6.1 shall be used for MIMO.

L.3 BIT INTERLEAVING

The same bit interleavers as in Section 6.2 shall be used for MIMO.

L.4 MIMO MAPPING

L.4.1 Demultiplexer

The MIMO demultiplexer is composed of two stages. The first stage is exactly the same as the SISO demultiplexing described in Section 6.3.3. The second stage alternately spreads the output vectors of the first stage SISO demultiplexer into two constellation mappers, one for each transmitting Polarization.

At the second stage, the even vector ($y_{0,2n}, \dots, y_{\eta MOD-1,2n}$) and the odd vector ($y_{0,2n+1}, \dots, y_{\eta MOD-1,2n+1}$) are input to the mappers of transmitting Polarizations #1 and #2 respectively, where n is the value for indexing each vector:

$$n = (0, 1, 2, \dots, N - 1), \quad N = \left\lfloor \frac{N_{cell}}{2} \right\rfloor$$

N_{cell} is the number of the output data cells for each FEC Frame input to the demultiplexer, as shown in Table 6.14.

L.4.2 Constellations

The same constellations as in Section 6.3 shall be used for MIMO. The same modulation order shall be transmitted in both Polarizations.

The combination of 256QAM and FEC codes with length $N_{inner}=16200$ bits shall not be allowed, since it does not yield an integer number of modulated cells per Polarization per FEC Block. All remaining ModCod combinations are feasible for MIMO.

For MIMO L1 signaling does not signal the modulation order as for SISO, but rather the bits per cell unit (bpcu), which defines the overall spectrum efficiency per cell for the two Polarizations, as shown in Table L.4.1.

Table L.4.1 Bits Per Cell Unit and Modulation for MIMO

Bits per Cell Unit (bpcu)	MIMO Modulation	
4	Tx1	QPSK
	Tx2	QPSK
8	Tx1	16QAM
	Tx2	16QAM
12	Tx1	64QAM
	Tx2	64QAM
16	Tx1	256QAM
	Tx2	256QAM
20	Tx1	1024QAM
	Tx2	1024QAM
24	Tx1	4096QAM
	Tx2	4096QAM

L.5 PRECODING

MIMO precoding acts on a pair of input constellation symbols (X_{2i}, X_{2i+1}), where i is the index of the cell pair within the FEC Block, and creates a pair of output constellation symbols as depicted in Figure L.5.1. Encoded cell pairs (S_{2i}, S_{2i+1}) shall be transmitted on the same OFDM symbol and

carrier from transmitting Polarization #1 (Tx1) and transmitting Polarization #2 (Tx2), respectively.

MIMO precoding is never applied to Bootstraps or Preambles, only to Subframes.

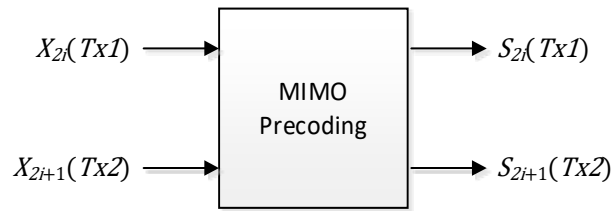

Figure L.5.1 Generic MIMO Precoding block diagram.

MIMO precoding is based on spatial multiplexing, and consists of three different steps, as depicted in Figure L.5.2:

- Stream combining
- IQ polarization interleaving
- Phase hopping

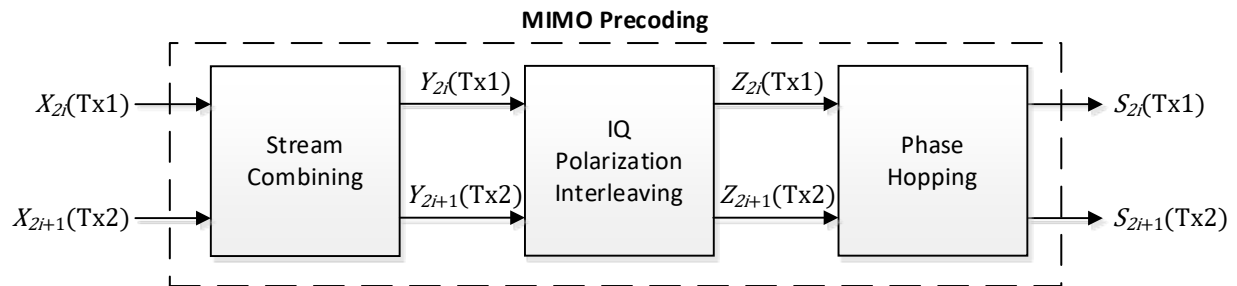

Figure L.5.2 Detailed MIMO precoding block diagram.

MIMO precoding shall be applied at the PLP level. Each of the three sub-blocks of MIMO precoding is optional. This allows for the possibility of configuring the precoder in a transparent way in the transmission chain, such that the output pair of cells is exactly the input pair of cells. This particular case is known as plain spatial multiplexing.

$$S_{2i}(Tx1) = Z_{2i}(Tx1) = Y_{2i}(Tx1) = X_{2i}(Tx1)$$

$$S_{2i+1}(Tx2) = Z_{2i+1}(Tx2) = Y_{2i+1}(Tx2) = X_{2i+1}(Tx2)$$

The next subsections describe the signal processing performed at each sub-block of the precoding when used. If not used, the output pair of cells shall be exactly the same as the input pair of cells.

L.5.1 Stream Combining

The stream combining consists of a combination of the pair of input constellation symbols based on a rotation matrix with angle θ . The value of the rotation angle is fixed and its value depends on the modulation and coding used in the PLP. The stream combining operation shall be mathematically expressed as follows:

$$\begin{bmatrix} Y_{2i}(\text{Tx1}) \\ Y_{2i+1}(\text{Tx2}) \end{bmatrix} = \begin{bmatrix} \cos \theta & \sin \theta \\ \sin \theta & -\cos \theta \end{bmatrix} \begin{bmatrix} X_{2i}(\text{Tx1}) \\ X_{2i+1}(\text{Tx2}) \end{bmatrix}$$

Table L.5.1 defines the value of the rotation angle θ for each modulation order and code rate.

Table L.5.1 Rotation Angle for the Stream Combining

MIMO Code Rate	MIMO Modulation Order					
	4bpcu (QPSK pairs)	8bpcu (16QAM pairs)	12bpcu (64QAM pairs)	16bpcu (256QAM pairs)	20bpcu (1kQAM pairs)	24bpcu (4kQAM pairs)
2/15	0°	0°	0°	0°	0°	0°
3/15	0°	0°	0°	0°	0°	0°
4/15	0°	0°	0°	0°	0°	0°
5/15	0°	0°	0°	0°	0°	0°
6/15	5°	0°	0°	0°	0°	0°
7/15	5°	0°	0°	0°	0°	0°
8/15	20°	0°	0°	0°	0°	0°
9/15	20°	0°	0°	0°	0°	0°
10/15	35°	0°	0°	0°	0°	0°
11/15	35°	5°	0°	0°	0°	0°
12/15	35°	5°	0°	0°	0°	0°
13/15	45°	5°	0°	0°	0°	0°

L.5.2 I/Q Polarization Interleaving

The I/Q Polarization interleaver is simply a switching interleaving operation, such that the output cells consist of the real (i.e., In-phase) component of one input symbol and the imaginary (i.e., Quadrature) component of the other input symbol. The I/Q polarization interleaving shall be described by the following equations:

$$Z_{2i}(\text{Tx1}) = \text{Re}\{Y_{2i}(\text{Tx1})\} + j \cdot \text{Im}\{Y_{2i+1}(\text{Tx2})\}$$

$$Z_{2i+1}(\text{Tx2}) = \text{Re}\{Y_{2i+1}(\text{Tx2})\} + j \cdot \text{Im}\{Y_{2i}(\text{Tx1})\}$$

L.5.3 Phase Hopping

The phase hopping consists of a phase rotation to the symbols of the second transmitting Polarization. The phase hopping operation shall be mathematically expressed as follows:

$$\begin{bmatrix} S_{2i}(\text{Tx1}) \\ S_{2i+1}(\text{Tx2}) \end{bmatrix} = \begin{bmatrix} 1 & 0 \\ 0 & e^{j\phi(i)} \end{bmatrix} \begin{bmatrix} Z_{2i}(\text{Tx1}) \\ Z_{2i+1}(\text{Tx2}) \end{bmatrix}$$

where ϕ is the phase rotation angle, defined by the following equation:

$$\phi(i) = \frac{2\pi}{N} i, (N = 9), i = 0, \dots, \frac{N_{\text{cells}}}{2} - 1$$

where N_{cells} is the number of cells per FEC Block. The phase rotation is initialized to 0 radians at the beginning of each FEC Block and is incremented by $2\pi/9$ radians for every cell pair.

L.6 TIME INTERLEAVER

The same time interleavers as in Section 7.1 shall be used for MIMO. Since the time interleaving is carried out after the generation of two MIMO streams there are two parallel time interleavers. The time interleaving applied to both MIMO streams shall be identical. The total memory requirement as described in Section 7.1.2 applies to each time interleaver for each Polarization. Hence, time interleaving for MIMO requires twice the memory as is required for SISO. When MIMO is used with channel bonding, the total memory requirement is proportional to the number of combined RF channels compared to the memory required for MIMO transmission within a single RF channel. In this version of the specification, the total memory requirement for MIMO with channel bonding is twice and four times that of MIMO and SISO transmissions within a single RF channel, respectively.

When SISO and MIMO PLPs assemble a complete delivered product, the total TI memory required for the complete delivered product shall be twice the amount specified in Section 7.1.2. Simultaneously, the group of PLPs comprising all SISO PLPs within this complete delivered product shall individually satisfy the TI memory constraint specified in Section 7.1.2.

Extended interleaving mode as defined in Section 7.1.3 may be optionally enabled. Extended interleaving shall only be used when the modulation is QPSK and MIMO precoding is disabled (`L1D_plp_mimo_stream_combining == 0` and `L1D_plp_mimo_IQ_interleaving == 0` and `L1D_plp_mimo_PH == 0`).

L.7 FRAMER

MIMO Frames shall be built according to Section 7.2.

The specific multiplexing techniques allowed for MIMO shall be the following:

- Time division multiplexing (TDM), as described in Section 7.2.7.3.
- Frequency division multiplexing (FDM), as described in Section 7.2.7.5.
- Time and frequency division multiplexing (TFDM), as described in Section 7.2.7.6.

The number of available data cells for cell multiplexing can be obtained from tables in Section 7.2.6. Equivalent SISO pilot patterns that have the same number and position as those of MIMO scattered pilot patterns shall be used for a table lookup. Equivalent SISO scattered pilot patterns are shown in Table L.9.2.

Data cell indexing described in Section 7.2.6.1 is applied individually to Polarizations #1 and #2. Initialization of data cells accordingly proceeds independently for each Polarization. For available data cells in a MIMO subframe, dummy modulation values shall be generated in parallel for each Polarization, following the same process defined in Section 7.2.6.5. Each Polarization shall initialize its available data cells with those generated dummy modulation values before overwriting them with actual PLP data. With parallel data cell indexing, an identical sequence of dummy modulation values shall be independently allocated to each Polarization.

MIMO PLP data cells shall not be allocated to any cells in Preamble symbol(s), even if there are available cells remaining in the last Preamble symbol. SISO PLP data cells may be allocated to any remaining cells in the last Preamble symbol.

This version of the specification specifies the multiplexing between MIMO and SISO PLPs as follows: TDM between MIMO and SISO PLPs is allowed on a subframe basis, but not within a single subframe; LDM of MIMO and SISO PLPs is allowed as described in Annex O.

L.8 FREQUENCY INTERLEAVING

The same frequency interleaver as in Section 7.3 shall be used for MIMO.

L.9 PILOT PATTERNS

L.9.1 Pilot Polarization Encoding

MIMO pilots fall on exactly the same positions as for SISO, but the amplitudes and/or phases of the scattered, continual, edge, and Subframe boundary pilots may be modified compared to SISO. Two MIMO pilot Polarization encoding algorithms are defined, namely:

- Walsh-Hadamard encoding.
- Null pilot encoding.

Only one MIMO pilot encoding algorithm shall be configured for a given Frame.

Table L.9.1 gives an overview of the different types of pilots and the corresponding MIMO pilot encoding mechanism per Polarization, where SISO indicates that the pilots are not modified compared to SISO, WH indicates Walsh-Hadamard encoding and NP indicates null pilot encoding. Both Polarizations shall transmit in all pilot positions, although the amplitudes of some transmitted pilots for null pilot encoding will be zero.

Note: Those cells which would be both an additional continual pilot and a scattered pilot shall be treated as scattered pilots, and they shall be encoded using Walsh-Hadamard encoding (for Polarization #2) or using null pilot encoding (for both Polarizations) depending upon the configured MIMO pilot encoding algorithm. The additional continual pilots that do not fall on scattered-pilot-bearing cells shall be treated similarly to common continual pilots and shall not be modified compared to SISO.

Table L.9.1 MIMO Pilot Polarization Encoding Overview

Pilot Encoding Algorithm	Polarization	Scattered Pilot	Subframe Boundary Pilot	Common Continual Pilot	Additional Continual Pilot	Edge Pilot
Walsh-Hadamard	#1	SISO	SISO	SISO	SISO	SISO
	#2	WH	WH	SISO	SISO/WH	WH
Null Pilot	#1	NP	SISO	SISO	SISO/NP	SISO
	#2	NP	WH	SISO	SISO/NP	WH

MIMO pilots are divided into two groups, namely group 1 and group 2, depending on the pilot encoding scheme used, as described in Section L.9.2. Both pilot groups are transmitted in each Polarization. However, each pilot encoding algorithm applies a specific signal processing method to each pilot group for each Polarization.

L.9.1.1. Walsh-Hadamard

With Walsh-Hadamard encoding, the phases of the scattered, additional continual, edge, and Subframe boundary pilots for group 2 are inverted in the signal transmitted in Polarization #2. The phases of both the group 1 and group 2 pilots transmitted in Polarization #1 and of the group 1 pilots transmitted in Polarization #2 shall not be modified.

The scattered pilots transmitted in Polarization #2 shall be inverted compared to Polarization #1 on alternate scattered pilot bearing carriers. These inverted scattered pilots represent the group

2 scattered pilots for Polarization #2. Both group 1 and group 2 scattered pilots for Polarization #2 shall be calculated using the following equations:

$$\operatorname{Re}\{c_{m,l,k}\} = 2 \cdot (-1)^{\frac{k}{D_X}} \cdot A_{\text{SP}} \cdot \left(\frac{1}{2} - r_k\right)$$

$$\operatorname{Im}\{c_{m,l,k}\} = 0$$

Common continual pilots and additional continual pilots on non-scattered-pilot-bearing cells shall not be inverted for either transmit Polarization. The few additional continual pilots which fall on scattered-pilot-bearing cells for which the scattered pilot transmitted in Polarization #2 would be inverted shall be inverted. Both group 1 and group 2 additional continual pilots for Polarization #2 shall be calculated using the following equations:

$$\operatorname{Re}\{c_{m,l,k}\} = 2 \cdot (-1)^{\frac{k}{D_X}} \cdot A_{\text{SP}} \cdot \left(\frac{1}{2} - r_k\right) \quad \text{for } k \bmod D_X = 0$$

$$\operatorname{Re}\{c_{m,l,k}\} = 2 \cdot A_{\text{SP}} \cdot \left(\frac{1}{2} - r_k\right) \quad \text{otherwise}$$

$$\operatorname{Im}\{c_{m,l,k}\} = 0$$

Note: Those cells which would be both an additional continual pilot and a scattered pilot are treated as scattered pilots as described above. All additional continual pilots shall have the amplitude A_{SP} as in SISO.

The edge pilots in Polarization #2 shall be inverted compared to Polarization #1 on odd numbered OFDM symbols. Both group 1 and group 2 edge pilots in Polarization #2 shall be calculated using the following equations:

$$\operatorname{Re}\{c_{m,l,k}\} = 2 \cdot (-1)^l \cdot A_{\text{SP}} \cdot \left(\frac{1}{2} - r_k\right)$$

$$\operatorname{Im}\{c_{m,l,k}\} = 0$$

The Subframe boundary pilots in Polarization #2 shall be inverted compared to Polarization #1 on alternate scattered pilot bearing carriers. Both group 1 and group 2 Subframe boundary pilots in Polarization #2 shall be calculated using the following equations:

$$\operatorname{Re}\{c_{m,l,k}\} = 2 \cdot (-1)^{\frac{k}{D_X}} \cdot A_{\text{SP}} \cdot \left(\frac{1}{2} - r_k\right)$$

$$\operatorname{Im}\{c_{m,l,k}\} = 0$$

L.9.1.2. Null Pilot

With null pilot encoding, the amplitudes of the scattered pilots of both group 1 and group 2 are modified in the signals transmitted in Polarizations #1 and #2. With null pilot encoding, Polarization #1 shall transmit group 1 scattered pilots with 3 dB increased transmit power (amplitude of $\sqrt{2}A_{\text{SP}}$) and group 2 scattered pilots with null power (zero amplitude). Similarly,

Polarization #2 shall transmit group 2 scattered pilots with 3 dB increased transmit power (amplitude of $\sqrt{2}A_{SP}$) and group 1 scattered pilots with null power (zero amplitude).

Both group 1 and group 2 scattered pilots in Polarization #1 shall be calculated using the following equations:

$$\text{Re}\{c_{m,l,k}\} = \sqrt{2} \cdot \left(1 + (-1)^{\frac{k}{D_X D_Y} + \frac{(D_Y-1)l}{D_Y}} \right) \cdot A_{SP} \cdot \left(\frac{1}{2} - r_k \right)$$

$$\text{Im}\{c_{m,l,k}\} = 0$$

The scattered pilots transmitted in Polarization #2 shall be as given in the following equations:

$$\text{Re}\{c_{m,l,k}\} = \sqrt{2} \cdot \left(1 + (-1)^{\frac{k}{D_X D_Y} + \frac{(D_Y-1)l}{D_Y} + 1} \right) \cdot A_{SP} \cdot \left(\frac{1}{2} - r_k \right)$$

$$\text{Im}\{c_{m,l,k}\} = 0$$

Common continual pilots and additional continual pilots on non-scattered-pilot-bearing cells shall not be modified compared to SISO for either transmit Polarization. The few additional continual pilots falling on scattered-pilot-bearing carriers shall be encoded using the null pilot encoding for scattered pilots.

Note: Those cells which would be both an additional continual pilot and a scattered pilot shall be treated as scattered pilots and therefore shall have the amplitude $\sqrt{2}A_{SP}$ or 0. The additional continual pilot cells which do not fall on scattered pilot positions shall have the amplitude A_{SP} as in SISO.

With null pilot encoding, the edge pilots and Subframe boundary pilots shall be encoded using Walsh-Hadamard encoding. The phases of the group 2 edge and Subframe boundary pilots shall be inverted in the signal transmitted in Polarization #2 using Walsh-Hadamard encoding as described in the previous section.

L.9.2 Pilot Schemes

This section illustrates the scattered pilot patterns for MIMO following the same model used for the SISO scattered pilot patterns in Annex E.

Twelve MIMO scattered pilot patterns are defined for Walsh-Hadamard pilot encoding and are illustrated from Figure L.9.1 to Figure L.9.12. Sixteen MIMO scattered pilot patterns are defined for null pilot encoding and are illustrated from Figure L.9.13 to Figure L.9.28.

The terminology employed for the MIMO pilot patterns is $MP_{\mathbf{a}}_{\mathbf{b}}$, where $\mathbf{a} = D_X$ and $\mathbf{b} = D_Y$ are defined taking into account the two transmit Polarizations, such that each MIMO pilot pattern has pilots in exactly the same positions as the equivalent SISO pilot pattern.

Table L.9.2 lists each MIMO pilot scheme, the corresponding equivalent SISO pilot scheme, and the values of D_X and D_Y . Note that the equivalent values of D_X and D_Y per transmit Polarization for the two available MIMO pilot encoding schemes are not shown in the table. The last four rows of the table are only allowed for null pilot encoding.

Table L.9.2 MIMO Pilot Schemes with Equivalent SISO Pilot Schemes and D_X and D_Y Values

MIMO Pilot Scheme	Equivalent SISO Pilot Scheme	D_X	D_Y
MP3_2	SP3_2	3	2
MP3_4	SP3_4	3	4
MP4_2	SP4_2	4	2
MP4_4	SP4_4	4	4
MP6_2	SP6_2	6	2
MP6_4	SP6_4	6	4
MP8_2	SP8_2	8	2
MP8_4	SP8_4	8	4
MP12_2	SP12_2	12	2
MP12_4	SP12_4	12	4
MP16_2	SP16_2	16	2
MP16_4	SP16_4	16	4
MP24_2	SP24_2	24	2
MP24_4	SP24_4	24	4
MP32_2	SP32_2	32	2
MP32_4	SP32_4	32	4

Similar restrictions for the MIMO pilot schemes in terms of the FFT size and the GI length apply as for SISO, as described in Table 8.3. The allowed FFT size and GI length combinations with Walsh-Hadamard encoding shall be as defined in Table L.9.3. The allowed FFT size and GI length combinations with null pilot encoding shall be as defined in Table L.9.4. *N/A* indicates a combination of FFT size and GI length that has no valid scattered pilot pattern.

Table L.9.3 Allowed Scattered Pilot Patterns for Each Allowed Combination of FFT Size and Guard Interval Length in MIMO Mode with Walsh-Hadamard Encoding

GI Pattern	Samples	8K FFT	16K FFT	32K FFT
GI1_192	192	MP16_2, MP16_4, MP8_2, MP8_4	MP16_2, MP16_4	MP16_2
GI2_384	384	MP8_2, MP8_4, MP4_2, MP4_4	MP16_2, MP16_4, MP8_2, MP8_4	MP16_2
GI3_512	512	MP6_2, MP6_4, MP3_2, MP3_4	MP12_2, MP12_4, MP6_2, MP6_4	MP12_2
GI4_768	768	MP4_2, MP4_4	M8_2, M8_4, MP4_2, MP4_4	MP16_2, MP8_2
GI5_1024	1024	MP3_2, MP3_4	MP6_2, MP6_4, MP3_2, MP3_4	MP12_2, MP6_2
GI6_1536	1536	N/A	MP4_2, MP4_4	MP8_2
GI7_2048	2048	N/A	MP3_2, MP3_4	MP6_2, MP3_2
GI8_2432	2432	N/A	MP3_2, MP3_4	MP6_2, MP3_2
GI9_3072	3072	N/A	N/A	MP3_2
GI10_3648	3648	N/A	N/A	MP3_2
GI11_4096	4096	N/A	N/A	MP3_2
GI12_4864	4864	N/A	N/A	MP3_2

Table L.9.4 Allowed Scattered Pilot Patterns for Each Allowed Combination of FFT Size and Guard Interval Length in MIMO Mode with Null Pilot Encoding

GI Pattern	Samples	8K FFT	16K FFT	32K FFT
GI1_192	192	MP32_2, MP32_4, MP16_2, MP16_4	MP32_2, MP32_4	MP32_2
GI2_384	384	MP16_2, MP16_4, MP8_2, MP8_4	MP32_2, MP32_4, MP16_2, MP16_4	MP32_2
GI3_512	512	MP12_2, MP12_4, MP6_2, MP6_4	MP24_2, MP24_4, MP12_2, MP12_4	MP24_2
GI4_768	768	MP8_2, MP8_4, MP4_2, MP4_4	M16_2, M16_4, MP8_2, MP8_4	MP32_2, MP16_2
GI5_1024	1024	MP6_2, MP6_4, MP3_2, MP3_4	MP12_2, MP12_4, MP6_2, MP6_4	MP24_2, MP12_2
GI6_1536	1536	MP4_2, MP4_4	MP8_2, MP8_4, MP4_2, MP4_4	MP16_2, MP8_2
GI7_2048	2048	MP3_2, MP3_4	MP6_2, MP6_4, MP3_2, MP3_4	MP12_2, MP6_2
GI8_2432	2432	N/A	MP6_2, MP6_4, MP3_2, MP3_4	MP12_2, MP6_2
GI9_3072	3072	N/A	MP4_2, MP4_4	MP8_2, MP3_2
GI10_3648	3648	N/A	MP4_2, MP4_4	MP8_2, MP3_2
GI11_4096	4096	N/A	MP3_2, MP3_4	MP6_2, MP3_2
GI12_4864	4864	N/A	N/A	MP6_2, MP3_2

L.9.2.1. Walsh-Hadamard

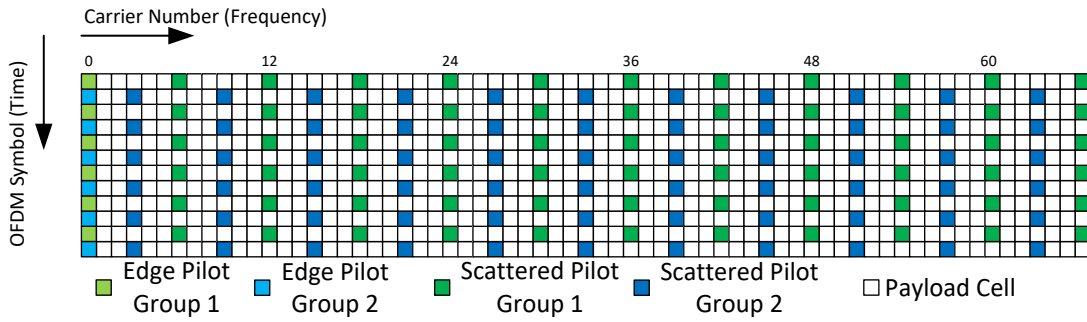

Figure L.9.1 MIMO pilot scheme MP3_2 for Walsh-Hadamard pilot encoding.

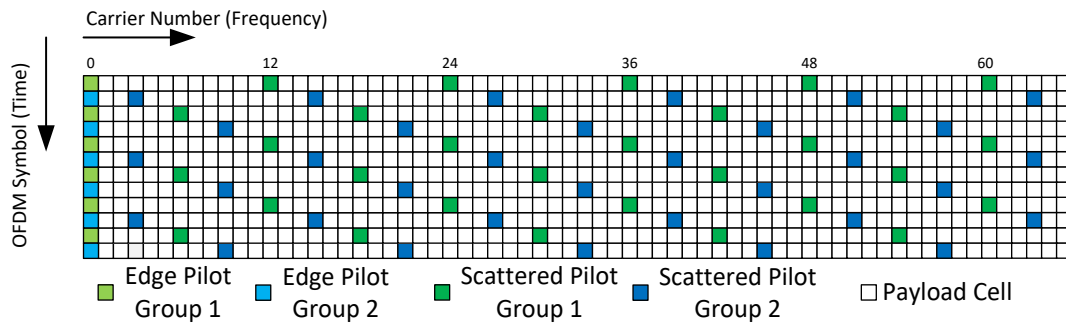

Figure L.9.2 MIMO pilot scheme MP3_4 for Walsh-Hadamard pilot encoding.

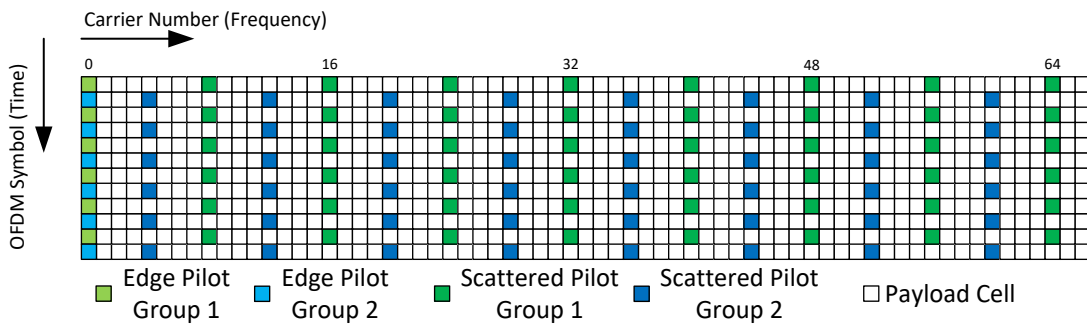

Figure L.9.3 MIMO pilot scheme MP4_2 for Walsh-Hadamard pilot encoding.

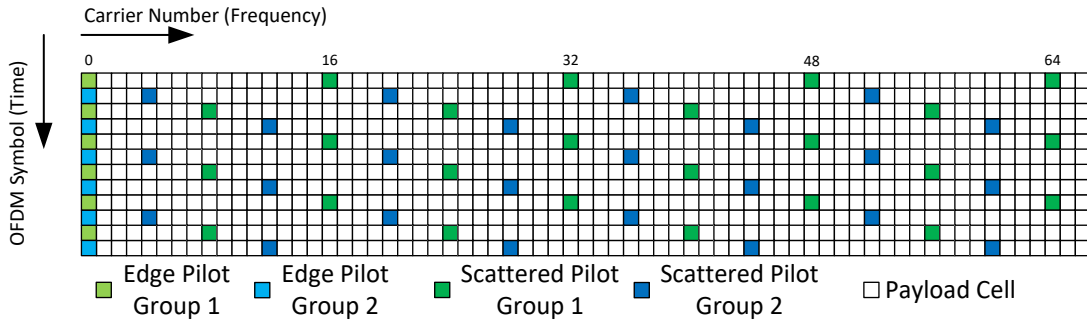

Figure L.9.4 MIMO pilot scheme MP4_4 for Walsh-Hadamard pilot encoding.

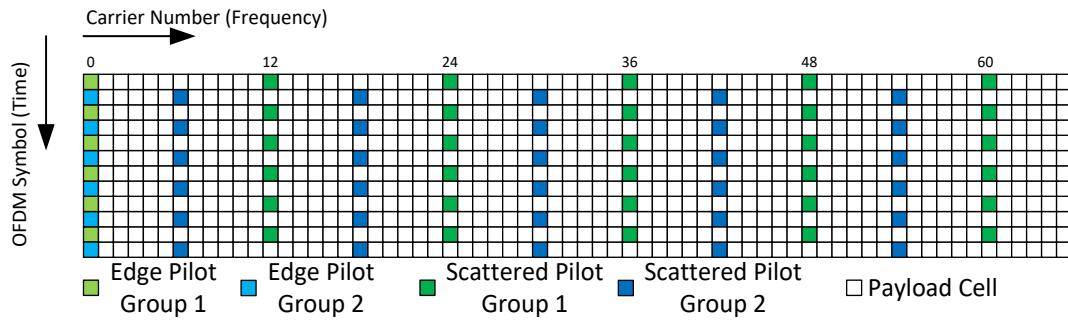

Figure L.9.5 MIMO pilot scheme MP6_2 for Walsh-Hadamard pilot encoding.

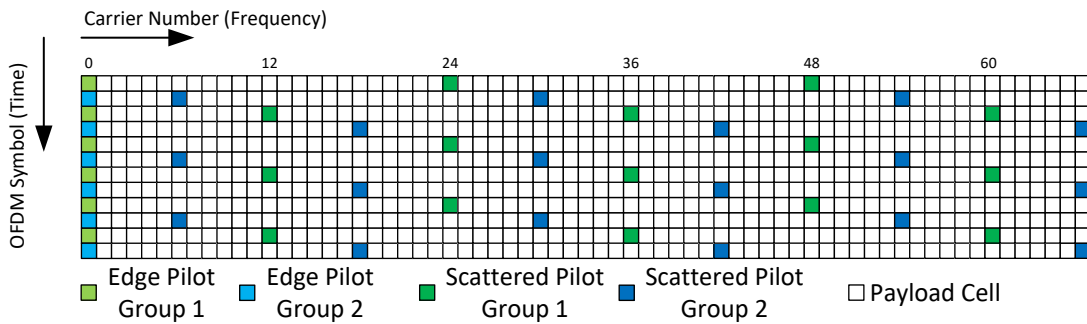

Figure L.9.6 MIMO pilot scheme MP6_4 for Walsh-Hadamard pilot encoding.

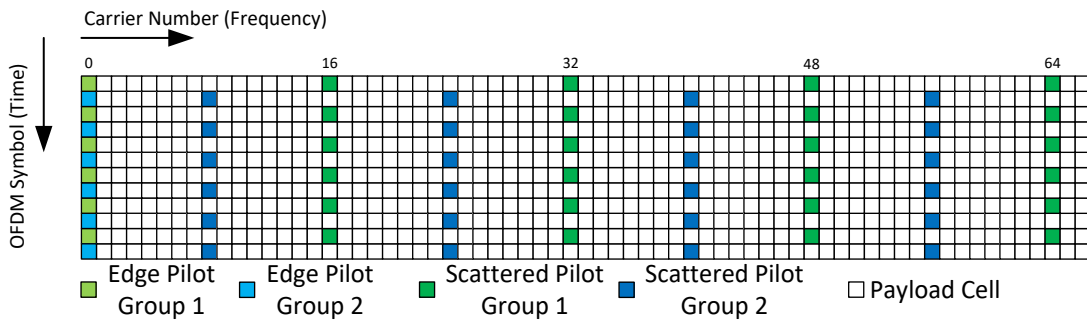

Figure L.9.7 MIMO pilot scheme MP8_2 for Walsh-Hadamard pilot encoding.

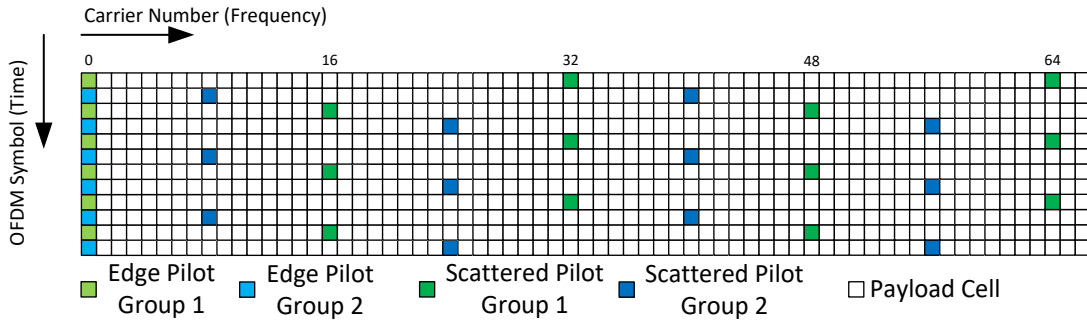

Figure L.9.8 MIMO pilot scheme MP8_4 for Walsh-Hadamard pilot encoding.

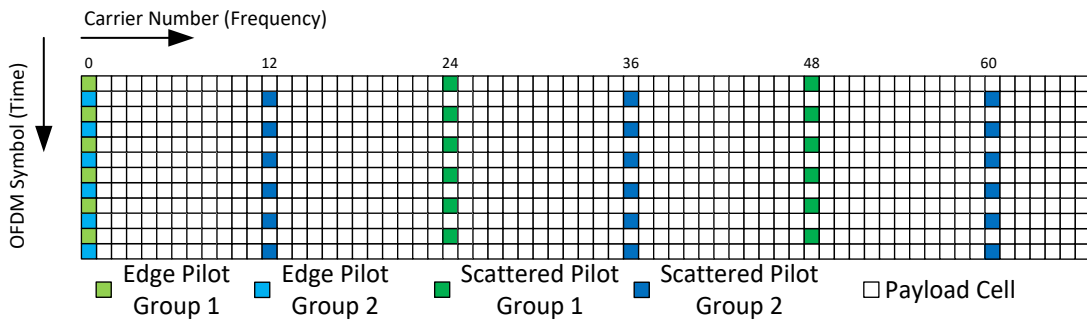

Figure L.9.9 MIMO pilot scheme MP12_2 for Walsh-Hadamard pilot encoding.

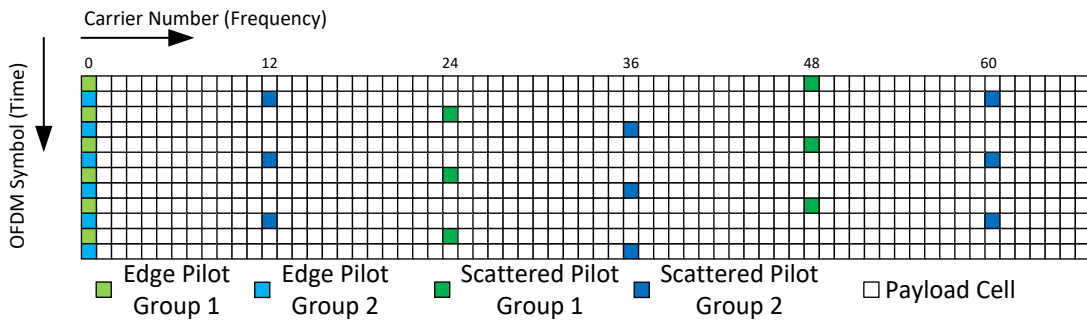

Figure L.9.10 MIMO pilot scheme MP12_4 for Walsh-Hadamard pilot encoding.

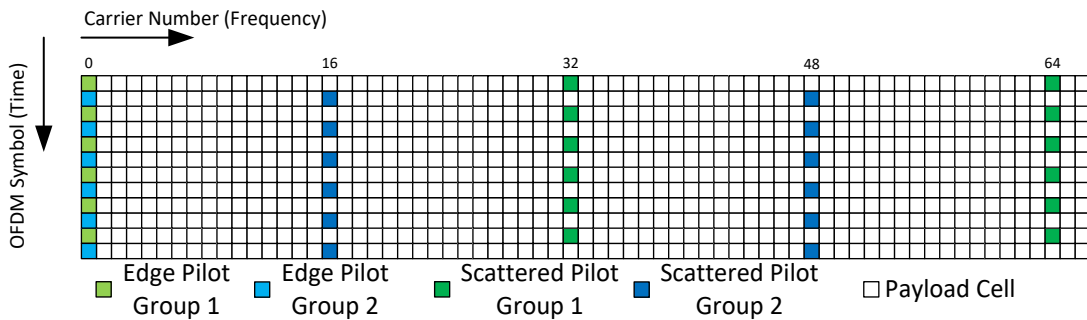

Figure L.9.11 MIMO pilot scheme MP16_2 for Walsh-Hadamard pilot encoding.

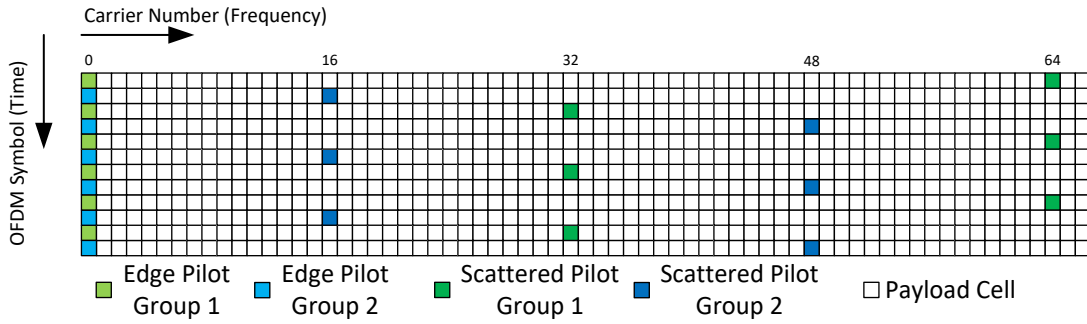

Figure L.9.12 MIMO pilot scheme MP16_4 for Walsh-Hadamard pilot encoding.

L.9.2.2. Null Pilots

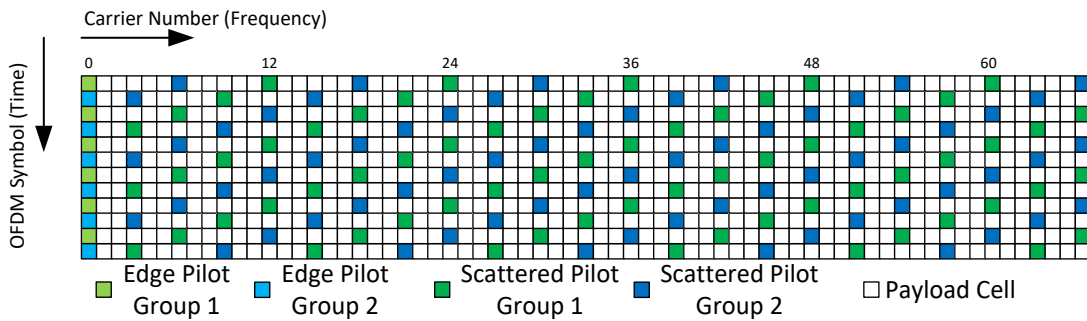

Figure L.9.13 MIMO pilot scheme MP3_2 for null pilot encoding.

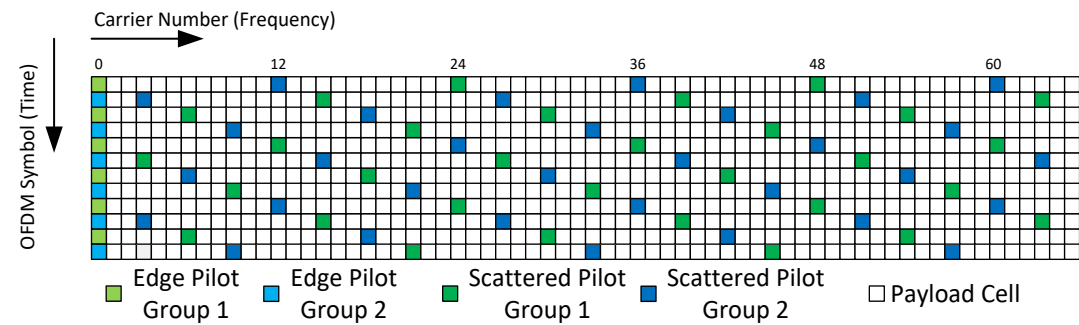

Figure L.9.14 MIMO pilot scheme MP3_4 for null pilot encoding.

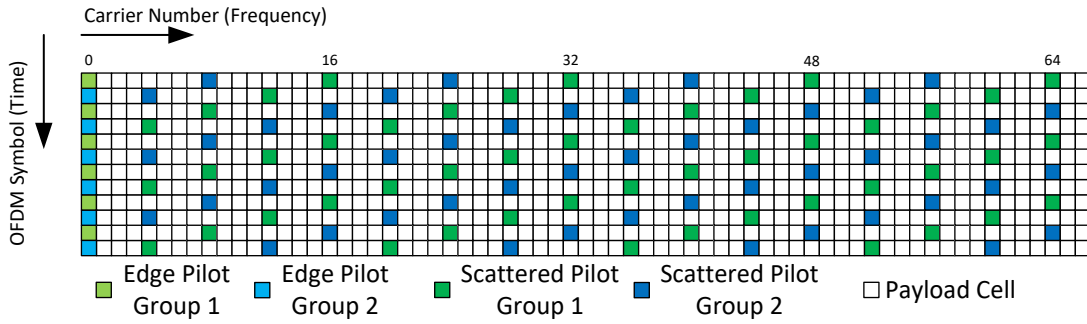

Figure L.9.15 MIMO pilot scheme MP4_2 for null pilot encoding.

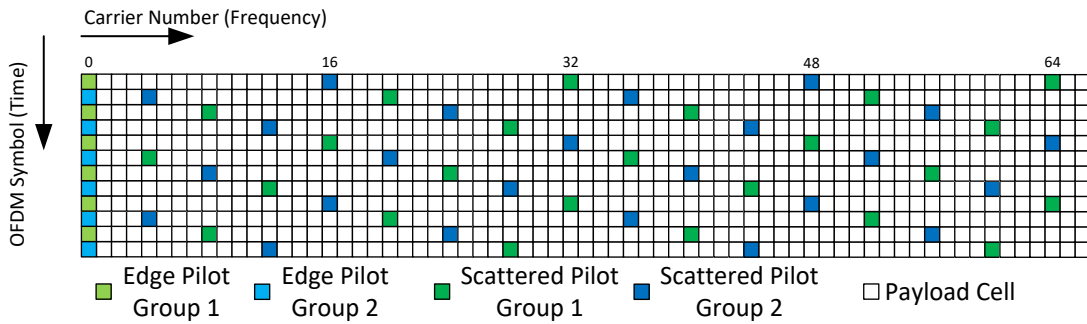

Figure L.9.16 MIMO pilot scheme MP4_4 for null pilot encoding.

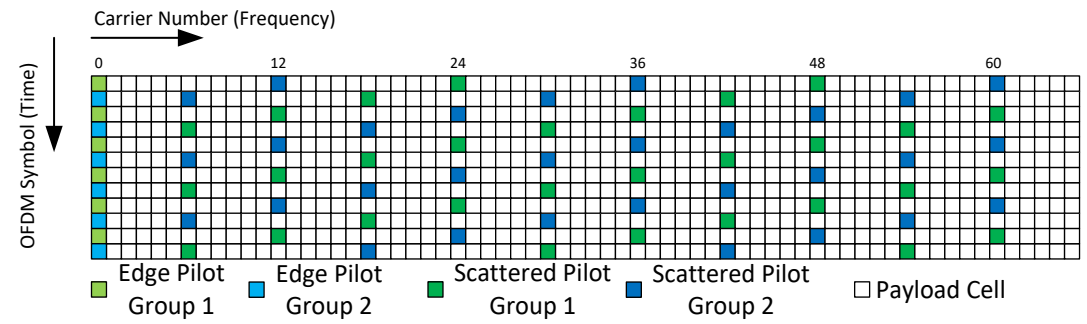

Figure L.9.17 MIMO pilot scheme MP6_2 for null pilot encoding.

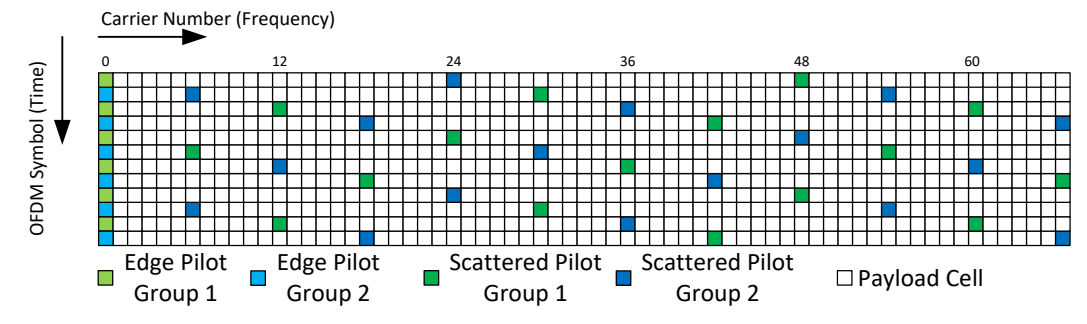

Figure L.9.18 MIMO pilot scheme MP6_4 for null pilot encoding.

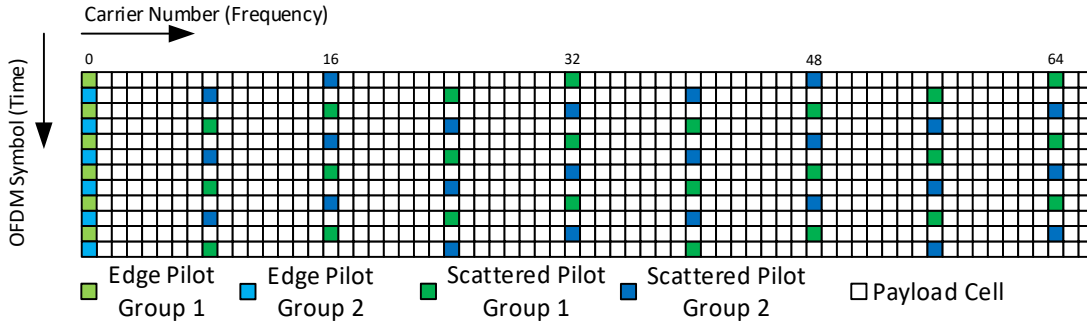

Figure L.9.19 MIMO pilot scheme MP8_2 for null pilot encoding.

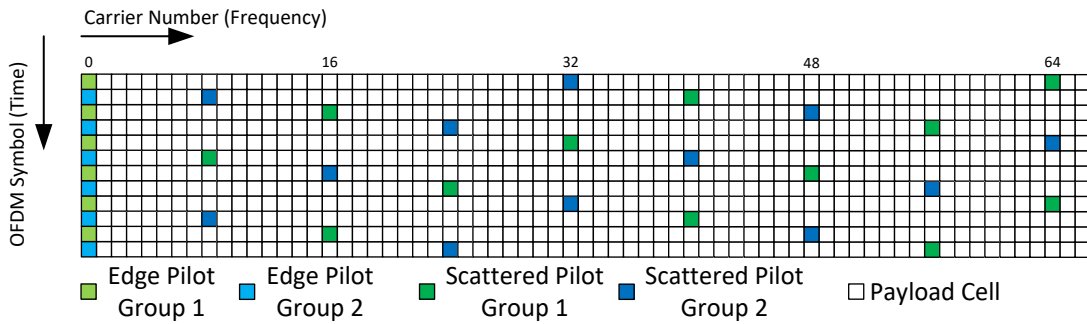

Figure L.9.20 MIMO pilot scheme MP8_4 for null pilot encoding.

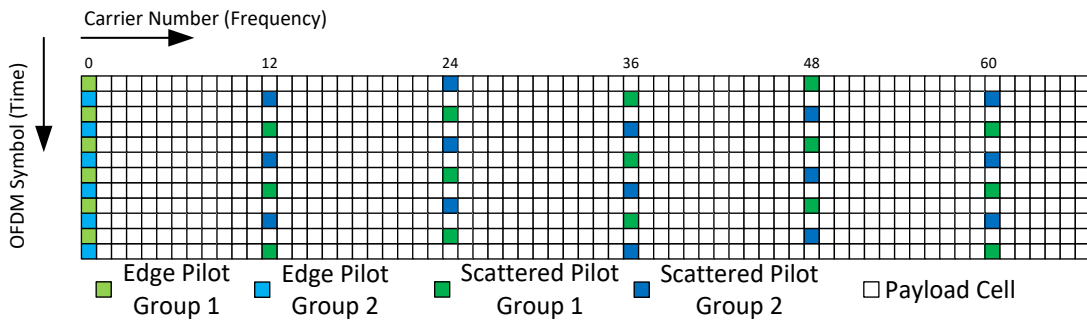

Figure L.9.21 MIMO pilot scheme MP12_2 for null pilot encoding.

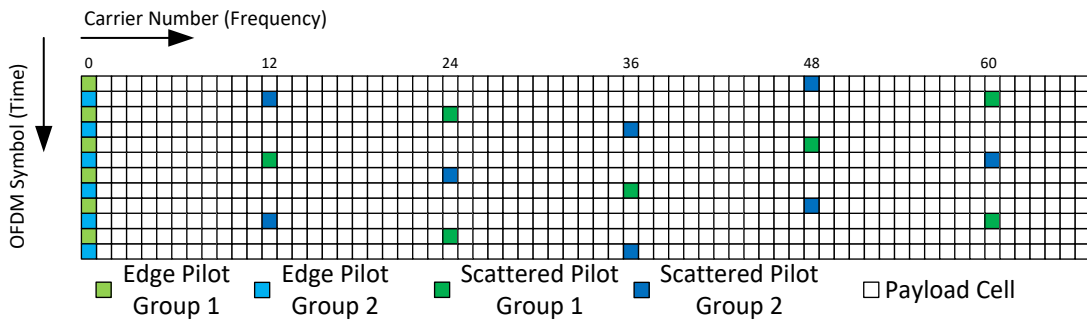

Figure L.9.22 MIMO pilot scheme MP12_4 for null pilot encoding.

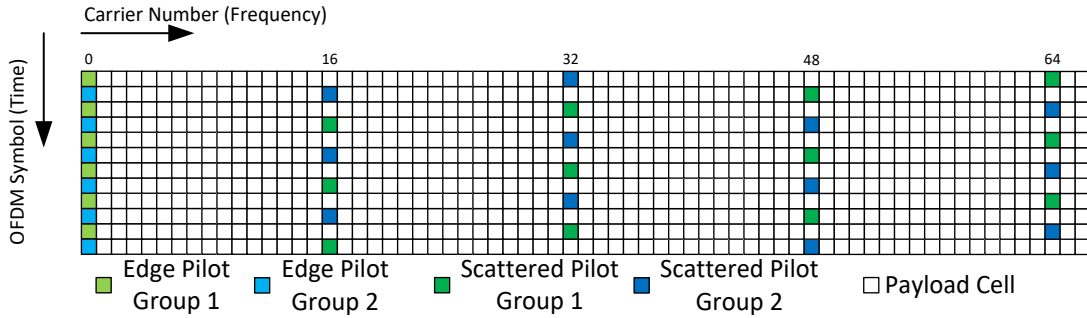

Figure L.9.23 MIMO pilot scheme MP16_2 for null pilot encoding.

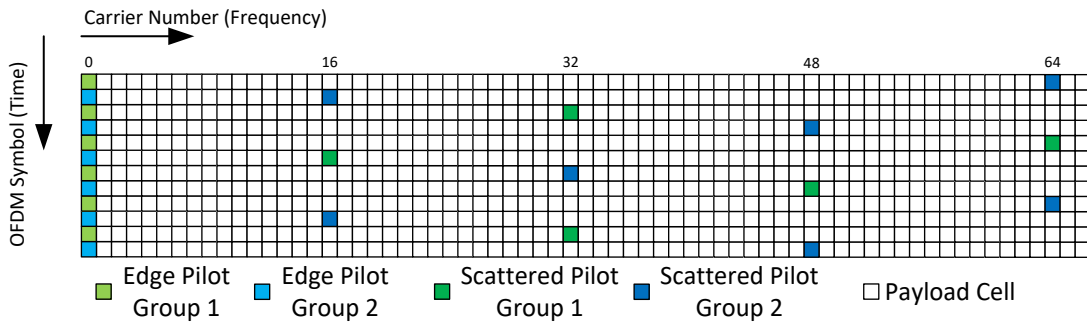

Figure L.9.24 MIMO pilot scheme MP16_4 for null pilot encoding.

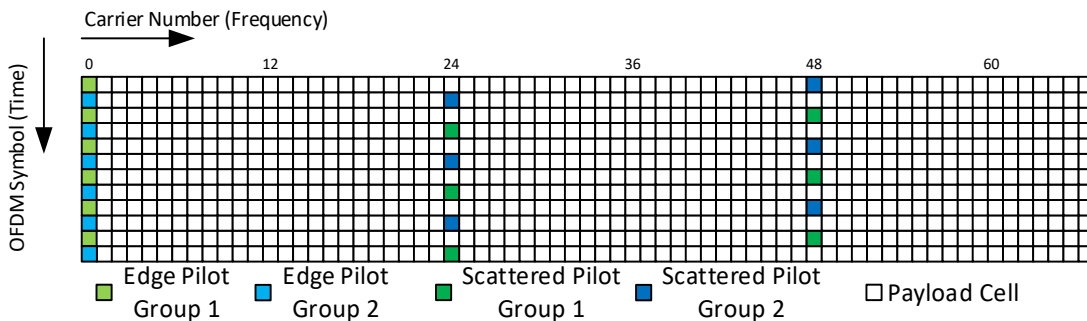

Figure L.9.25 MIMO pilot scheme MP24_2 for null pilot encoding.

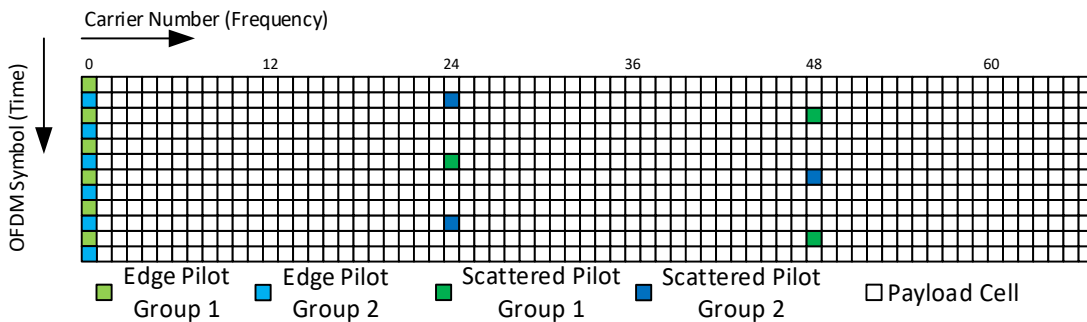

Figure L.9.26 MIMO pilot scheme MP24_4 for null pilot encoding.

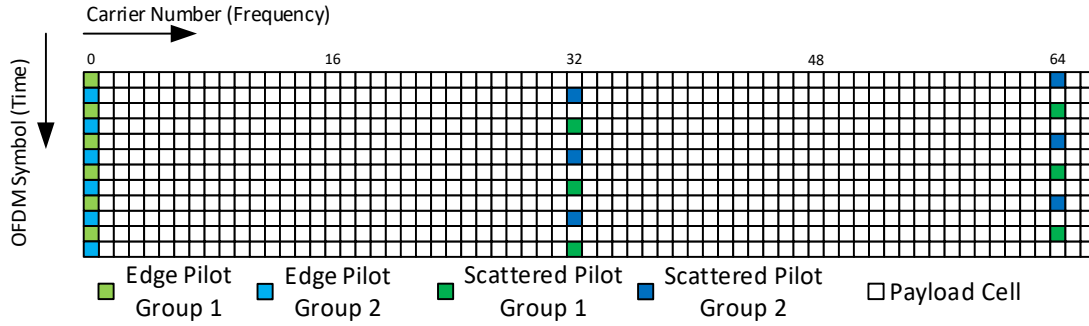

Figure L.9.27 MIMO pilot scheme MP32_2 for null pilot encoding.

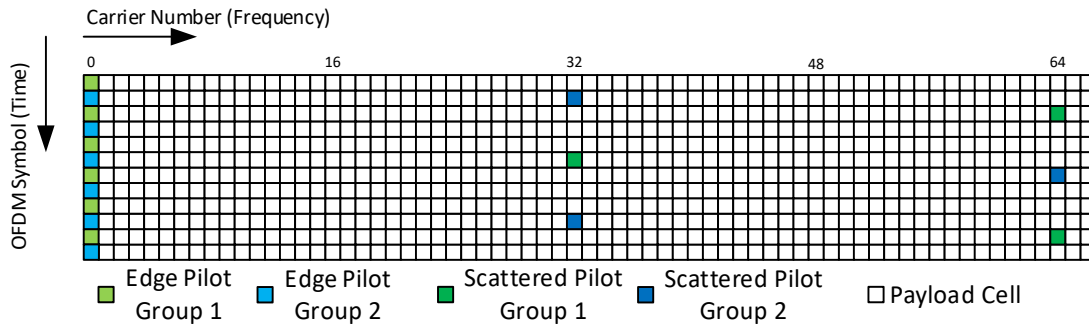

Figure L.9.28 MIMO pilot scheme MP32_4 for null pilot encoding.

L.10 MISO

The use of MISO, as described in Section 8.2 may be optionally added to MIMO with a unique MISO code applied per station or per Polarization.

L.11 IFFT

The same OFDM structures as in Section 8.3 shall be used for each Polarization stream in MIMO transmission.

IFFT for MIMO follows the definitions and descriptions in Section 8.3 but includes a partial augmentation. Since MIMO introduces an extra transmission path in addition to a SISO setup, the waveform expression for MIMO shall render the following two framing scenarios explainable:

- Case 1: Pure MIMO Frame consisting solely of MIMO Subframe(s)
- Case 2: Coexistence of MIMO and SISO Subframes based on TDM

If MIMO is in use, the baseband time domain signal after IFFT shall be described in a Polarization-specific fashion as follows:

$$\sum_{l=0}^{L_{FP}-1} \frac{1}{\sqrt{P_{preamble,l}}} \sum_{k=0}^{NoC_{P,l}-1} c_{l,k} \times \psi_{l,k}(t) + \sum_{\substack{m=0, \\ m \in S_{M,a}}}^{N_{SF}-1} \frac{1}{\sqrt{P_{data,m}}} \sum_{l=0}^{L_{SFm}-1} \sum_{k=0}^{NoC_m-1} c_{a,m,l,k} \times \psi_{m,l,k}(t)$$

where $\psi_{l,k}(t)$ and $\psi_{m,l,k}(t)$ shall follow the same definitions as in Section 8.3 and:

a	denotes the Polarization index, where $a = 0$ and $a = 1$ indicates Polarizations #1 and #2, respectively;
k	denotes the carrier number;
l	denotes the OFDM symbol number starting from 0 for the first Preamble symbol of a Frame and being reset at the first OFDM symbol of each Subframe;
m	denotes the Subframe number, $0 \leq m < N_{SF}$;
$c_{l,k}$	is the complex modulation value for carrier k of the Preamble symbol number l ;
$c_{a,m,l,k}$	is the complex modulation value for carrier k of the OFDM symbol number l in Subframe number m associated with Polarization a ;
$S_{M,a}$	denotes the set of Subframe numbers, for which Polarization a is active during the transmission of those Subframes;
$NoC_{P,l}$	denotes the number of carriers in the $(l + 1)^{\text{th}}$ Preamble symbol. The first Preamble symbol ($l = 0$) always has the minimum NoC and the following Preamble symbols ($0 < l < L_{FP}$) share the same NoC value that is signaled in L1-Basic as explained in Sections 7.2.5.1 and 9.2.2;
NoC_m	denotes the number of carriers of Subframe m as defined in Table 8.8;
L_{SFm}	is the number of data and Subframe boundary symbols in Subframe m ;
L_{FP}	is the number of OFDM symbols in the Preamble;
N_{SF}	is the number of Subframes in a Frame;
$P_{\text{preamble},l}$	is the per-Polarization frequency domain total power of $(l + 1)^{\text{th}}$ Preamble symbol summarized in Table I.1.1;
$P_{\text{data},m}$	is the per-Polarization frequency domain total power of each data and Subframe boundary symbol in Subframe m . Allowed values of $P_{\text{data},m}$ are summarized in Table I.2.1 to Table I.2.5.

The MIMO transmitter shall transmit the same Preamble symbols over Polarizations #1 and #2. The presented signal expression shares a common value $c_{l,k}$ irrespective of the Polarization index a . Carrier signals in data and Subframe boundary symbols can differ between Polarization, and hence the corresponding carrier modulation value $c_{a,m,l,k}$ is defined as Polarization-specific.

IFFT power normalization for MIMO shall be applied to each Polarization stream. For the use of MIMO, the definitions of $P_{\text{preamble},l}$ and $P_{\text{data},m}$ are specified to be the frequency domain total power per Polarization. Evaluation of $P_{\text{preamble},l}$ and $P_{\text{data},m}$ for MIMO applies the same with the SISO processing. The same lookup tables as in Table I.1.1 and Table I.2.1 to Table I.2.5 shall be used for $P_{\text{preamble},l}$ and $P_{\text{data},m}$, respectively.

The presented MIMO-version post-IFFT signal expression is compatible with the framing scenarios of Case 1 and 2, where the Subframe indicator set $S_{M,a}$ shall vary depending thereon. The corresponding specifications related to each framing scenario are defined below.

L.11.1 Case 1: Pure MIMO Frame

If every Subframe in the Frame of interest uses MIMO, $S_{M,a}$ shall satisfy the following condition: $S_{M,a}$ shall consist of every integer within the range $0 \leq m < N_{SF}$, regardless of the value of a . That is, $S_{M,a} = \{0, \dots, N_{SF} - 1\}$.

L.11.2 Case 2: Coexistence with SISO Subframes

TDM of MIMO and SISO Subframes involves transmission of SISO signals at MIMO transmitters. In the current version of the specification, transmission of SISO signals from MIMO transmitters can take one of the following forms:

- Option 1: Polarization #1 transmits SISO Subframes and Polarization #2 is inactive during those Subframes.
- Option 2: Polarizations #1 and #2 transmit the same signal copies of SISO Subframes.

If Option 1 is applied, $S_{M,a}$ shall be defined accordingly as follows:

$S_{M,a}$ If $a = 0$, $S_{M,a} = \{0, \dots, N_{SF} - 1\}$. If $a = 1$, $S_{M,a}$ consists of the Subframe numbers that use MIMO.

For example, if Subframe 2 and Subframe 3 apply MIMO processing out of total $N_{SF} = 4$ Subframes, $S_{M,1}$ equals $\{2, 3\}$, while $S_{M,0}$ equals $\{0, 1, 2, 3\}$.

If Option 2 is applied, $S_{M,a}$ and $c_{a,m,l,k}$ shall satisfy the following:

$S_{M,a}$ shall consist of every Subframe number within $0 \leq m < N_{SF}$, regardless of the value of a . That is, $S_{M,a} = \{0, \dots, N_{SF} - 1\}$;

$c_{a,m,l,k}$ shall satisfy $c_{0,m,l,k} = c_{1,m,l,k}$ if m indicates a SISO Subframe.

L.12 PAPR REDUCTION

The Tone Reservation Peak to Average Power Ratio reduction technique, as described in Section 8.4.1, may be used with MIMO. The Active Constellation Extension (ACE) technique, as described in Section 8.4.2, shall not be used with MIMO.

L.13 CHANNEL BONDING

Channel bonding (see Annex K) may be used with MIMO and shall conform to this section when used. Channel bonding described in this section is defined for two RF channels. A block diagram in Figure L.13.1 shows the system architecture when channel bonding is used with MIMO. Following the stream partitioning process described in Section K.1, a single input data packet stream is partitioned into two separate Baseband Packet streams, each fed into the BICM chain for each RF channel. MIMO with channel bonding can also operate in two modes, plain channel bonding and SNR averaging, which can be selected by `L1D_plp_channel_bonding_format`. In Figure L.13.1, the solid lines depict blocks and arrows common to all configurations, while dashed lines denote blocks and arrows that may be disabled depending on the configuration settings related to MIMO and channel bonding.

Channel bonding with MIMO is not restricted to a bonding between MIMO PLPs but allows a bonding between SISO and MIMO PLPs. When plain channel bonding is used, a channel-bonded PLP can consist of a MIMO PLP and a SISO PLP, each transmitted onto different RF channels. In this case, the BICM chain encoding the engaged SISO PLP operates with MAP (see Section 6.3), while the MIMO PLP within the other RF channel applies MIMO MAP. If channel bonding with SNR averaging is used, a MIMO PLP shall not be channel-bonded with SISO PLP, thereby enabling low-complexity cell re-exchange on the receiver side as described in Section K.3.

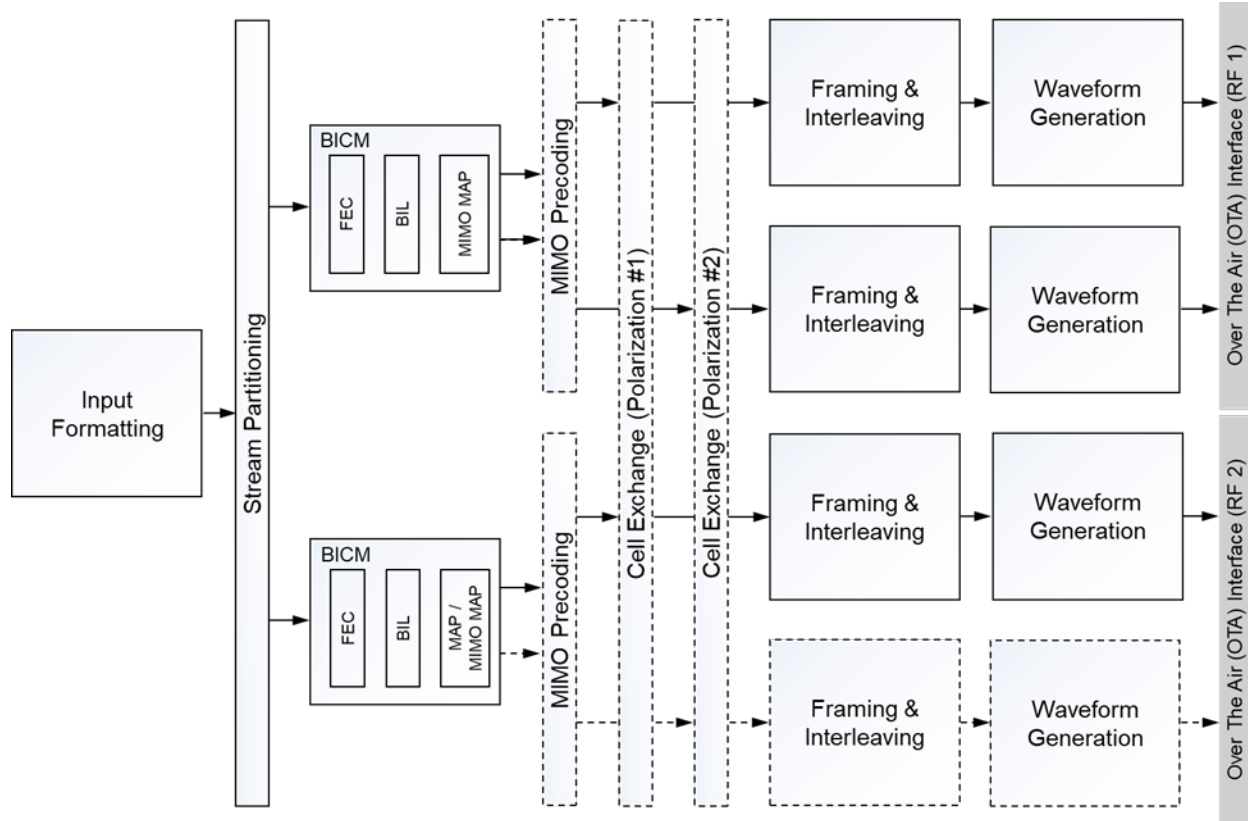

Figure L.13.1 Block diagram of the channel bonding with MIMO system architecture.

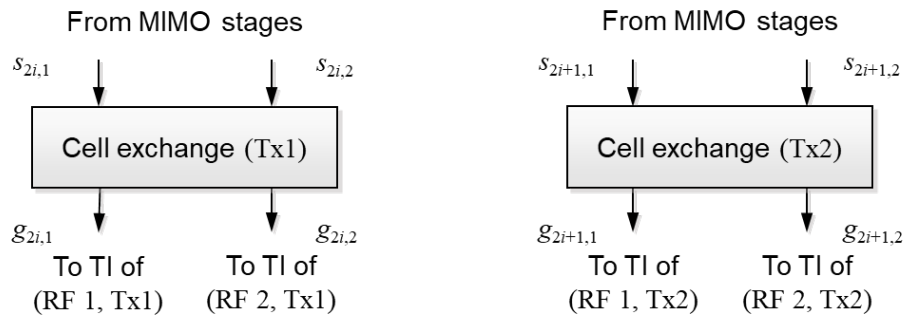

Figure L.13.2 Cell exchange block for each Polarization, Tx1 and Tx2.

When channel bonding with SNR averaging is used, the cell exchange block shall be applied Polarization-wise as shown in Figure L.13.2. A cell exchange matrix, defined for each Polarization, shall be multiplied to the vector including both cells for each input path at index i ($i = 0 \dots \lfloor N_{cells}/2 \rfloor - 1$):

$$\begin{pmatrix} g_{2i,1} \\ g_{2i,2} \end{pmatrix} = \begin{pmatrix} 1 & 0 \\ 0 & 1 \end{pmatrix} \cdot \begin{pmatrix} s_{2i,1} \\ s_{2i,2} \end{pmatrix} \text{ for } i \text{ even, with respect to the cells for Tx1}$$

$$\begin{pmatrix} g_{2i,1} \\ g_{2i,2} \end{pmatrix} = \begin{pmatrix} 0 & 1 \\ 1 & 0 \end{pmatrix} \cdot \begin{pmatrix} s_{2i,1} \\ s_{2i,2} \end{pmatrix} \text{ for } i \text{ odd, with respect to the cells for Tx1}$$

$$\begin{pmatrix} g_{2i+1,1} \\ g_{2i+1,2} \end{pmatrix} = \begin{pmatrix} 1 & 0 \\ 0 & 1 \end{pmatrix} \cdot \begin{pmatrix} s_{2i+1,1} \\ s_{2i+1,2} \end{pmatrix} \text{ for } i \text{ even, with respect to the cells for Tx2}$$

$$\begin{pmatrix} g_{2i+1,1} \\ g_{2i+1,2} \end{pmatrix} = \begin{pmatrix} 0 & 1 \\ 1 & 0 \end{pmatrix} \cdot \begin{pmatrix} s_{2i+1,1} \\ s_{2i+1,2} \end{pmatrix} \text{ for } i \text{ odd, with respect to the cells for Tx2,}$$

where the meaning of variables are as follows. The input cells fed into the cell exchange block for Tx1, $s_{2i,1}$ and $s_{2i,2}$, are associated with RF channels RF 1 and RF 2, respectively; the input cells fed into the cell exchange block for Tx2, $s_{2i+1,1}$ and $s_{2i+1,2}$, are associated with RF channels RF 1 and RF 2, respectively. The output cells produced from the cell exchange block for Tx1, $g_{2i,1}$ and $g_{2i,2}$, are associated with RF 1 and RF 2, respectively; the output cells produced from the cell exchange block for Tx2, $g_{2i+1,1}$ and $g_{2i+1,2}$, are associated with RF 1 and RF 2, respectively. The output cells are fed into the dedicated time interleaving blocks located on each corresponding path.

L.14 L1 SIGNALLING FOR MIMO

This section highlights the L1 signaling data specific to MIMO defined in Section 9.

The use of MIMO in the first Subframe of the current Frame is signaled in the Preamble with the L1-Basic parameter **L1B_first_sub_mimo**.

The use of MIMO in Subframes after the first Subframe of the current Frame is signaled in the Preamble with the L1-Detail parameter **L1D_mimo**.

The configuration of the MIMO precoding is signaled with the L1-Detail parameters **L1D_plp_mimo_stream_combining**, **L1D_plp_mimo_IQ_interleaving**, and **L1D_plp_mimo_PH**.

The choice of scattered pilot encoding scheme is signaled by **L1B_mimo_scattered_pilot_encoding**, which applies to all MIMO subframes in the current frame. When both SISO and MIMO subframes are present in the current frame, the SISO subframe shall conform to the pilot insertion process as detailed in Section 8.1 regardless of the value of **L1B_mimo_scattered_pilot_encoding**.

The choice of the scattered pilot pattern for MIMO is signaled with the L1-Basic parameter **L1B_first_sub_scattered_pilot_pattern** if MIMO is used in the first Subframe of the current Frame, and with the L1-Detail parameter **L1D_scattered_pilot_pattern** for Subframes after the first Subframe. These signaling parameters are also used for SISO but with a different interpretation.

The choice of the bits per cell use for MIMO is signaled with the L1-Detail parameter **L1D_plp_mod**. This signaling parameter is also used for SISO but with a different interpretation.

Annex M: Example of Peak to Average Power Ratio Reduction Algorithms

M.1 PAPR REDUCTION ALGORITHMS

The specific algorithms used to reduce peak to average power ratio are left to manufacturers to devise the most appropriate method for implementation on their equipment. For reference, Section M.2 outlines one algorithm for tone reservation (TR) and Section M.3 outlines a possible algorithm for the active constellation extension (ACE) method.

M.2 TR ALGORITHM

The tone reservation method consists of reserving a set of carriers N_{TR} to reduce the signal peaks.

The following definitions are used for the PAPR reduction algorithm description:

n The sample index, $0 \leq n < N_{FFT}$.

i The iteration number of the TR algorithm.

x_n The n -th sample of the complex baseband time-domain input to the TR algorithm.

x'_n The n -th sample of the complex baseband time-domain output of the TR algorithm.

$c_n^{(i)}$ The n -th sample of the time-domain reduction signal in the i -th iteration of the TR algorithm.

$r_k^{(i)}$, The modulation value in the i -th iteration for the reserved tone whose carrier index is k .

p_n The n -th sample of the reference kernel signal, defined by:

$$p_n = \frac{1}{N_{TR}} \sum_{k \in S_l} e^{j \frac{2\pi n(k-K_c)}{N_{FFT}}}$$

where l is the OFDM symbol index and S_l is the set of reserved carrier indices for symbol l , and $K_c = (K_{\max} + K_{\min})/2$ is the index k of the center (“DC”) carrier.

Note 1: The reference kernel corresponds to the inverse Fourier Transform of a $(N_{FFT}, 1)$ vector \mathbf{I}_{TR} having N_{TR} elements of ones at the positions corresponding to the reserved carrier indices $k \in S_l$.

This PAPR reduction algorithm is described below.

Initialization:

The initial values for the peak reduction signal are set to zero:

$$c_n^{(0)} = 0, \quad 0 \leq n < N_{FFT}$$

$$r_k^{(0)} = 0, k \in S_I$$

Iteration:

- 1) i starts from 1.
- 2) Find the maximum magnitude of $x_n + c_n^{(i-1)}$, denoted by $y^{(i)}$, and the corresponding sample index, $m^{(i)}$ in the i -th iteration.

$$\begin{cases} y^{(i)} = \max_n |x_n + c_n^{(i-1)}| \\ m^{(i)} = \arg \max_n |x_n + c_n^{(i-1)}| \end{cases}, \quad \text{for } n = 0, 1, \dots, N_{FFT} - 1,$$

If $y^{(i)}$ is less than or equal to a desired clipping magnitude level, V_{clip} then decrease i by 1 and go to step 9.

- 3) Calculate a unit-magnitude phasor $u^{(i)}$ in the direction of the peak to be cancelled:

$$u^{(i)} = \frac{x_{m^{(i)}} + c_{m^{(i)}}^{(i-1)}}{y^{(i)}}$$

- 4) For each reserved tone, calculate the maximum magnitude of correction $\alpha_k^{(i)}$ that can be applied without causing the reserved carrier amplitude to exceed the maximum allowed

value $A_{\max} = \frac{5\sqrt{10} \times N_{TR}}{\sqrt{27K_{\text{total}}}}$ as follows:

$$\alpha_k^{(i)} = \sqrt{A_{\max}^2 - \text{Im} \left\{ \left(v_k^{(i)} \right)^* r_k^{(i-1)} \right\}^2 + \text{Re} \left\{ \left(v_k^{(i)} \right)^* r_k^{(i-1)} \right\}}$$

$$\text{where } v_k^{(i)} = u^{(i)} \exp \left(-\frac{j2\pi(k - K_C)m^{(i)}}{N_{FFT}} \right)$$

- 5) Find $\alpha^{(i)}$, the largest magnitude of correction allowed without causing any reserved carrier amplitudes to exceed A_{\max} :

$$\alpha^{(i)} = \min \left(y^{(i)} - V_{clip}, \min_{k \in S_I} \alpha_k^{(i)} \right)$$

If $\alpha^{(i)} = 0$, then decrease i by 1 and go to step 9.

- 6) Update the peak reduction signal $c_n^{(i)}$ by subtracting the reference kernel signal, scaled and cyclically shifted by $m^{(i)}$:

$$c_n^{(i)} = c_n^{(i-1)} - \alpha^{(i)} u^{(i)} p_{(n-m^{(i)}) \bmod N_{FFT}}$$

- 7) Update the frequency domain coefficient for each reserved tone $k \in S_I$:

$$r_k^{(i)} = r_k^{(i-1)} - \alpha^{(i)} v_k^{(i)},$$

Note 2: If only 1 iteration is required, step 7 can be omitted, and steps 4 and 5 reduce to the following:

$$\alpha^{(1)} = \min(y^{(1)} - V_{clip}, A_{max}).$$

- 8) If i is less than a maximum allowed number of iterations, increase i by 1 and return to step 2. Otherwise, go to step 9.
- 9) Terminate the iterations. The transmitted signal, x'_n is obtained by adding the peak reduction signal to the data signal:

$$x'_n = x_n + c_n^{(i)}$$

M.3 ACE ALGORITHMS

Two types of algorithms for active constellation extension are proposed, the use of which depends upon the constellation dimension and the FEC code rate. The 1-dimensional (1D) constellation algorithm is described in Section M.3.1 and the 2-dimensional (2D) constellation algorithm is described in Section M.3.2. Table M.3.1 indicates the ACE algorithm to be used for each modulation and coding combination.

Table M.3.1 ACE Algorithm Used for Each Modulation and Code Rate Combination

Code Rate/ Constellation	2/ 15	3/ 15	4/ 15	5/ 15	6/ 15	7/ 15	8/ 15	9/ 15	10/ 15	11/ 15	12/ 15	13/ 15
QPSK	1D	1D	1D	1D	1D	1D	1D	1D	1D	1D	1D	1D
16QAM	1D	2D	2D	2D	2D	2D	2D	2D	2D	1D	1D	1D
64QAM	2D	2D	2D	2D	2D	2D	2D	2D	2D	2D	2D	2D
256QAM	2D	2D	2D	2D	2D	2D	2D	2D	2D	2D	2D	2D
1024QAM	1D	1D	1D	1D	1D	1D	1D	1D	1D	1D	1D	1D
4096QAM	1D	1D	1D	1D	1D	1D	1D	1D	1D	1D	1D	1D

The Active Constellation Extension algorithm produces a time domain signal x_{ACE} that replaces the original time domain signal $x = [x_0, x_1, \dots, x_{N_{FFT}-1}]$ produced by the IFFT from a set of frequency domain values $X = [X_0, X_1, \dots, X_{N_{FFT}-1}]$.

M.3.1 1-D ACE algorithm

The 1-D ACE algorithm is used for the 1-dimensional constellations.

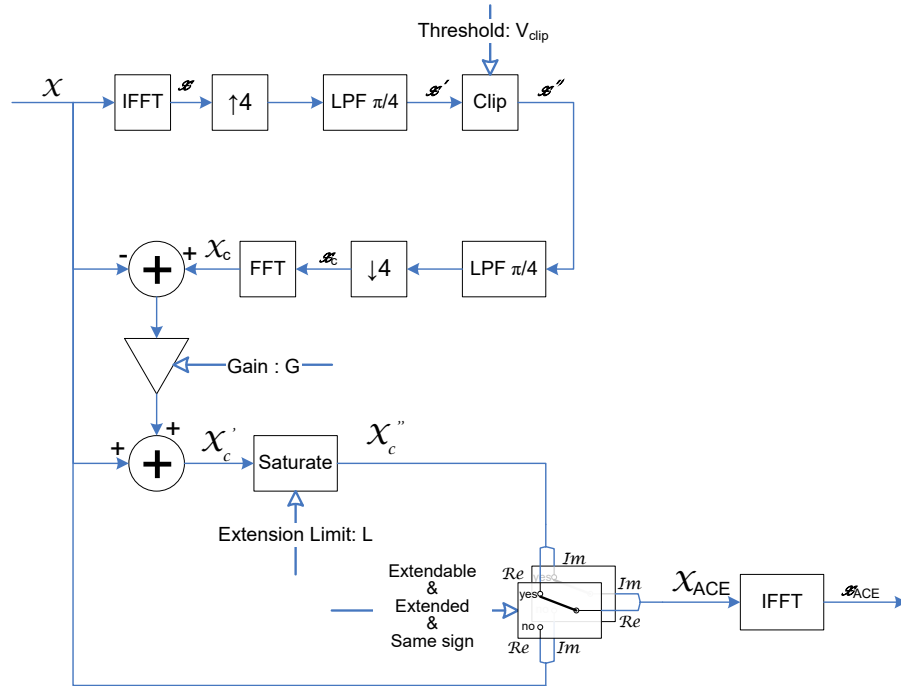

Figure M.3.1 Implementation example of the ACE algorithm for 1-D constellations.

$x' = [x'_0, x'_1, \dots, x'_{N_{FFT}-1}]$ is obtained from x through interpolation by a factor of 4.

The combination of IFFT, oversampling and lowpass filtering is implemented using zero padding and a four times oversized IFFT operator.

$x'' = [x''_0, x''_1, \dots, x''_{N_{FFT}-1}]$ is obtained by applying a clipping operator to x' .

The clipping operator is defined as follows:

$$x''_k = \begin{cases} x'_k & , \text{ if } |x'_k| \leq V_{clip} \\ V_{clip} \cdot \frac{x'_k}{|x'_k|} & , \text{ if } |x'_k| > V_{clip} \end{cases}$$

The clipping threshold V_{clip} is a parameter of the ACE algorithm.

$x_c = [x_{c0}, x_{c1}, \dots, x_{cN_{FFT}-1}]$ is obtained from x'' through decimation by a factor of 4.

The combination of lowpass filtering, downsampling and FFT is implemented using a four times oversized FFT operator.

X_c is obtained from x_c through an FFT operation.

A new signal X'_c is obtained by combining X_c and X as follows:

$$X'_c = X + G \cdot (X_c - X)$$

The extension gain G is a parameter of the ACE algorithm.

X''_c is obtained from X'_c using a saturation operator which operates separately with real and imaginary components, ensuring that individual component magnitude cannot exceed a given value L .

$$\text{Re}\{X''_{c,k}\} = \begin{cases} \text{Re}\{X'_{c,k}\}, & \text{if } |\text{Re}\{X'_{c,k}\}| \leq L; \\ L, & \text{if } \text{Re}\{X'_{c,k}\} > L; \\ -L, & \text{if } \text{Re}\{X'_{c,k}\} < -L; \end{cases}$$

$$\text{Im}\{X''_{c,k}\} = \begin{cases} \text{Im}\{X'_{c,k}\}, & \text{if } |\text{Im}\{X'_{c,k}\}| \leq L; \\ L, & \text{if } \text{Im}\{X'_{c,k}\} > L; \\ -L, & \text{if } \text{Im}\{X'_{c,k}\} < -L; \end{cases}$$

The extension limit L is a parameter of the ACE algorithm.

X_{ACE} is then constructed by simple selection of the real and imaginary components from those of X , X'_c .

$$\text{Re}\{X_{ACE,k}\} = \begin{cases} \text{Re}\{X''_{c,k}\}, & \begin{array}{l} \text{if } \text{Re}\{X_k\} \text{ is extendable} \\ \text{AND } |\text{Re}\{X''_{c,k}\}| \leq |\text{Re}\{X_k\}| \\ \text{AND } \text{Re}\{X''_{c,k}\} \cdot \text{Re}\{X_k\} > 0 \end{array} \\ \text{Re}\{X_k\}, & \text{otherwise} \end{cases}$$

$$\text{Im}\{X_{ACE,k}\} = \begin{cases} \text{Im}\{X''_{c,k}\}, & \begin{array}{l} \text{if } \text{Im}\{X_k\} \text{ is extendable} \\ \text{AND } |\text{Im}\{X''_{c,k}\}| \leq |\text{Im}\{X_k\}| \\ \text{AND } \text{Im}\{X''_{c,k}\} \cdot \text{Im}\{X_k\} > 0 \end{array} \\ \text{Im}\{X_k\}, & \text{otherwise} \end{cases}$$

x_{ACE} is obtained from X_{ACE} through an IFFT operation.

A component is defined as extendable if it is an active cell (i.e. an OFDM cell carrying a constellation point), and if its absolute amplitude is greater than or equal to the maximal component value associated to the modulation constellation used for that cell; a component is also defined as extendable if it is a dummy cell or a null cell in a Subframe boundary symbol. As an example, a component belonging to a 1024QAM 9/15 modulated cell is extendable if its absolute amplitude is greater than or equal to 1.4646. (see values $u/5$ in Table C.1.9)

The value for the gain G is selectable in the range between 1 and 31 in steps of 1.

The clipping threshold V_{clip} is selectable in the range between +0 dB and +12.7 dB in 0.1 dB steps above the standard deviation of the original time-domain signal.

The maximal extension value L is selectable in the range between 0.7 and 2.4 in 0.1 steps.

M.3.2 2-D ACE Algorithm

The 2-D ACE algorithm is used for the 2-dimensional constellations.

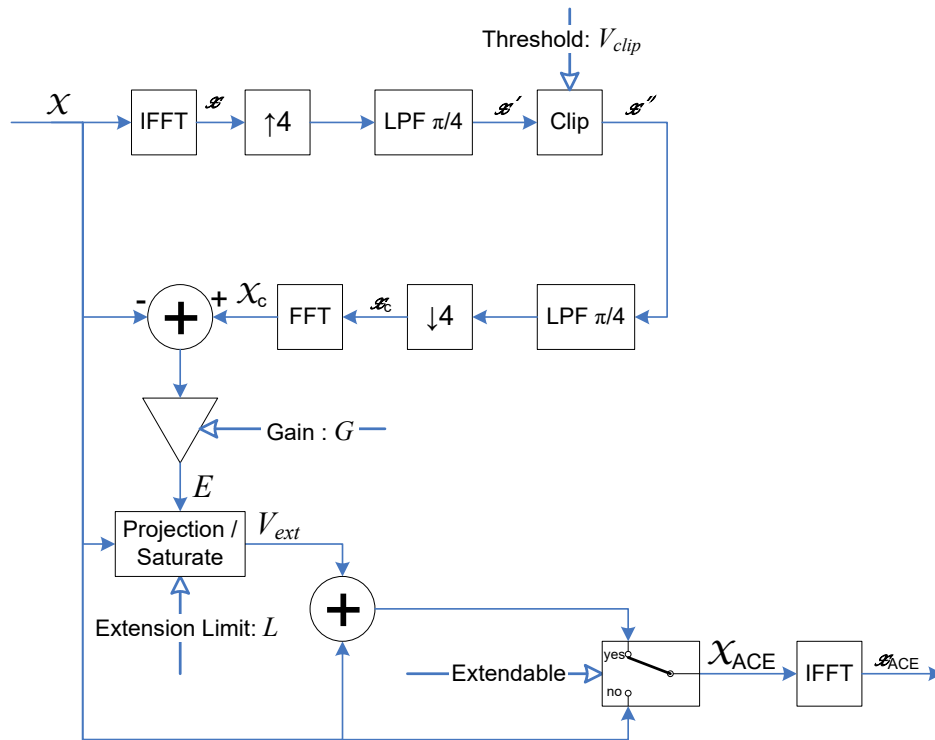

Figure M.3.2 Implementation example of the ACE algorithm for 2-D constellations.

$x' = [x'_0, x'_1, \dots, x'_{N_{FFT}-1}]$ is obtained from x through interpolation by a factor of 4.

The combination of IFFT, oversampling and lowpass filtering is implemented using zero padding and a four times oversized IFFT operator.

$x'' = [x''_0, x''_1, \dots, x''_{N_{FFT}-1}]$ is obtained by applying a clipping operator to x' .

The clipping operator is defined as follows:

$$x''_k = \begin{cases} x'_k & , \text{ if } |x'_k| \leq V_{clip} \\ V_{clip} \cdot \frac{x'_k}{|x'_k|} & , \text{ if } |x'_k| > V_{clip} \end{cases}$$

The clipping threshold V_{clip} is a parameter of the ACE algorithm.

$x_c = [x_{c0}, x_{c1}, \dots, x_{cN_{FFT}-1}]$ is obtained from x'' through decimation by a factor of 4.

The combination of lowpass filtering, downsampling and FFT is implemented using a four times oversized FFT operator.

X_c is obtained from x_c through FFT.

The Error vector E is obtained by combining X_c and X as follows:

$$E = G \cdot (X_c - X)$$

The extension gain G is a parameter of the ACE algorithm.

The Extension vector V_{ext} is obtained as follows:

$$\arg(V_{ext,k}) = \begin{cases} \frac{\theta}{2}, & \text{if } \frac{\theta}{2} < \varphi_{e,k} < 90^\circ; \\ -\frac{\theta}{2}, & \text{if } -90^\circ < \varphi_{e,k} < -\frac{\theta}{2}; \\ \varphi_{e,k}, & \text{otherwise} \end{cases}$$

$$|V_{ext,k}| = \begin{cases} |E_k|, & \text{if } (|E_k| \leq L - |X_k|) \text{ AND } (-90^\circ < \varphi_{e,k} < 90^\circ) \\ L - |X_k|, & \text{if } (|E_k| > L - |X_k|) \text{ AND } (-90^\circ < \varphi_{e,k} < 90^\circ) \\ 0, & \text{otherwise} \end{cases}$$

Where φ_e denotes the angle between the argument of reference symbol X and the Error vector E . The extension limit L is an input parameter of the ACE algorithm.

The angle θ is an input parameter of the ACE block and is dependent upon the 2-dimensional constellation and code rate. The values of angle θ (in degrees) are given in Table M.3.2.

Table M.3.2 Values of Angle θ of ACE Algorithm for 2-Dimensional Constellations

Code Rate/ Cont.	2/ 15	3/ 15	4/ 15	5/ 15	6/ 15	7/ 15	8/ 15	9/ 15	10/ 15	11/ 15	12/ 15	13/ 15
16QAM	NA	33.26°	35.6°	38.5°	44.14°	44.1°	44.49°	44.49°	42.1°	NA	NA	NA
64QAM	22.96°	39.36°	41.26°	19.01°	21.17°	22.49°	22.28°	22.49°	22.4°	19.75°	18.42°	16.81°
256QAM	36.67°	40.26°	19.11°	22.47°	8.38°	11.23°	11.23°	10.93°	11.22°	10.63°	8.8°	8.34°

X_{ACE} is then constructed by adding the Extension vector V_{ext} to the signal X as follows:

$$X_{ACE,k} = \begin{cases} X_k + V_{ext,k}, & \text{if } X_k \text{ is extendable;} \\ X_k, & \text{otherwise} \end{cases}$$

x_{ACE} is obtained from X_{ACE} through an IFFT operation.

A component X_k is defined as extendable if it is an active cell (i.e. an OFDM cell carrying a constellation point), and if it carries a boundary point of the modulation constellation used for that cell. A component is also defined as extendable if it is a dummy cell or a null cell in a Subframe boundary symbol. As an example, a component belonging to a 256QAM 9/15 modulated cell is a boundary point of the constellation if its modulus is greater than or equal to 1.65.

The value for the gain G is selectable in the range between 1 and 31 in steps of 1.

The clipping threshold V_{clip} is selectable in the range between +0 dB and +12.7 dB in 0.1 dB steps above the standard deviation of the original time-domain signal.

The maximal extension value L is selectable in the range between 0.7 and 2.4 in 0.1 steps.

M.3.3 2-D ACE Constellation Diagrams

The following figures show graphically the 2-dimensional constellation extension using the 2-D ACE algorithm.

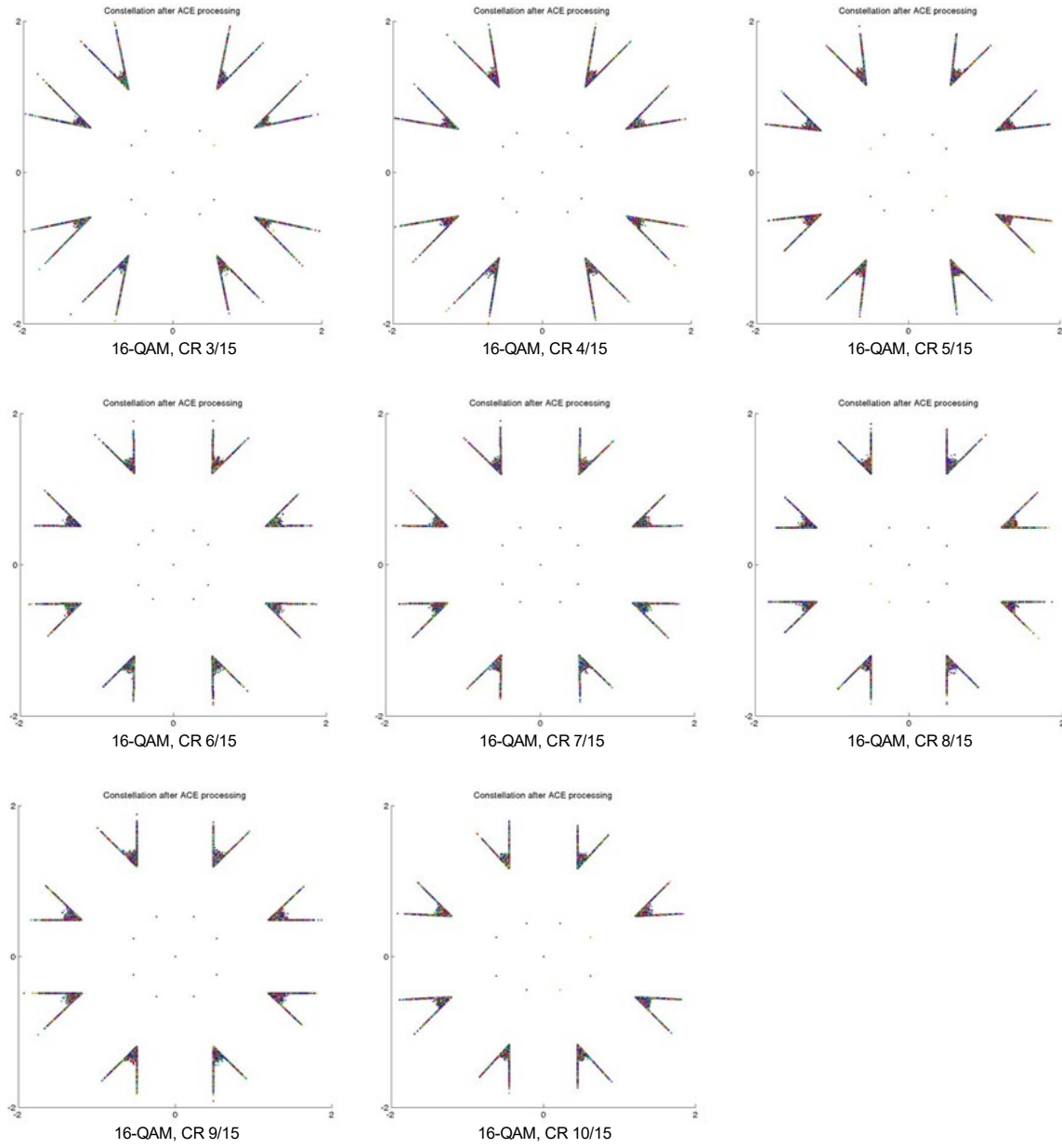

Figure M.3.3 Constellation diagram for 16QAM when using the defined ACE algorithm.

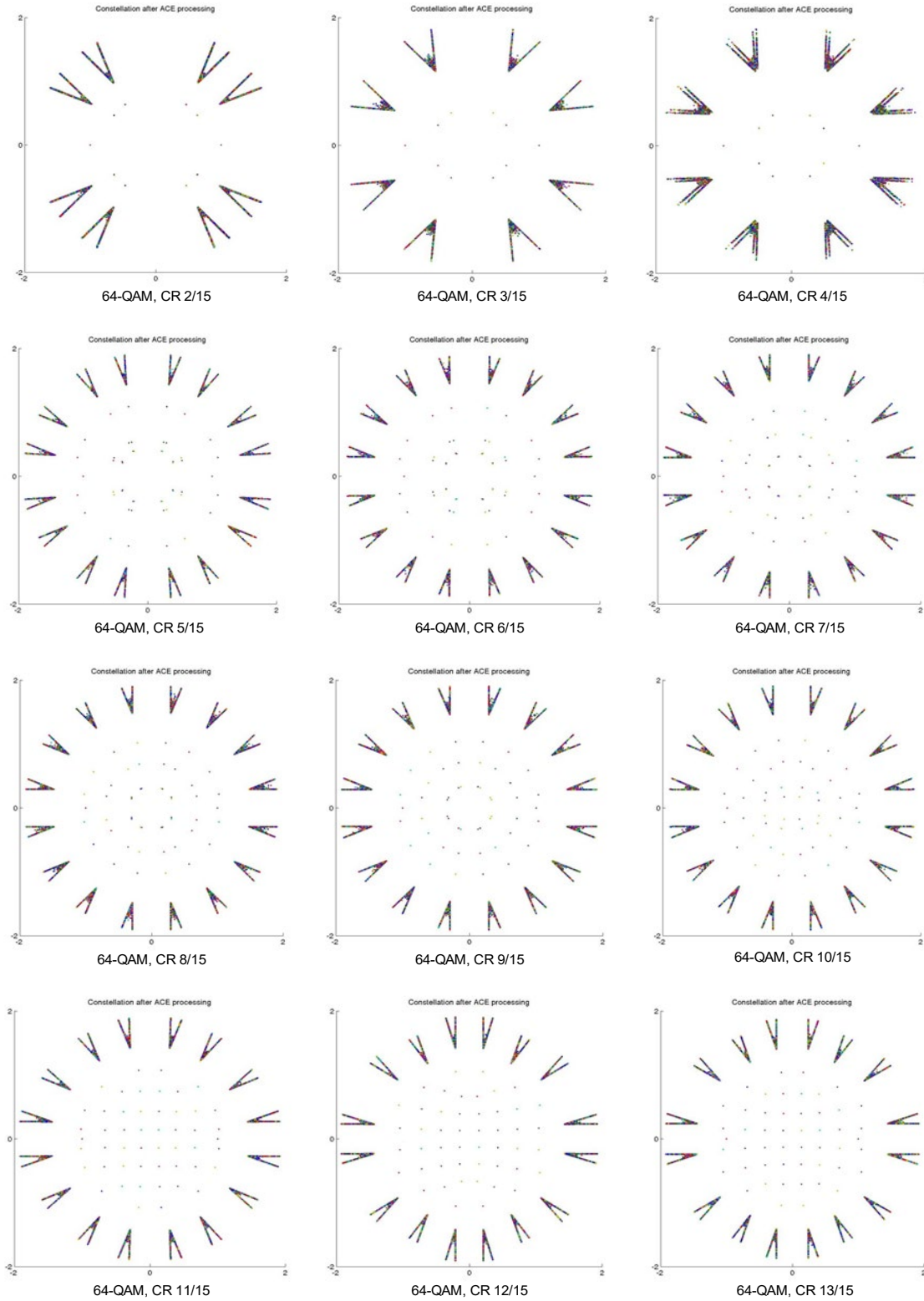

Figure M.3.4 Constellation diagram for 64QAM when using the defined ACE algorithm.

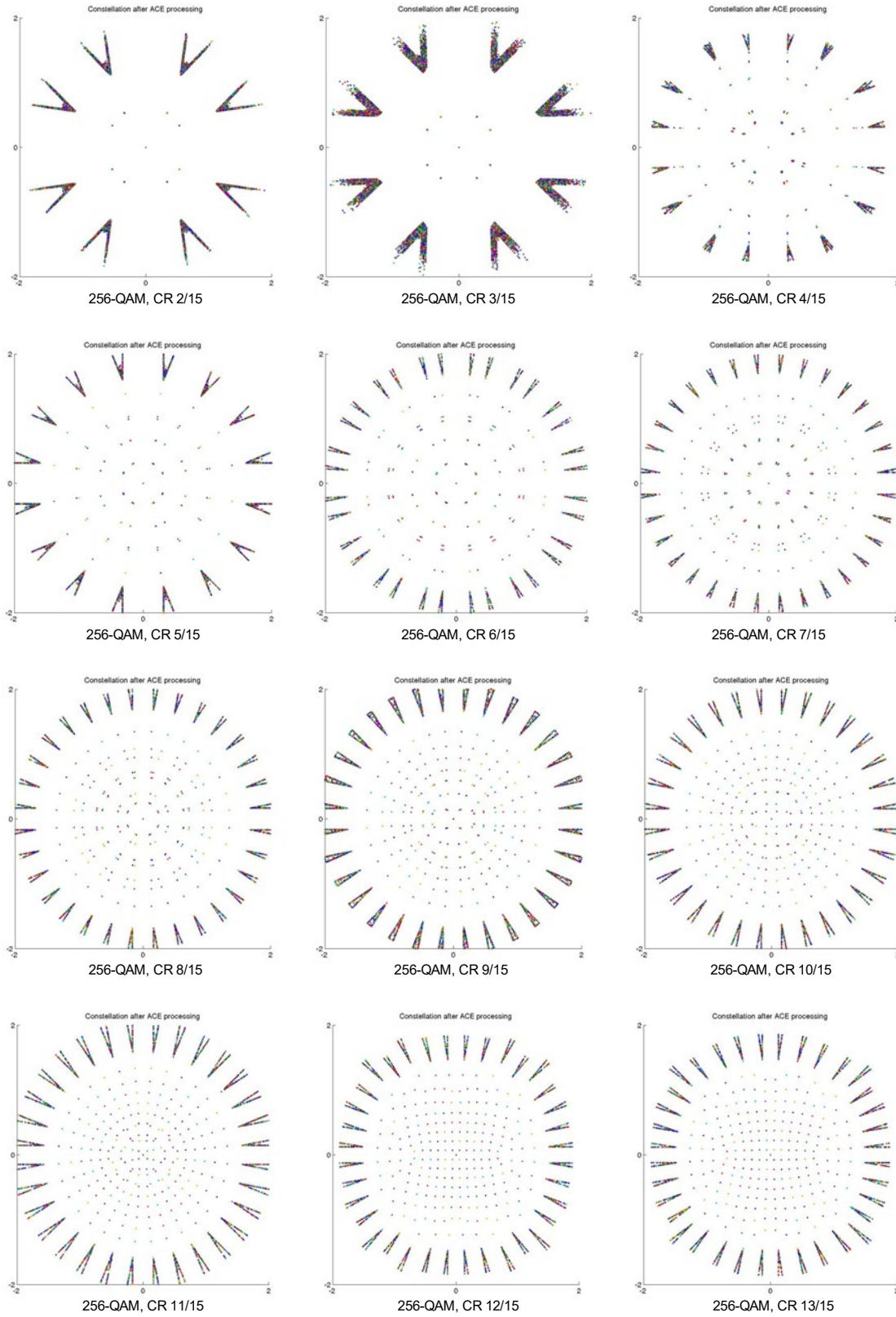

Figure M.3.5 Constellation diagram for 256QAM when using the defined ACE algorithm.

Annex N: Transmitter Identification (TxID)

N.1 OVERVIEW

Transmitter identification (TxID) allows uniquely identifying each individual transmitter. Identification is achieved via an RF watermark, which enables system monitoring and measurements, interference source determination, geolocation, and other applications. One of the specific uses of the TxID signal is to allow channel impulse response components of each transmitter to be measured independently to support in-service system adjustments including the power levels and delay offsets of individual transmitters. Such channel impulse response information can be measured by special monitoring instruments but does not need to be processed or otherwise dealt with by ordinary consumer ATSC 3.0 receivers, i.e., the TxID signal appears to such receivers as a small amount of noise in the ATSC 3.0 waveform. TxID is an optional technology but when adopted shall conform to the requirements of this Annex.

Figure N.1.1 depicts the block diagram of the overall transmission system architecture including TxID signal generation. If instructed to do so by signaling from the controlling scheduler, each transmitter in a network will include its TxID in its over-the-air transmission. The TxID signal is a direct sequence buried spread spectrum (DSBSS) RF watermark signal carrying a unique Gold code sequence. Each TxID signal is injected into the host ATSC 3.0 signal in the time domain and is transmitted synchronously with the host ATSC 3.0 signal.

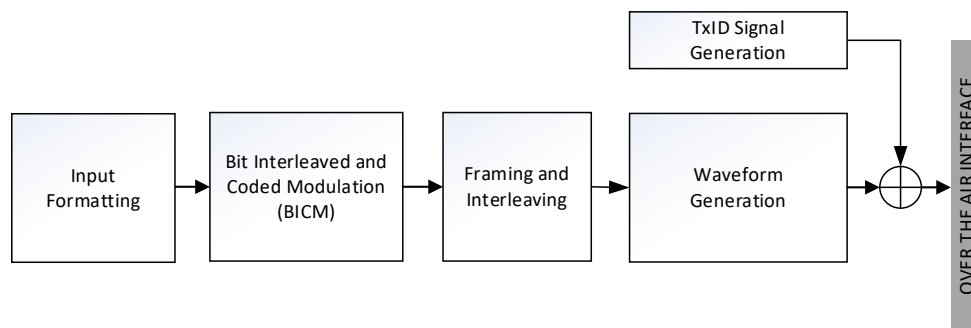

Figure N.1.1 TxID generation and injection into ATSC 3.0 host signals.

N.2 CODE GENERATION

The TxID signal carries a Gold code sequence that is unique to each transmitter on a given RF channel within the largest possible geographic region and is transmitted only within the first Preamble symbol period as depicted from Figure N.2.1 to Figure N.2.3, where it is added at a reduced level relative to the emissions from the particular transmitter with which it is associated. The code is generated by a pair of shift registers having specified feedback arrangements and set to known values at specified times. The shift registers are clocked at the same baseband sample rate as is used for the host ATSC 3.0 Preamble.

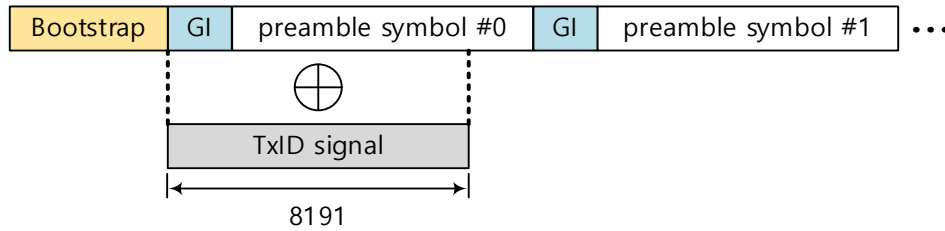

Figure N.2.1 TxID signal injection into the first Preamble symbol period (8K FFT).

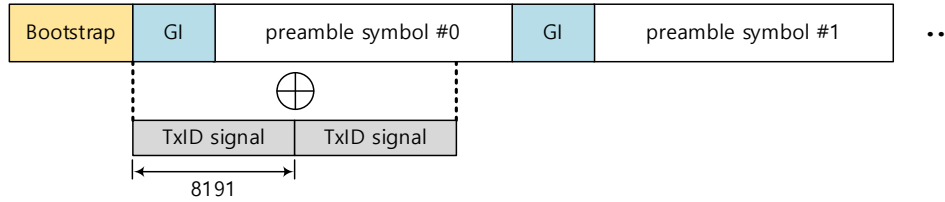

Figure N.2.2 TxID signal injection into the first Preamble symbol period (16K FFT).

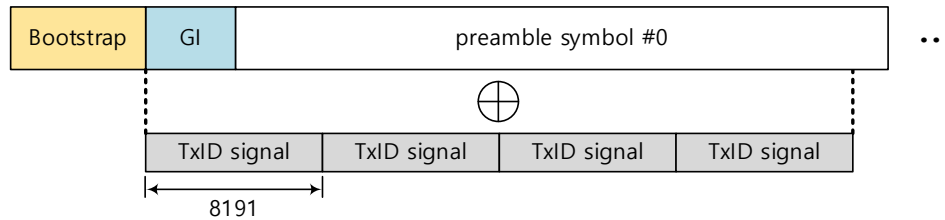

Figure N.2.3 TxID signal injection into the first Preamble symbol period (32K FFT).

N.2.1 Multiple Shift Registers

The code transmitted by the TxID signal shall be generated by a pair of shift registers that shall have the lengths, feedback paths, and summing functions defined in Figure N.2.4. The shift registers also shall have inputs through which they can be preloaded during specified setup intervals. The combined output of the shift registers shall be sent to the BPSK modulator described in Section N.3.1 for subsequent injection into and transmission with the ATSC 3.0 host signal.

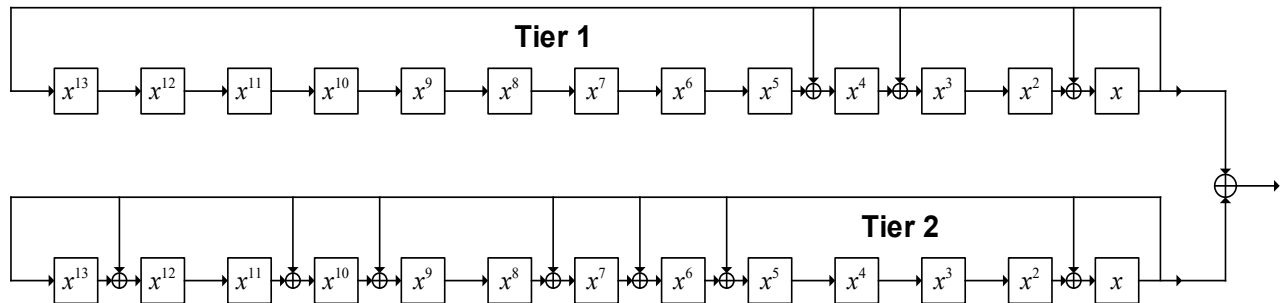

Figure N.2.4 TxID code generator based on Gold sequence.

The two shift registers shall be defined by the following generator polynomials:

- Tier 1 generator polynomial: $x^{13} + x^4 + x^3 + x + 1$
- Tier 2 generator polynomial: $x^{13} + x^{12} + x^{10} + x^9 + x^7 + x^6 + x^5 + x + 1$

N.2.2 Clock Rate

The clock applied to the shift registers shown in Figure N.2.4 shall operate at the baseband sample rate of the host ATSC 3.0 payload signal, as defined by the **bsr_coefficient** field of bootstrap symbol 2 [2]. For example, if the signaled value of **bsr_coefficient** were 2, then the baseband sample rate would be $6.912 = (0.384 \times (2+16))$ MHz.

N.2.3 Preloaded Values

Each of the two shift registers shown in Figure N.2.4 shall be preloaded prior to the generation of the TxID sequence for each Frame. The shift register in Tier 1 of the Gold code sequence generator of Figure N.2.4 shall be preloaded with a value of 1 in the x stage and 0 in all the other stages. A 13-bit **txid_address** shall be preloaded into the x^{13} through x stages of the Tier 2 shift register of the code sequence generator; the MSB shall be preloaded into the x^{13} stage and the LSB into the x stage. A **txid_address** value shall be uniquely assigned to each transmitter on a given RF channel, and that value shall be used by the scheduler for controlling each individual transmitter. The preloading of the shift registers of the code sequence generator shall be as defined in Table N.2.1. In the table, values denoted as t are the respective bits of the **txid_address** field with t_{12} representing the MSB and t_0 representing the LSB. According to Table N.2.1, the TxID sequence has a total length of $2^{13} - 1 = 8191$ bits, and the total number of sequences that can be assigned to individual transmitters is $2^{13} = 8192$.

Table N.2.1 Code Sequence Generator Preloading

	Tier 1	Tier 2
x^{13}	0	t_{12}
x^{12}	0	t_{11}
x^{11}	0	t_{10}
x^{10}	0	t_9
x^9	0	t_8
x^8	0	t_7
x^7	0	t_6
x^6	0	t_5
x^5	0	t_4
x^4	0	t_3
x^3	0	t_2
x^2	0	t_1
x	1	t_0

N.2.4 Synchronization with Preamble Symbol

The first bit of the TxID pattern shall be output from the shift register arrangement of Figure N.2.4 after the shift registers have been preloaded and after the shift registers have been clocked for the first time after the preloading. This first TxID bit shall be modulated and emitted simultaneously with the first sample of the first Preamble symbol including that symbol's guard interval. The

second TxID bit shall be modulated and emitted simultaneously with the second sample of the first Preamble symbol including that symbol's guard interval, and so on.

When an 8K FFT Preamble symbol is used, the TxID sequence that has a length of 8191 bits shall be emitted once per Frame as depicted in Figure N.2.1. When a 16K FFT Preamble symbol is used, the TxID sequence of length 8191 shall be repeated twice within the first Preamble symbol period so that the total length of the TxID sequence shall be 16382 bits as depicted in Figure N.2.2. In this case, the second TxID sequence shall have the opposite polarity to the first TxID sequence in order to average out DC components. When a 32K FFT Preamble symbol is used, the TxID sequence of length 8191 shall be repeated four times within the first Preamble symbol period so that the total length of the TxID sequence shall be 32764 bits as depicted in Figure N.2.3. In this case, the second and fourth TxID sequences shall have the opposite polarities to the first TxID sequence, while the third TxID sequence shall have the same polarity as the first TxID sequence. The FFT size of the Preamble symbols is indicated by the **preamble_structure** parameter of bootstrap symbol 3 as defined in Table H.1.1.

N.3 CODE TRANSMISSION

N.3.1 BPSK Modulation

The generated Gold code sequence shall be BPSK modulated before injection into the host ATSC 3.0 Preamble symbol. If the generated sequence bit is 'zero', it shall be modulated as '-1'. If the generated sequence bit is 'one', it shall be modulated as '+1'. The BPSK modulated TxID signal shall be injected into the in-phase part of the host ATSC 3.0 Preamble and shall not be injected into the quadrature part.

N.3.2 TxID Injection Level

A wide range of injection levels for injecting a TxID signal into the host ATSC 3.0 Preamble is available so that an operator can minimize the performance degradation of the Preamble while maintaining the desired TxID detection performance. The TxID injection level to use, including turning off emission of the TxID signal, shall be provided from the controlling scheduler to transmitter(s).

The TxID injection level shall be defined by the dB values in Table N.3.1, and the scaled TxID signals shall be injected into the host ATSC 3.0 Preamble immediately following the bootstrap. Note that the dB values are exact, while the linear scaling factors in italics are approximate.

Table N.3.1 TxID Injection Levels Below Host ATSC 3.0 Preamble

TxID Injection Level Code	TxID Injection Level Below Preamble (dB)	Scaling Factor (Amplitude)
0000	OFF	0
0001	45.0 dB	0.0056234
0010	42.0 dB	0.0079433
0011	39.0 dB	0.0112202
0100	36.0 dB	0.0158489
0101	33.0 dB	0.0223872
0110	30.0 dB	0.0316228
0111	27.0 dB	0.0446684
1000	24.0 dB	0.0630957
1001	21.0 dB	0.0891251
1010	18.0 dB	0.1258925
1011	15.0 dB	0.1778279
1100	12.0 dB	0.2511886
1101	9.0 dB	0.3548134
1110	Reserved	-
1111	Reserved	-

N.4 SIGNALING FIELDS

Signaling fields for control of TxID emission are defined within [4].

N.5 MIMO

When MIMO is used, TxID can identify not only individual transmitters but also each transmitting Polarization within the transmitter. The value of **txid_address** and TxID injection level can be independently assigned to each transmitting Polarization within the MIMO transmitter.

Annex O: Combination of LDM and MIMO

O.1 OVERVIEW

The combination of LDM and MIMO, referenced as Layered MIMO, increases spectral efficiency by integrating two different multiplexing gains from independent domains: (1) LDM gain from spectrum reuse, and (2) MIMO gain from spatial multiplexing. Layered MIMO is an extension of the MIMO technology described in Annex L specific to multiplexing scenarios with multiple PLPs in which at least one MIMO PLP is included. Layered MIMO is an optional technology but, when adopted, shall conform to the requirements in this Annex.

In this version of the specification, the Layered MIMO system is restricted to a two-layer LDM with a MIMO-encoded Enhanced Layer. The Core Layer can be either SISO or MIMO. Depending on the form of the Core Layer, one of two types of Layered MIMO is applied as follows:

- Layered MIMO Type A: Both Core and Enhanced PLPs use MIMO.
- Layered MIMO Type B: Core PLPs use SISO, and Enhanced PLPs use MIMO.

MIMO processing in Layered MIMO uses 2×2 cross-polarized antenna systems (e.g., having horizontally and vertically polarized elements or possibly having elements rotated 45 degrees in the same direction from horizontal and vertical) (see Annex L). At least two effective antenna units must be present at transmitter locations, while antenna requirements for receivers can vary depending on the signals intended to be received. If a service carried by a MIMO PLP is to be received, receivers should include cross-polar pairs of antennas or more. If a SISO-carried service is to be received, receivers may operate with single antennas or sets of diversity antennas. Receivers capable of decoding MIMO PLPs also must support SISO decoding. In cases when Layered MIMO Type B is applied, compatibility with MIMO operations determines a receiver's capability to decode each signal layer.

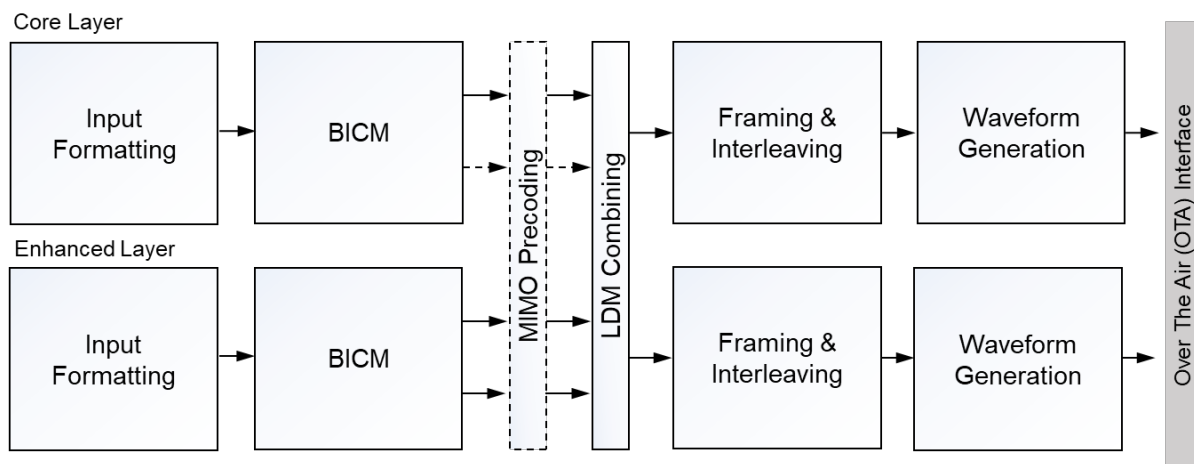

Figure O.1.1 Comprehensive block diagram for Layered MIMO.

Figure O.1.1 depicts a comprehensive block diagram for a Layered MIMO system. The Layered MIMO transmission chain reuses as many blocks as possible from SISO, including FEC codes, bit interleavers, constellations, and frequency and time interleavers. All blocks not specifically mentioned in this Annex, such as input formatting and guard interval, shall follow their specifications for SISO.

Not all blocks are used in every configuration. In Figure O.1.1, solid lines represent blocks common to all configurations, while dashed lines indicate blocks that can be disabled or partly applied, depending on whether the configuration is Type A or B. Solid arrows depict signal flows common to all configurations, and dashed arrows show signal flows specific to Layered MIMO Type A. The structure realization for each Layered MIMO type is specified in Figure O.1.2 and Figure O.1.3.

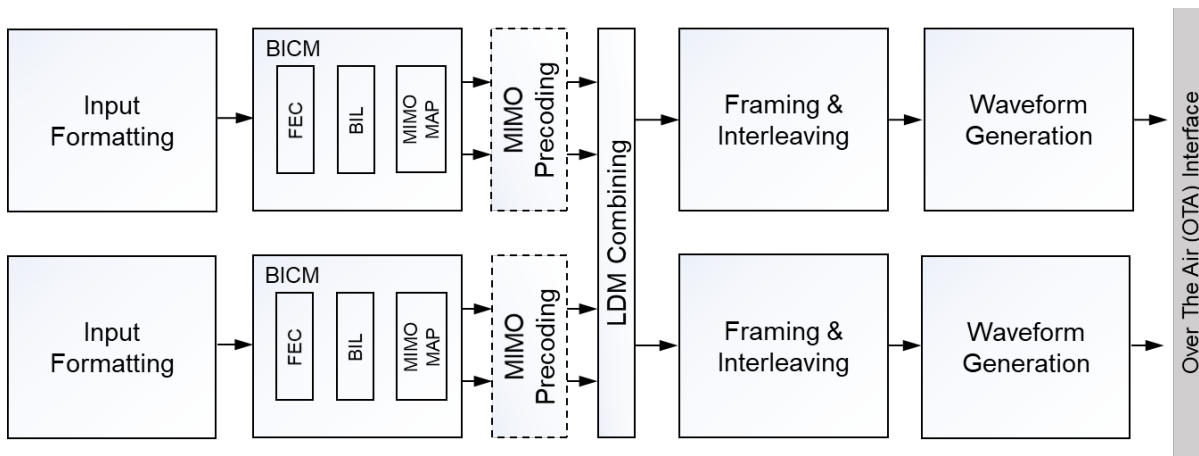

Figure O.1.2 Block diagram of Layered MIMO Type A.

Figure O.1.2 depicts a block diagram of Layered MIMO specific to Type A. Layered MIMO Type A is a simple combining between MIMO PLPs. The constellation superposition in this configuration shall be applied with respect to Polarization, i.e., the Core PLP’s constellation symbol associated with Polarization #1 shall be superposed with the Enhanced PLP’s constellation symbol associated with Polarization #1, and the same applies to Polarization #2.

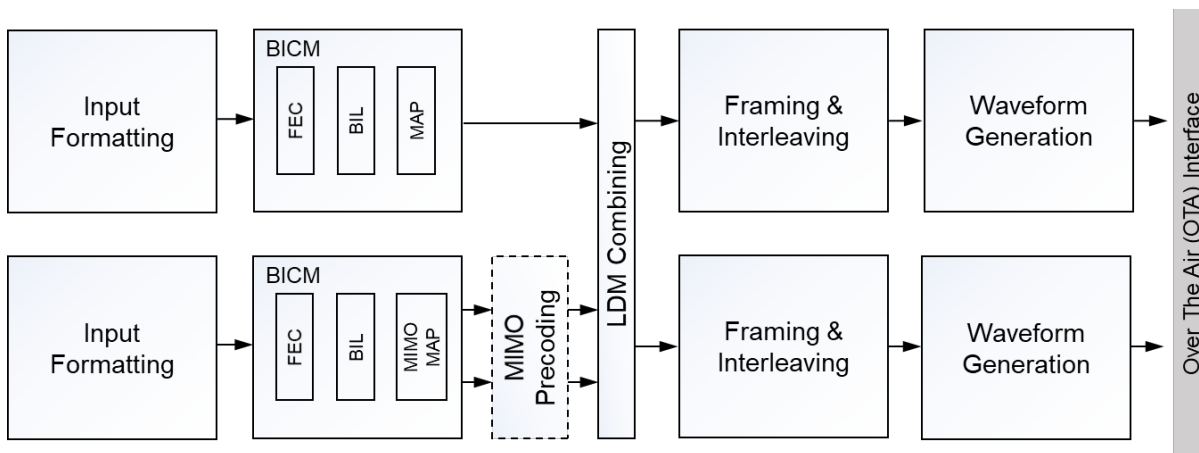

Figure O.1.3 Block diagram of Layered MIMO Type B.

Figure O.1.3 depicts a block diagram of Layered MIMO specific to Type B. Layered MIMO Type B multiplexes SISO and MIMO PLPs within a Subframe. This multiplexing scheme allows receivers compatible only with SISO to receive Core PLP(s) without being impacted by the presence of Enhanced PLP(s) using MIMO.

In a Layered MIMO Type B system, such as shown in Figure O.1.3, MIMO precoding can be applied exclusively to Enhanced PLPs.

Layered MIMO processing shall not be applied to Bootstraps or to Preambles. Layered MIMO processing shall be applied to Subframes individually according to the **L1D_mimo**, **L1D_mimo_mixed** (or **L1B_first_sub_mimo**, **L1B_first_sub_mimo_mixed**), and **L1D_plp_layer** settings carried in the Preamble of each Frame (see Section O.14 for details).

O.2 FEC CODING

The same FEC codes as in Section 6.1 shall be used for Layered MIMO.

O.3 BIT INTERLEAVING

The same bit interleavers as in Section 6.2 shall be used for Layered MIMO.

O.4 CONSTELLATION MAPPING

The same MIMO mappers as in Section L.4 shall be used for Layered MIMO. For SISO PLPs in Layered MIMO Type B, the same constellation mappers as in Section 6.3 shall be used.

In the case of Layered MIMO Type A, both the Core Layer and Enhanced Layer apply MIMO mapping, producing two data cell streams each.

In the case of Layered MIMO Type B, the SISO constellation mapper within the Core Layer BICM chain is situated in the same position as the MIMO mapper within the Enhanced Layer BICM chain.

O.5 PRECODING

MIMO precoding in Layered MIMO shall be applied according to Section L.5.

For Layered MIMO Type A, both Core and Enhanced PLPs undergo MIMO precoding procedures. For Layered MIMO Type B, only Enhanced PLP(s) undergo the MIMO precoding process.

For reduced complexity at the receiver, Layered MIMO Type A shall apply to an Enhanced PLP the same I/Q Polarization Interleaving and Phase Hopping parameters as the associated Core PLP(s). That is, if a Core PLP enables I/Q Polarization, the associated Enhanced PLP(s) shall also enable I/Q Polarization, and vice versa. The same constraint applies to Phase Hopping.

O.6 LDM COMBINING: CONSTELLATION SUPERPOSITION FOR LDM

LDM Combining for Layered MIMO is carried out according to Section 6.4, while the detailed application differs between Type A and Type B.

O.6.1 Constellation Superposition for Layered MIMO Type A

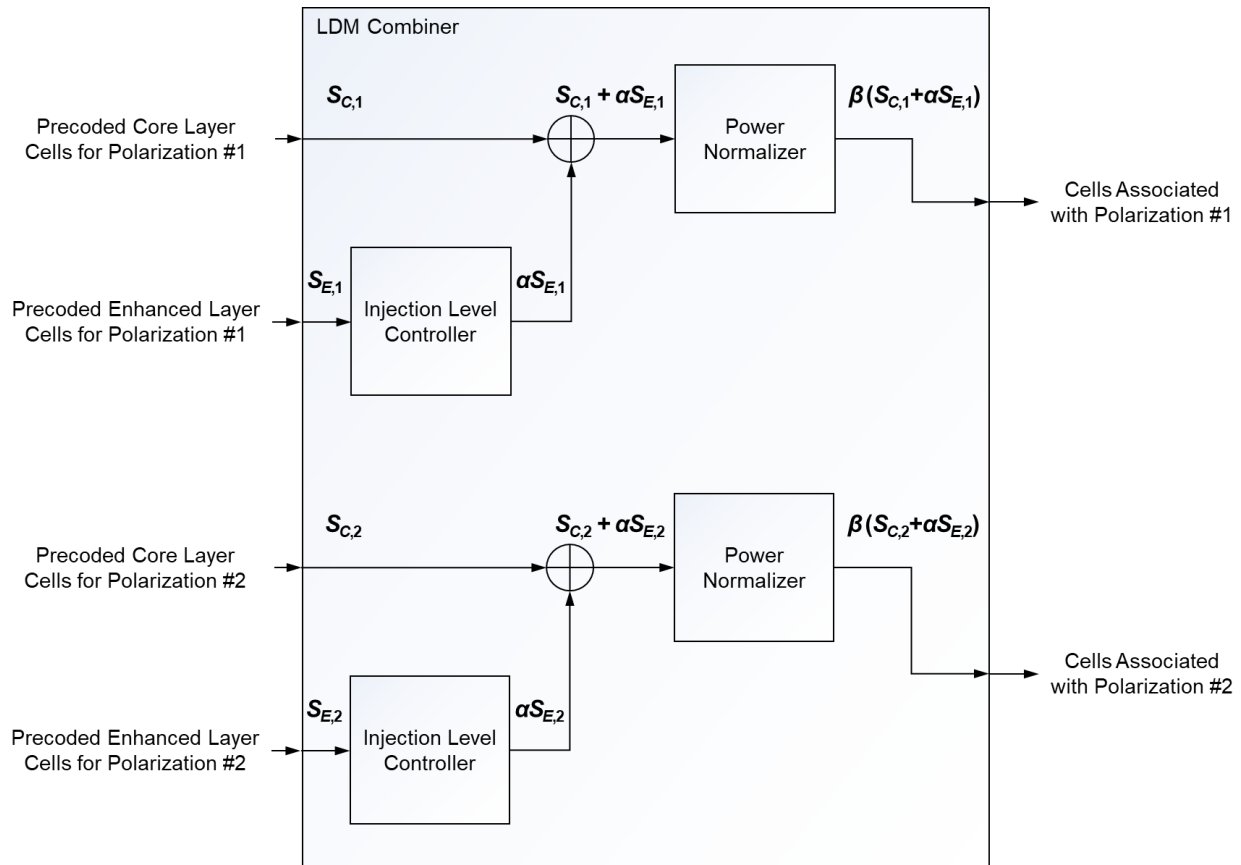

Figure O.6.1 Constellation superposition for Layered MIMO Type A.

Layered MIMO Type A shall combine Core and Enhanced PLPs that both use MIMO. In this configuration, the Core Layer and Enhanced Layer constellations associated with each Polarization are superposed in an LDM Combiner block. The constellation superposition shall be applied to MIMO-precoded cells (regardless of whether the MIMO precoding functions are active or not), as the LDM Combining block depicted in Figure O.1.2 resides after MIMO precoding blocks. The LDM Combiner block for LDM MIMO Type A is depicted in Figure O.6.1.

Two parallel injection level controllers shall be used for each associated Polarization. The Layered MIMO system assigns the same injection level to each stream for the two Polarization streams involved. The allowed values for per-Polarization injection level and the corresponding power distributions between layers shall conform to the lookup table in Table 6.15.

In Layered MIMO Type A, descriptions for CL power, EL power, total power, and their ratios in Table 6.15 shall be interpreted as quantities confined to each Polarization transmission.

The correspondence between the allowed injection level values and scaling/normalizing parameters (i.e., α and β) shall conform to the lookup table in Table 6.16.

O.6.2 Constellation Superposition for Layered MIMO Type B

Layered MIMO Type B shall transmit the Core Layer signal over Polarization #1 alone.

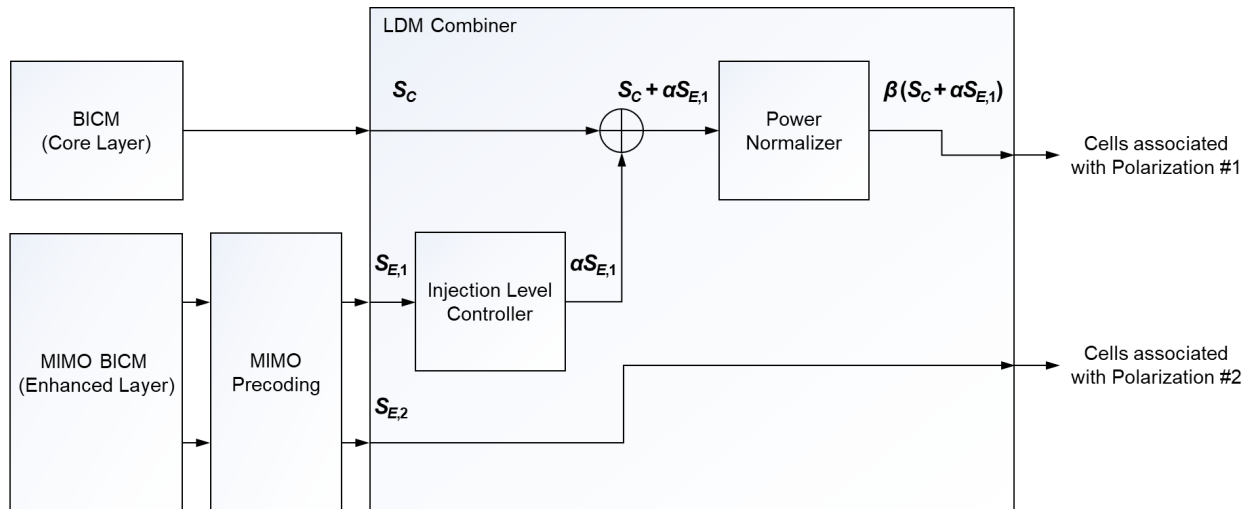

Figure O.6.2 Constellation superposition for Layered MIMO Type B.

In Layered MIMO Type B, the constellation-superposed signals shall be transmitted only in Polarization #1, while Polarization #2 shall carry the dedicated MIMO stream consisting solely of the Enhanced Layer cells.

If Layered MIMO Type B is used, constellation superposition is applied between the following two: The output of SISO BICM chain and Polarization #1 part of the output from MIMO precoder. The post-MIMO precoder cells associated with Polarization #2 bypass the LDM Combining block transparently. The LDM Combiner block for LDM MIMO Type B is depicted in Figure O.6.2.

LDM Combiner for Layered MIMO Type B shall use a single pair of injection level controller and power normalizer. The injection level controller and power normalizer associated with Polarization #1 stream operate the same as which described in Section O.6.1.

The scaling factor for the injection level controller, α , and the normalizing factor for the power normalizer, β , depend on the injection level of the Enhanced Layer. Values allowed and the correspondence among the parameters shall conform with the same lookup tables as in Table 6.15 and Table 6.16. For the use of Layered MIMO Type B, descriptions for CL power, EL power, total power, and their ratios in Table 6.15 and Table 6.16 shall be interpreted as the quantities confined to each Polarization #1 transmission.

Layered MIMO Type B assigns an identical Enhanced Layer injection level to both Polarization streams but the interpretation shall differ between the Polarization streams. For Layered MIMO Type B, the injection level for Polarization #1 shall denote the power of Enhanced Layer component relative to that of the Core Layer component, specifically confining the meaning of layer components to the Polarization #1 stream. The injection level for Polarization #2 shall represent the power of Polarization #2 signal relative to that of the Core Layer component transmitted in Polarization #1.

The LDM Combiner shall output the Polarization #2 stream with unity power. The power scaling for Polarization #2 stream depending on the corresponding injection level shall be applied in the IFFT stage.

O.7 TIME INTERLEAVER

The same time interleavers as in Section 7.1 shall be used for Layered MIMO.

In both Layered MIMO Type A and B, time interleaving mode is defined for Core PLPs. The Enhanced PLP(s) follows the same time interleaving as defined for the associated Core PLP(s). The total memory requirement conforms to the description in Section L.6. Overall, time interleaving for Layered MIMO requires twice the total memory as is required for SISO.

When Combined PLP(s) applying Layered MIMO form a complete delivered product with other SISO or MIMO PLP(s) that do not use Layered MIMO, the total TI memory required for the complete delivered product shall be twice the amount specified in Section 7.1.2. Simultaneously, the group of PLPs comprising all SISO PLPs (including Core PLPs in Layered MIMO Type B), within this complete delivered product shall individually satisfy the TI memory constraint specified in Section 7.1.2.

Extended interleaving mode shall not be used for Layered MIMO.

O.8 FRAMING

Layered MIMO Frames shall be built in the same manner with MIMO Frames, according to Section 7.2. The LDM-combined cells in Layered MIMO are treated identically to cells in SISO or non-LDM MIMO systems.

Every data cell in a Layered MIMO PLP shall not be allocated to any cells in Preamble symbol(s), even if there are available parts remaining in the last Preamble symbol.

The cell multiplexing in Layered MIMO shall follow the same process as MIMO cell multiplexing described in Section L.7. The number of available data cells for cell multiplexing can be obtained from tables in Section 7.2.6. Equivalent SISO pilot patterns that have the same number and position as those of MIMO scattered pilot patterns shall be used for table lookup. Equivalent SISO scattered pilot patterns are shown in Table L.9.2.

Dummy modulation value insertion for Layered MIMO subframes shall comply with Section 7.2.6.5 and Section L.7. The power of dummy modulation values shall match that of the actual PLP data assigned to the respective Polarizations. With Layered MIMO Type B in use, the level of dummy modulation value's transmission power shall differ between Polarizations, according to power scaling at the IFFT stage.

Subframes using Layered MIMO Type B shall not contain any Core PLP(s) that are not associated with Enhanced PLP(s).

As noted in Section 7.2.7.4.6, Core and Enhanced PLPs in a PLP group may differ in total cell count (i.e., Enhanced PLPs may not fully span the PLP group), especially when HTI mode time interleaving is in use. Layered MIMO subframes in such cases shall insert Enhanced Layer dummy modulation values to the data cell indices specified in Section 7.2.7.4.6. The insertion of Enhanced Layer dummy modulation values for Layered MIMO shall be specifically performed between the MIMO precoding and LDM Combining stages. That is, the insertion shall be applied over the cells produced at the end of the MIMO precoding stage.

The Baseband Packet scrambling sequence defined in Section 5.2.3 is used to generate Enhanced Layer dummy modulation values. This scrambling sequence shall be reinitialized for each relevant PLP group. Taken as input to the MIMO mapping block (see Section L.4), a single scrambling sequence shall be modulated into two parallel cell streams, each mapped onto the respective Polarization. Enhanced Layer dummy modulation values shall use the same constellation as the last Enhanced PLP in the PLP group. Note that indexing of the produced cells follows Section L.4.1, except that it continues until the end of each scrambling sequence. The produced cell pairs shall then undergo MIMO precoding, applying the same configuration as the last Enhanced PLP in the PLP group. Subsequent system procedures applied to the precoded cells

(e.g., LDM Combining and IFFT) shall use the same parameters and configurations, including the injection level, as used for the preceding Enhanced PLP.

O.9 FREQUENCY INTERLEAVING

The same frequency interleavers as in Section 7.3 shall be used for Layered MIMO.

O.10 PILOT PATTERNS

O.10.1 Pilot Polarization Encoding

Pilot encoding for Layered MIMO shall be organized according to Section L.9.2.11.

For Layered MIMO Type A, either Walsh-Hadamard encoding or null pilot encoding can be used. Pilot signals shall be shared Polarization-wise between the Core Layer and Enhanced Layer.

For Layered MIMO Type B, only Walsh-Hadamard encoding is allowed. If superposed by means of Layered MIMO Type B, SISO PLP(s) and MIMO PLP(s) shall share the pilot cells transmitted in Polarization #1. Pilot schemes using Walsh-Hadamard encoding achieve such pilot compatibility, as summarized in Table L.9.1. The L1 signaling parameter **L1B_mimo_scattered_pilot_encoding** shall hence be identified as 0, indicating both the MIMO pilot pattern with Walsh-Hadamard encoding and the SISO pilot pattern simultaneously (see Table 9.3). This indication may be interpreted differently depending on which PLP(s) is being received.

O.10.2 Pilot Schemes

The same scattered pilot patterns as in Section L.9.2 shall be applied to Layered MIMO.

O.11 MISO

The use of MISO, as described in Section 8.2 may be optionally added to Layered MIMO with a unique MISO code applied per station or per Polarization.

If Layered MIMO Type B and MISO are used together, a MIMO transmitter shall apply different MISO code indices to Polarizations #1 and #2.

O.12 IFFT

IFFT in Layered MIMO follows the definitions and descriptions in Sections 8.3 and L.11 but with a partial modification. The same OFDM structures as in Section 8.3 shall be used for each Polarization stream in MIMO transmission.

To embrace MIMO formulation and different types of LDM Combining, Layered MIMO uses a post-IFFT signal description modified from that in Section 8.3. In a Layered MIMO system, the baseband time domain signal after IFFT shall be described for each Polarization by the following expression:

$$\sum_{l=0}^{L_{FP}-1} \frac{K_0[a]}{\sqrt{P'_{preamble,a,l}}} \sum_{k=0}^{NoC_{P,l}-1} c_{l,k} \times \psi_{l,k}(t) + \sum_{m=0}^{N_{SF}-1} \frac{K_m[a]}{\sqrt{P'_{data,a,m}}} \sum_{l=0}^{L_{SFm}-1} \sum_{k=0}^{NoC_{m}-1} c_{a,m,l,k} \times \psi_{m,l,k}(t)$$

where $\psi_{l,k}(t)$ and $\psi_{m,l,k}(t)$ follow the definitions in Section 8.3, and:

- a denotes the Polarization index, where $a = 0$ and $a = 1$ indicates Polarizations #1 and #2, respectively;

k	denotes the carrier number;
l	denotes the OFDM symbol number starting from 0 for the first Preamble symbol of a Frame and being reset at the first OFDM symbol of each Subframe;
m	denotes the Subframe number, $0 \leq m < N_{SF}$;
$K_m[a]$	is the scaling coefficient subject to Subframe number m and Polarization index a . The value of $K_m[a]$ is related to the injection level information as summarized in Table O.12.1;
$c_{l,k}$	is the complex modulation value for carrier k of the Preamble symbol number l ;
$c_{a,m,l,k}$	is the complex modulation value for carrier k of the OFDM symbol number l in Subframe number m associated with Polarization a ;
$NoC_{P,l}$	denotes the number of carriers in the $(l + 1)^{th}$ Preamble symbol. The first Preamble symbol ($l = 0$) always has the minimum NoC and the following Preamble symbols ($0 < l < L_{FP}$) share the same NoC value that is signaled in L1-Basic as explained in Sections 7.2.5.1 and 9.2.2;
NoC_m	denotes the number of carriers of Subframe m as defined in Table 8.8;
L_{SFm}	is the number of data and Subframe boundary symbols in Subframe m ;
L_{FP}	is the number of OFDM symbols in the Preamble;
N_{SF}	is the number of Subframes in a Frame;
$P'_{preamble,a,l}$	is the frequency domain total power of the $(l + 1)^{th}$ Preamble symbol, derived from the input to the IFFT block associated with Polarization a ;
$P'_{data,a,m}$	is the frequency domain total power of each data and Subframe boundary symbol in Subframe m , derived from the input to the IFFT block associated with Polarization a .

Two parallel IFFT functional blocks shall generate baseband time domain signals for each Polarization stream.

Given the complex modulation values $c_{l,k}$ and $c_{a,m,l,k}$ as input, the IFFT blocks for Layered MIMO shall perform a power scaling dependent on scalar coefficients $K_m[a]$. Allowed values of $K_m[a]$ and the correspondence to the injection level are listed in Table O.12.1. This scaling gives $K_m[1] < 1$ to the Polarization #2 stream in Layered MIMO Type B, while $K_m[a]$ shall be given as unity otherwise. The IFFT power normalization in Layered MIMO shall normalize the symbol-by-symbol average power of the baseband time domain signal to $(K_m[a])^2$ for Subframe m subject to Polarization a . For the Preamble, the average power shall be normalized to $(K_0[a])^2$. This power normalization is achieved by applying the IFFT power normalization factor $1/\sqrt{P'_{preamble,a,l}}$ to the Preamble and $1/\sqrt{P'_{data,a,m}}$ to data and Subframe boundary symbols. The frequency domain power parameters $P'_{preamble,a,l}$ and $P'_{data,a,m}$ are derived from the carrier signals unscaled by $K_m[a]$, i.e., the values $c_{l,k}$ and $c_{a,m,l,k}$. The frequency domain power parameter for the Preamble, $P'_{preamble,a,l}$, shall share the same lookup table with $P_{preamble,l}$ described in Table I.1.1. The frequency domain power parameter for data and Subframe boundary symbols, $P'_{data,a,m}$, shall share the same lookup table with $P_{data,m}$ described in Table I.2.1 to Table I.2.5.

The same elementary period and OFDM parameters as in Section 8.3 shall be used for Layered MIMO, using the lookup Table 8.7 and Table 8.8.

Table O.12.1 Scaling Factors According to Enhanced Layer Injection Level in Layered MIMO

(Per-Polarization) Injection Level of EL below CL [dB]	Km[a]		
	Type A	Type B	
	a = 0, 1	a = 0	a = 1
0.0	1.0000000	1.0000000	0.7071068
0.5	1.0000000	1.0000000	0.6864761
1.0	1.0000000	1.0000000	0.6653483
1.5	1.0000000	1.0000000	0.6438178
2.0	1.0000000	1.0000000	0.6219832
2.5	1.0000000	1.0000000	0.5999458
3.0	1.0000000	1.0000000	0.5778067
3.5	1.0000000	1.0000000	0.5556652
4.0	1.0000000	1.0000000	0.533617
4.5	1.0000000	1.0000000	0.5117528
5.0	1.0000000	1.0000000	0.4901561
6.0	1.0000000	1.0000000	0.4480625
7.0	1.0000000	1.0000000	0.4078450
8.0	1.0000000	1.0000000	0.3698742
9.0	1.0000000	1.0000000	0.3343887
10.0	1.0000000	1.0000000	0.3015114
11.0	1.0000000	1.0000000	0.2712703
12.0	1.0000000	1.0000000	0.2436204
13.0	1.0000000	1.0000000	0.2184644
14.0	1.0000000	1.0000000	0.1956693
15.0	1.0000000	1.0000000	0.1750812
16.0	1.0000000	1.0000000	0.1565355
17.0	1.0000000	1.0000000	0.1398653
18.0	1.0000000	1.0000000	0.1249066
19.0	1.0000000	1.0000000	0.1115021
20.0	1.0000000	1.0000000	0.0995037
21.0	1.0000000	1.0000000	0.0887732
22.0	1.0000000	1.0000000	0.0791834
23.0	1.0000000	1.0000000	0.0706179
24.0	1.0000000	1.0000000	0.0629705
25.0	1.0000000	1.0000000	0.0561454

The expression above shall be used when the entire Frame uses Layered MIMO. If a Layered MIMO Subframe is time division multiplexed with Subframes not using Layered MIMO, the IFFT processing shall conform to Section O.12.1.

O.12.1 Coexistence with SISO or MIMO Subframes

Layered MIMO Subframes can be time division multiplexed with other types of Subframes not using Layered MIMO. In this TDM case, the baseband time domain signal after IFFT shall be described by the following per-Polarization expression:

$$\sum_{l=0}^{L_{FP}-1} \frac{K_{S_{M,a}(0)}[a]}{\sqrt{P'_{preamble,a,l}}} \sum_{k=0}^{N_{OC,l}-1} c_{l,k} \times \psi_{l,k}(t) + \sum_{\substack{m=0 \\ m \in S_{M,a}}}^{N_{SF}-1} \frac{K_m[a]}{\sqrt{P'_{data,a,m}}} \sum_{l=0}^{L_{SFm}-1} \sum_{k=0}^{N_{OCm}-1} c_{a,m,l,k} \times \psi_{m,l,k}(t)$$

where:

$S_{M,a}$ denotes the set of Subframe numbers, for which Polarization a is active during the transmission of those subframes;

and the other related parameters share definitions in the previous expression in Section O.12.

To clarify the processing on SISO and non-LDM MIMO elements, the following conditioned descriptions for related parameters are specified:

$K_m[a]$ satisfies $K_m[a] = 1$ if Subframe m is not Layered MIMO;

For each Polarization, the power of Preamble symbol references the data symbol power of the first Subframe activating the corresponding Polarization. This is indicated by the scaling factor $K_{S_{M,a}(0)}[a]$, where $S_{M,a}(0)$ denotes the first element of $S_{M,a}$. The subframes shall be arranged in descending order of the scaling factor $K_m[1]$.

Transmission of pure SISO Subframes at the Layered MIMO transmitter can choose between two different Polarization selection schemes summarized in Section L.11.2. The possible options for Polarization selection are as follows:

- Option 1: Polarization #1 transmits SISO Subframes while Polarization #2 is inactive during those subframes.
- Option 2: Polarizations #1 and #2 transmit identical signal copies of SISO Subframes.

The realization of $S_{M,a}$ shall vary depending on the selected Polarization mapping option. If Option 1 is applied, $S_{M,a}$ shall be determined as follows:

$S_{M,0}$ consists of every integer within $0 \leq m < N_{SF}$, i.e., $S_{M,a} = \{0, \dots, N_{SF} - 1\}$;

$S_{M,1}$ consists of the Subframe numbers that use MIMO or Layered MIMO.

If Option 2 is applied, $S_{M,a}$ and $c_{a,m,l,k}$ shall be determined as follows:

$S_{M,a}$ consists of every integer within $0 \leq m < N_{SF}$, i.e., $S_{M,a} = \{0, \dots, N_{SF} - 1\}$, irrespective to the value of a .

$c_{a,m,l,k}$ satisfies $c_{0,m,l,k} = c_{1,m,l,k}$ if Subframe m is SISO.

O.13 CHANNEL BONDING

When used, channel bonding with Layered MIMO shall conform to the description in this section. The same Input Formatting, Stream Partitioning, and Cell Exchange operations as defined in Annex K and Section L.13 shall be applied, while details specific to Layered MIMO are added in this Section. A block diagram in Figure O.14.1 illustrates the system architecture applying channel bonding and Layered MIMO simultaneously.

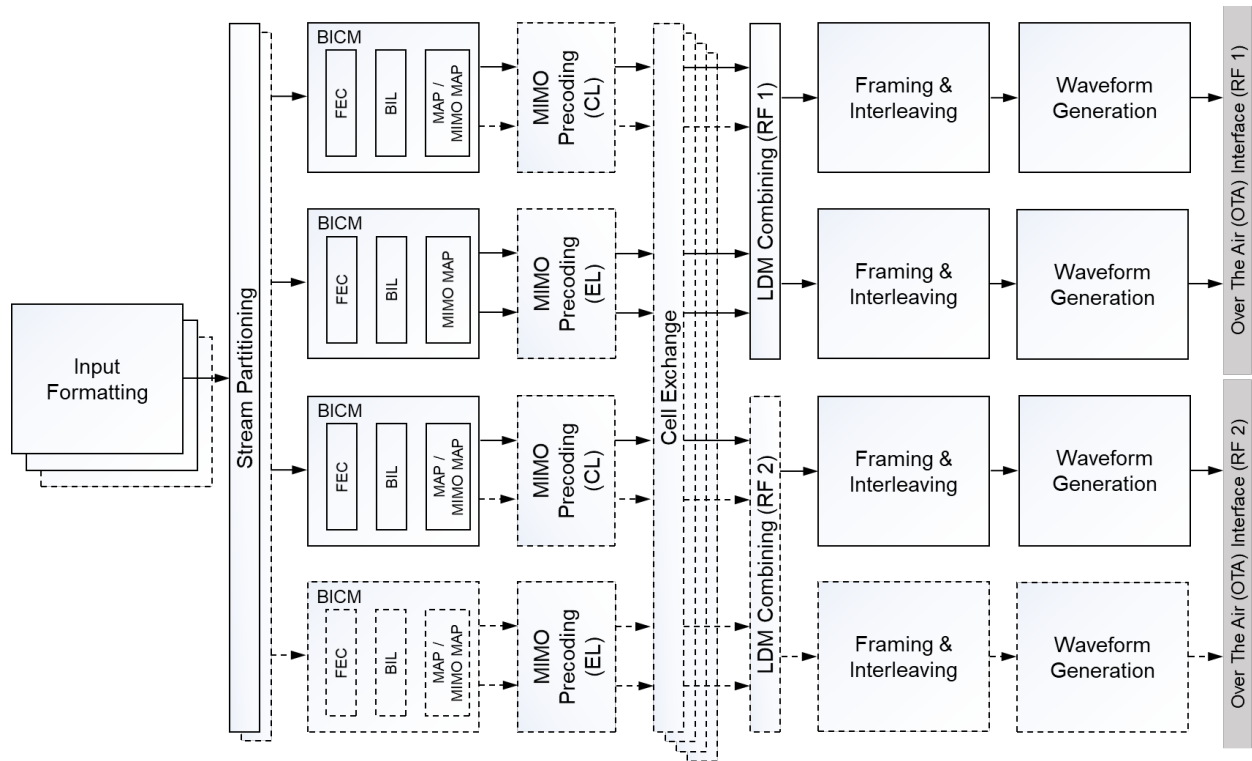

Figure O.13.1 Comprehensive block diagram of Layered MIMO with channel bonding.

Not all blocks are used in every configuration. In Figure O.13.1, solid lines denote blocks common to all configurations, while dashed lines indicate blocks that can be disabled depending on configurations related to LDM, MIMO, and channel bonding. Solid arrows represent signal flows common to all configurations, whereas dashed arrows denote optional signal flows that may be absent depending on the configuration.

For a channel-bonded PLP, all data packets engaged shall pass through a common Input Formatting block (utilizing the same `L1D_plp_id` value on every associated RF channel), as described in Section K.1. Baseband Packets generated by the Input Formatting block dedicated to a channel-bonded PLP shall be split across two parallel streams at the Stream Partitioning block. Baseband Packets unrelated to channel bonding shall bypass Stream Partitioning.

Plain channel bonding and SNR averaging are both available for channel bonding with Layered MIMO. The related cell/PLP multiplexing shall follow Section K.4. Whenever channel bonding with SNR averaging is used, the bonded streams originating in the same Input Formatting block shall be contained in the same LDM layer.

If enabled, cell exchange processing shall be applied over the cells produced at the end of the MIMO precoding stage: MIMO-precoded (regardless of whether the MIMO precoding functions are active or not) cells for MIMO PLP(s) and post-BICM cells for SISO PLP(s). The cell exchange processing described in Section L.13 and Section K.3 shall be applied to MIMO PLP's and SISO PLP's cells, respectively.

The output streams from cell exchange blocks shall go through LDM Combining between each coupled stream pair, i.e., Core and Enhanced Layer cells that belong to the same Polarization. The LDM Combining process shall conform to the specifications in Sections 6.4 and O.6.

When a channel-bonded PLP with SNR averaging is included, Layered MIMO configurations for the bonded RF channels shall be identical between the corresponding subframes (each in a different RF channel). The type of Layered MIMO (i.e., whether Type A or B) and injection level shall be identical. MIMO parameters and layer indices shall be identical as well. Note that individual PLPs in a Combined PLP can independently configure the use and format of channel bonding, meaning it does not need to be applied simultaneously. Other configuration constraints under the use of SNR averaging shall follow the same specification in Section K.3.

When plain channel bonding is used, the type of Layered MIMO, layer index, injection level, and other Layered MIMO parameters may differ between the engaged PLPs in different RF channels. Other scheduling parameters may also differ, as described in Section K.3. Accordingly, plain channel bonding with Layered MIMO does not restrict channel bonding to a homogeneous PLP pair. A channel-bonded PLP may comprise a SISO PLP and a MIMO PLP, and part of a Layered MIMO subframe may be bonded with one not using Layered MIMO.

O.14 L1 SIGNALLING FOR LAYERED MIMO

This section highlights the L1 signaling data specific to Layered MIMO defined in Section 9.

L1B_first_sub_mimo indicates whether MIMO is applied to every Core PLP in the first Subframe of the current Frame.

L1D_mimo indicates whether MIMO is applied to every Core PLP in the current Subframe, which is the second or later in the given Frame.

For the first Subframe of the current Frame, the type of Layered MIMO is signaled by **L1B_first_sub_mimo_mixed** in conjunction with **L1B_first_sub_mimo** when PLP(s) with **L1D_plp_layer** >0 are present in the Subframe. Layered MIMO Type A is indicated when the two parameters are signaled as **L1B_first_sub_mimo_mixed** =0, **L1B_first_sub_mimo** =1. Layered MIMO Type B is indicated when the two parameters are signaled as **L1B_first_sub_mimo_mixed** =1, **L1B_first_sub_mimo** =0.

For Subframes that are not the first in the current Frame, the type of Layered MIMO is signaled by **L1D_mimo_mixed** in conjunction with **L1D_mimo** when PLP(s) with **L1D_plp_layer** >0 are present in the Subframe. Layered MIMO Type A is indicated when the two parameters are signaled as **L1D_mimo_mixed** =0, **L1D_mimo** =1. Layered MIMO Type B is indicated when the two parameters are signaled as **L1D_mimo_mixed** =1, **L1D_mimo** =0.

The parameters in the **L1D_version** >= 2 loop (**L1D_plp_mimo**, **L1D_plp_mimo_stream_combining**, **L1D_plp_mimo_IQ_interleaving** and **L1D_plp_mimo_PH**) shall apply to the **L1D_plp_mimo** in the same order as signaled in the **L1D_version** >= 1 loop.

Note: This version of the specification allows only LDM-based mixing of SISO and MIMO PLPs for Subframes with **L1B_first_sub_mimo_mixed** =1 and **L1B_first_sub_mimo** =0, or **L1D_mimo_mixed** =1 and **L1D_mimo** =0 (as appropriate for the given Subframe). Future versions may specify additional multiplexing options for mixed use of MIMO mode (e.g., all PLPs having **L1D_plp_layer** =0) within a Subframe (see Table 9.8 and Table 9.10).

In subframes using Layered MIMO Type B, every Core PLP shall be associated with one or more Enhanced PLPs. Specifically, in any subframe indicated by **L1D_mimo_mixed** or **L1B_first_sub_mimo_mixed**, no Core PLP shall have its **L1D_plp_start** equal to or greater than the maximum value of **L1D_plp_start** + **L1D_plp_size** among all Enhanced PLPs present in the subframe; and no Core PLP shall have its **L1D_plp_start** + **L1D_plp_size** equal to or less than the minimum **L1D_plp_start** among all Enhanced PLPs present in the subframe.

In Subframes using Layered MIMO Type B, **L1D_plp_mimo** indicates whether each PLP is in MIMO mode. For the current version of the specification, Layered MIMO Type B shall assign **L1D_plp_mimo** =0 to Core PLPs and **L1D_plp_mimo** =1 to Enhanced PLPs.

The layer index of each PLP is signaled by **L1D_plp_layer**. Core and Enhanced PLPs are identified by **L1D_plp_layer** =0 and **L1D_plp_layer** >0, respectively. The use of Layered MIMO involves the presence of PLP(s) having **L1D_plp_layer** >0 in the corresponding Subframe.

Within a subframe using Layered MIMO Type B, all Enhanced PLPs shall apply the same value **L1D_plp_idm_injection_level**.

The choice of scattered pilot encoding scheme is signaled by **L1B_mimo_scattered_pilot_encoding**, which applies to every Layered MIMO Subframe in the current Frame. The interpretation of this field is defined in Table 9.3. If Layered MIMO Type A is used, **L1B_mimo_scattered_pilot_encoding** can either be 0 or 1. If Layered MIMO Type B is used, **L1B_mimo_scattered_pilot_encoding** shall be signaled as 0. When both SISO and Layered MIMO subframes are present in the current frame, the SISO subframe shall conform to the pilot insertion process as detailed in Section 8.1 regardless of the value of **L1B_mimo_scattered_pilot_encoding**.

The configuration of MIMO precoding is signaled by a set of L1-Detail parameters, **L1D_plp_mimo_stream_combining**, **L1D_plp_mimo_IQ_interleaving**, and **L1D_plp_mimo_PH**.

The choice of Enhanced Layer injection level is signaled by **L1D_plp_idm_injection_level**. For Layered MIMO Type A, the injection level denotes the relative power ratio between the Enhanced Layer and Core Layer signals within each Polarization stream. For Layered MIMO Type B, the interpretation shall differ between Polarization streams as follows: The injection level in the context of Polarization #1 refers to the relative power ratio between the Enhanced Layer and Core Layer within Polarization #1 signal; the injection level with respect to Polarization #2 refers to the power of Polarization #2 signal relative to that of the Core Layer signal transmitted in Polarization #1.

The choice of scattered pilot pattern is signaled by **L1B_first_sub_scattered_pilot_pattern** for the first Subframe and by **L1D_scattered_pilot_pattern** for other Subframes in the current Frame. These signaling parameters should be interpreted differently in SISO and MIMO contexts. When Layered MIMO Type B is used, two different interpretations are simultaneously intended by a single use of this signaling parameter. In the case of Layered MIMO Type B, the Core Layer receivers may interpret these signaling parameters in a SISO-related manner, while the Enhanced Layer receivers shall interpret them in a MIMO-related manner.

The choice of the bits per cell use for MIMO PLP(s) is signaled by **L1D_plp_mod**. This signaling parameter is also used for SISO but with a different interpretation.

The L1-Detail parameters **L1D_num_rf**, **L1D_rf_id**, **L1D_bonded_bsid**, **L1D_bsid**, **L1D_plp_num_channel_bonded**, **L1D_plp_bonded_rf_id**, and **L1D_plp_channel_bonding_format** shall signal the configuration related to channel bonding when channel bonding is used with Layered MIMO.

— End of Document —